



Manufacturers and Exporters of
Fine Quality
Surgical Instruments,



www.seasoned.pk



Surgical
Instruments
Catalogue

Table Of Contents















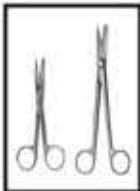

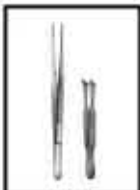
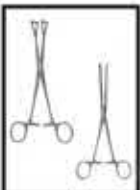
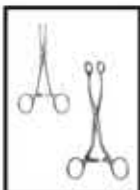
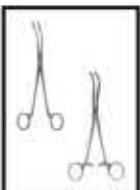
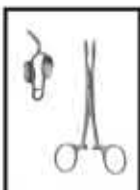

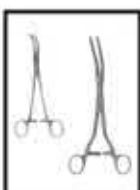

Diagnostic, Anaesthesia and other instruments	Page Seite		Probes, Pocket Instruments sets	Page Seite	
Diagnostyka, Anestezjologia, Narzędzia różne	1 - 10		Zgłębniki i zestawy narzędzi	66 - 68	
Scalpels, knives and Scalpel Handles			Wound Retractors		
Skalpele, nożyki i uchwyt do skalpeli	11 - 14		Haki do ran	69 - 80	
Scissors			Self-Retaining Retractors, Abdominal Retractors		
Nożyczki	15 - 31		Haki samo trzymające, haki brzuszne	81 - 85	
Dissecting-and Tissue Forceps			Abdominal Surgery Intestinal-and Rectal Instruments		
Pincety preparacyjne i chirurgiczne	32 - 42		Chirurgia brzuszna, narzędzia jelitowe i rektalne	86 - 93	
Sponge, Dressing and Tissue Grasping Forceps Towel Clamps			Gall Bladder-, Liver-and Spleen Instruments		
Pincety do tamponowania, anatomiczne, Chirurgiczne chwytające, spinaki	43 - 48		Narzędzia do kamieni żółciowych, wątroby, śledziony	94 - 96	
Vessel Clips, Bulldog Clamps Haemostatic Forceps			Genito-Urinary Instruments and Trocars		
Zaciski do naczyń, kłamy typ Bulldog, Kleszczyki naczyniowe	49 - 57		Narzędzia urologiczne, trokary	97 - 100	
Ligature, Hysterectomy and Compression Forceps Vaginal Clamps			Vaginal Specula and Uterine Dilators		
Narzędzia do ligatury Narzędzia do macicy, kleszcze ściskające, kleszcze dopochwowe	58 - 60		Wzierniki ginekologiczne i rozszerzacze	101 - 106	
Needle Holders, Suture Instruments			Uterine Probes, Uterine Dressing-, Polypus-and Ovum Forceps		
Igłotrzymacze, narzędzia do szycia	61 - 65		Zgłębniki maciczne, kleszczyki do polipów i jajeczek	107 - 109	

Table Of Contents

	Page Seite		Page Seite	
Biopsy Instruments and Curettes				Suction Instruments
Narzędzia biopsyjne, łyżeczki	110 - 116			Narzędzia ssące
				
Obstetrics and Tracheotomy				
Położnictwo i tracheotomia	117 - 119			
				
Cardiovascular-and Thoracic Surgery				
Chirurgia naczyniowa i torakochirurgia	120 - 128			
				
Bone Punches, Rongeurs				
Przebijaki kostne i odgryzacz	129 - 134			
				
Elevators, Bone Levers, Raspatories, Bone Files, Bone Curettes				
Podważki, dźwignie, skrobaczki, pilniki, łyżeczki kostne	135 - 139			
				
Mallets, Chisels and Gouges				
Młotki, dłuta, dłuta wklęsłe	140 - 141			
				
Bone Holding Forceps, Bone Rongeurs, Bone Cutting Forceps				
Kleszcze do kości, kleszcze tnące	142 - 146			
				
Plaster Instruments				
Narzędzia do gipsu	147 - 157			

Percussion Hammers and Aesthesiometers



01-101
TROEMNER
 Size: 245 mm



01-102
DEJERINE
 Size: 200 mm



01-103
DEJERINE
 with needle
 Size: 210 mm



01-104
TAYLOR
 Size: 195 mm



01-105
BERLINER
 Size: 200 mm



01-106
BUCK
 with needle
 and brush
 Size: 180 mm



01-107
RABINER
 with needle
 and brush
 Size: 255 mm



01-108
ALY
 Size: 190 mm



01-109
WARTENBERG
 Pinwheel for
 neurological
 examination
 Size: 185 mm

Stethoscopes



01-110
 PINARD (Aluminum)
 Size: 155 mm

1/2



01-111
 wooden
 Size: 145 mm

1/2



01-112
 BOWLES
 Stethoscope
 with diaphragm

1/4



01-113
 ANESTOPHON

1/2



01-114
 FORD-BOWLES
 Dual chest piece
 with two outlets

1/4



01-115
 BOWLES

1/4

Head Mirrors and Head Bands



01-116
ZIEGLER Ø 90mm
head mirror only
with rubber coating



01-117
ZIEGLER Ø 90mm
head mirror only
with metal coating



01-118
ZIEGLER
head band of plastic black

01-119
ZIEGLER
head band of plastic white



01-120
MURPHY
head band of celluloid, white



01-121
head band of plastic,
white, soft pattern



01-122
head mirror with black
plastic head band.

Tongue Depressors

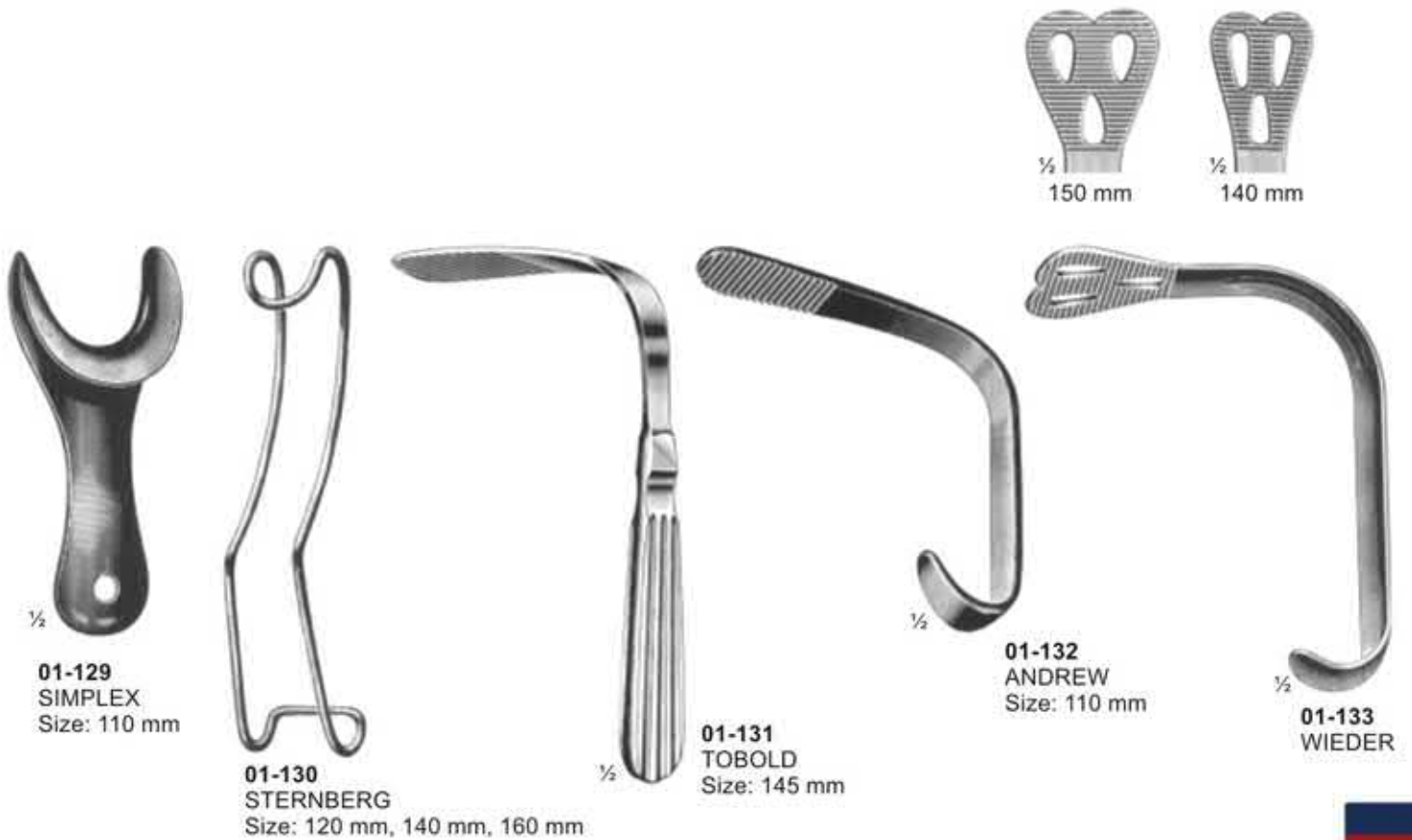
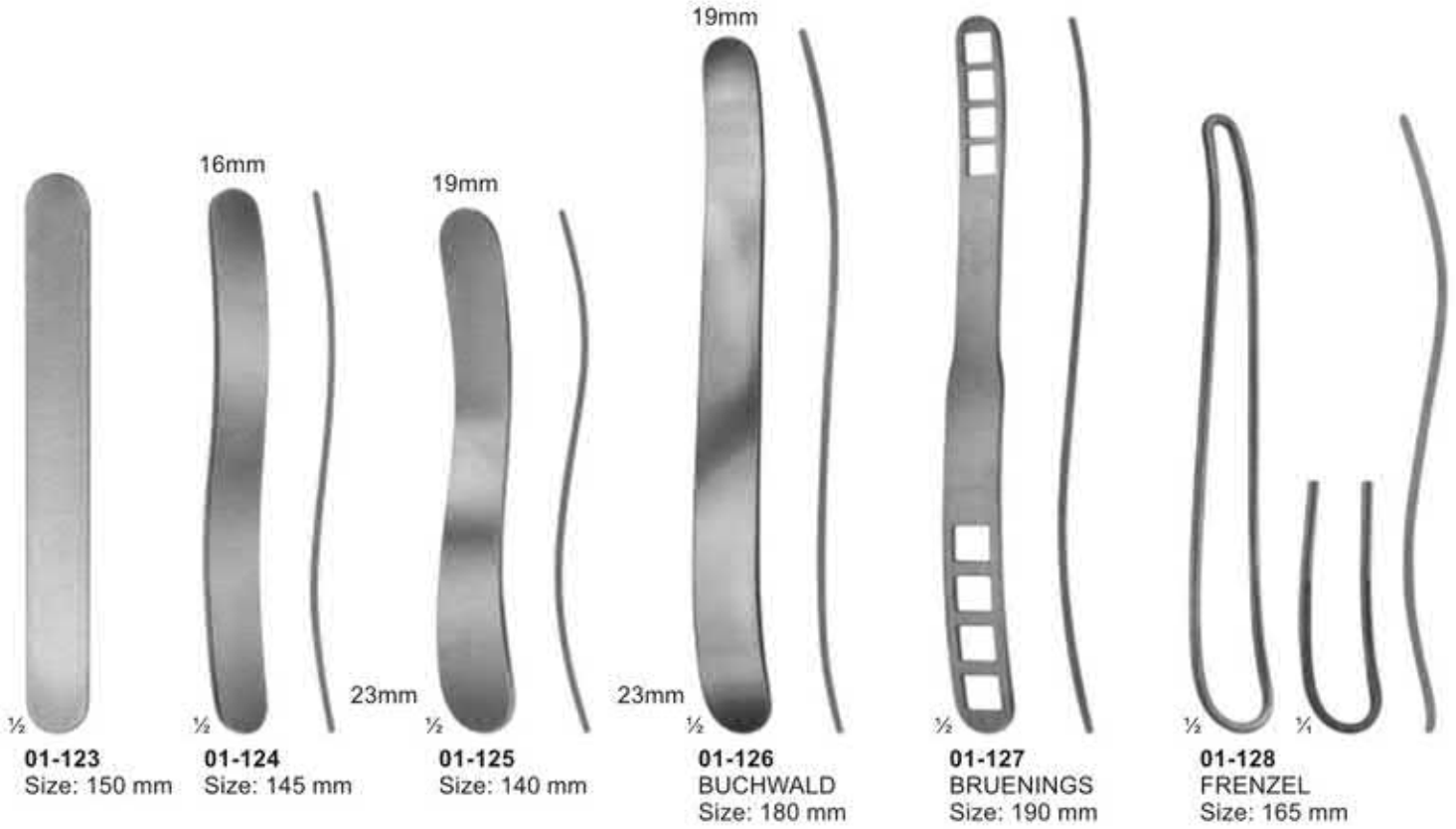

Instruments for Anaesthesia and Tongue Forceps



1/2
01-134
SCHIMMELBUSCH
 Ether mask



1/2
01-135
HEISTER
 Mouth gag
 Size: 130 mm



1/2
01-136
FERGUSSON-ACKLAND
 Mouth gag
 Size: 145 mm



1/2
01-137
DENHARDT
 Mouth gag with silicon
 inserts, interchangeable
 Size: 125 mm



1/2
01-138
ROSER KOENIG
 Mouth gag
 Size: 160 mm, 185 mm

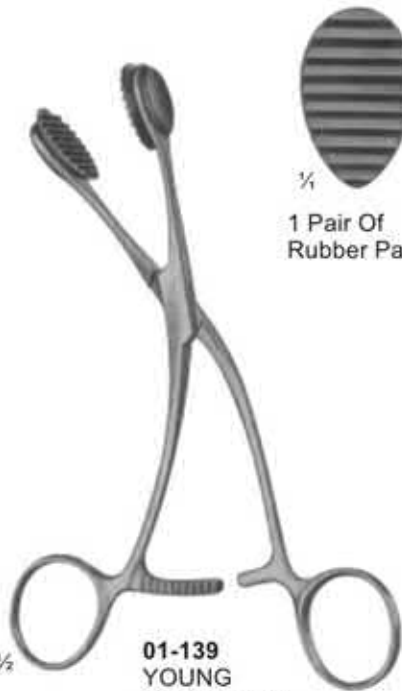

1/4
 1 Pair Of
 Rubber Pads

1/2
01-139
YOUNG
 Size: 165 mm

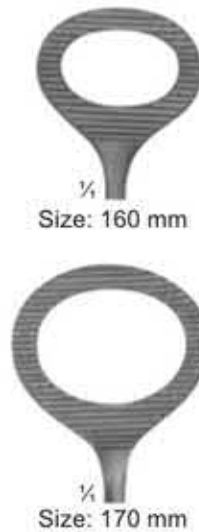
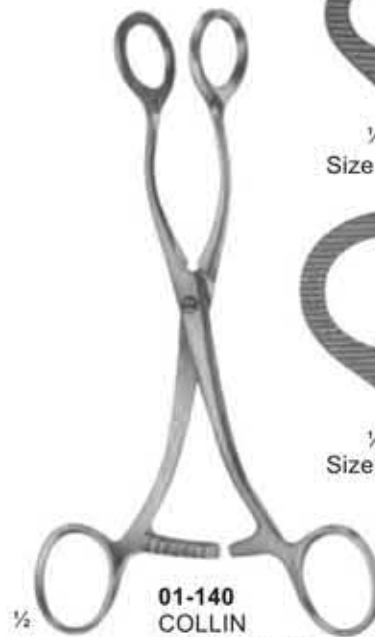

1/4
 Size: 160 mm

1/4
 Size: 170 mm

1/2
01-140
COLLIN
 Size: 160 mm,
 170 mm



1/2
01-141
HEYWOOD-SMITH
 modif. Size: 215 mm

Blood Lancets and Laryngeal Mirrors

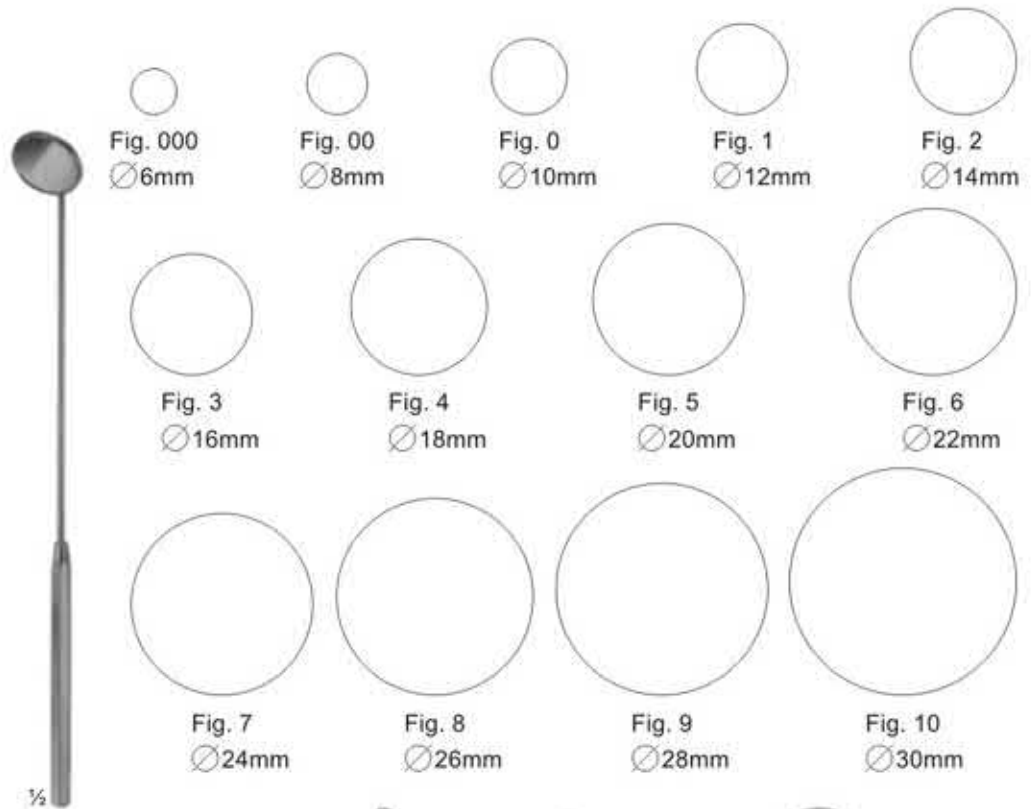

½
01-143
 Laryngeal mirrors with
 hexagonal handle
 Size: 180 mm



Diagnostic Sets



01-153
Ophthalmoscope



$\frac{1}{2}$ **01-150 - 152**
MAGILL
Catheter Introducing Forceps



$\frac{1}{2}$ **01-153-A**
Medium battery handle
only, 25 mm diam.



01-153-B
Spare bulb
2.7 volt, for
otoscopes



01-153-C
Spare bulb
2.6 volt, for
ophthalmoscopes



$\frac{1}{4}$ **01-152**
Adults
Size: 250 mm



$\frac{1}{4}$ **01-151**
Children
Size: 200 mm



$\frac{1}{4}$ **01-150**
Infants
Size: 150 mm



01-154
Otoscope & Pouch



01-155
ENT Set



01-156
ENT Set
Otoscope, consists of
battery handle without batteries,
3 ear specula, 1 bulb in valvet lined case



01-157
Otoscope Set with three specula.

Laryngoscopes



01-158
MILLER
 Laryngoscope set, consists of battery handle (without battery)
 with five miller laryngoscope blades

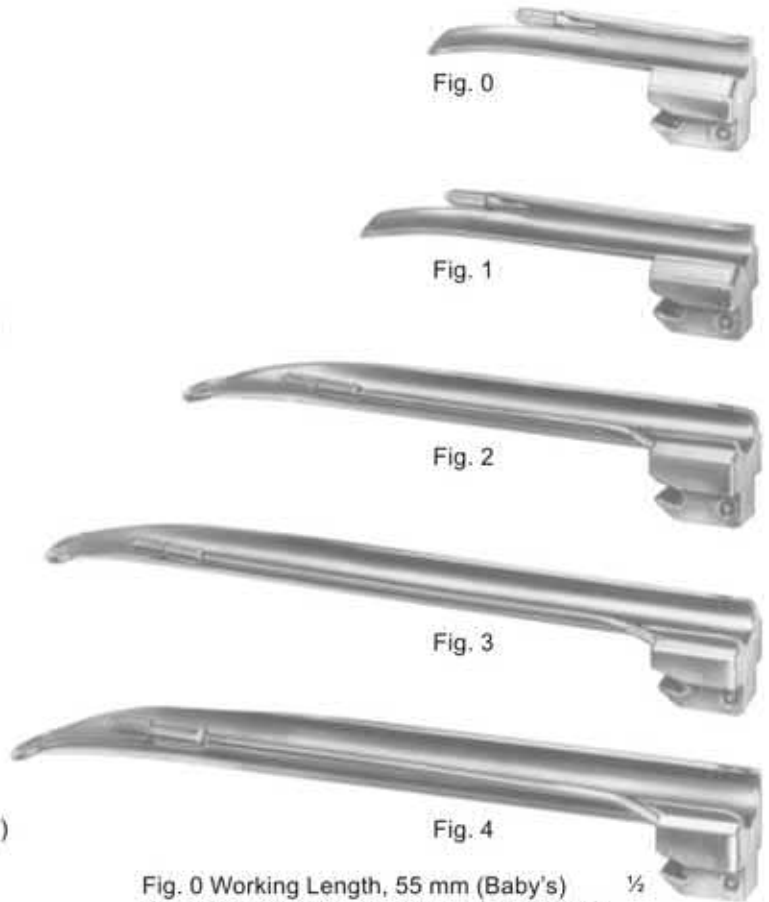

Fig. 0 Working Length, 55 mm (Baby's)
 Fig. 1 Working Length, 80 mm (Children's)
 Fig. 2 Working Length, 130 mm (Adolescent's)
 Fig. 3 Working Length, 170 mm (Women's)
 Fig. 4 Working Length, 180 mm (Men's)



01-159
GUEDEL-NEGUS
 Laryngoscope set, consists of battery handle (without battery)
 with four miller laryngoscope blades



Fig. 1 Working Length, 70 mm (Children's)
 Fig. 2 Working Length, 90 mm (Adolescent's)
 Fig. 3 Working Length, 110 mm (Women's)
 Fig. 4 Working Length, 135 mm (Men's)

Laryngoscopes



01-160
McINTOSH
Laryngoscope Set, Consists Of Battery Handle (Without Battery)
With Three McIntosh Blades, Fig. 1, Fig. 2, Fig. 3

01-161
McINTOSH
Laryngoscope Set, Consists Of Battery Handle (Without Battery)
With Five McIntosh Blades, Fig. 0, Fig. 1, Fig. 2, Fig. 3, Fig. 4

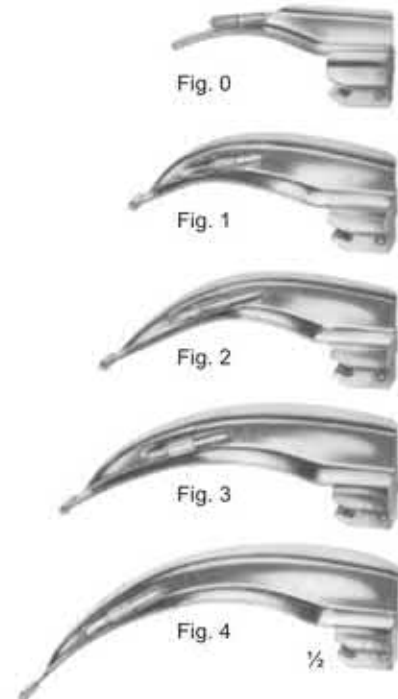

01-161 A Fig. 0 Working Length, 55 mm (Baby's)
01-161 B Fig. 1 Working Length, 75 mm (Children's)
01-161 C Fig. 2 Working Length, 90 mm (Adolescent's)
01-161 D Fig. 3 Working Length, 110 mm (Women's)
01-161 E Fig. 4 Working Length, 135 mm (Men's)

01-162
FOREGGER
Laryngoscope Set, Consists Of Battery Handle (Without Battery)
With Three Foregger Blades,
Fig. 1, Fig. 2, Fig. 3,



01-163
FOREGGER
Laryngoscope Set, Consists Of Battery Handle (Without Battery)
With Four Foregger Blades,
Fig. 1, Fig. 2, Fig. 3, Fig. 4,

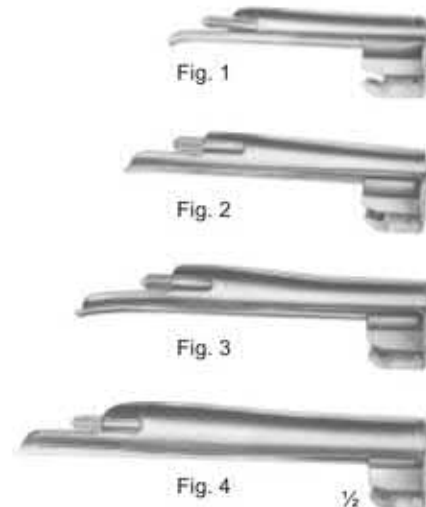

01-162 A Fig. 1 Working Length, 70 mm (Children's)
01-162 B Fig. 2 Working Length, 90 mm (Adolescent's)
01-162 C Fig. 3 Working Length, 110 mm (Women's)
01-162 D Fig. 4 Working Length, 135 mm (Men's)



01-164
Fiber Optic
Battery Handle
30mm diam.



01-165
Fiber Optic
Battery Handle
18mm diam.



01-166
Replacement Lamp
(Krypton) 2.5 V



01-167
Replacement Lamp
(Halogen) 2.5 V

Examination & Measuring Instruments



01-168
 Caliper Of Aluminium
 Graduated in mm & inches
 up to 180mm
 Measuring Range up to 139mm



01-169
 VERNIER
 Universal Caliper Of Steel
 Graduated in mm & inches
 up to 180mm
 Measuring Range up to 120mm
 with Vernier in 1/10mm & 1/16"



01-170
 CARROLL
 Size: 145 mm
 Finger Goniometer



01-171
 TOWNLEY
 Graduated in
 mm & inches
 Size: 115 mm



01-172
 COLLIN
 Druck Pressure 72 kg
 Size: 125 mm



01-173
 BERTILLON
 Caliper For Measuring The Head
 Size: 320 mm



01-174
 CASTROVIEJO
 Caliper
 Size: 75mm



01-175
 MOLTGEN
 Goniometer



01-176
 Size: 150 mm



01-177
 Size: 500 mm

Dissecting Knives



02-101 - 110
 Fig. 1 - 10



02-101
 Fig. 1
 30 mm



02-102
 Fig. 2
 36 mm



02-103
 Fig. 3
 40 mm



02-104
 Fig. 4
 45 mm



02-105
 Fig. 5
 50 mm



02-106
 Fig. 6
 27 mm



02-107
 Fig. 7
 35 mm



02-108
 Fig. 8
 40 mm



02-109
 Fig. 9
 47 mm



02-110
 Fig. 10
 50 mm

Amputating Knives, Cartilage Knives and Autopsy Knives



LISTON
02-111
Size: 130 mm
02-112
Size: 160 mm
02-113
Size: 190 mm
02-114
Size: 200 mm

02-115
CATLIN
Size: 160 mm
Blade length
Amputating
Knives

02-116
LANGENBECK
Size: 120 mm
Blade length
Flap Knives

02-117
Size: 110 mm
Blade length
Interosseous
Knives

02-118
Size: 55 mm
Blade length
with raspatory,
Wooden handle

02-119
Size: 70 mm
Blade length
Wooden handle

02-120
Size: 80 mm
Blade length
Metal handle

02-121
Size: 195 mm
Blade length
Metal handle

Blade length
Amputating Knives

Cone Knives, Myomatome, Trigeminal and Tonsil Knives



1/4

02-122
 AYRE
 Size: 235 mm
 Cone Knife

1/4

02-123
 Size: 230 mm
 Cone Knife

1/4

02-124
 SEGOND
 Size: 270 mm
 Myomatome

1/4

1/4

02-125
 OLIVECRONA
 Size: 205 mm
 Trigeminal
 Knife

1/4

02-126
 Size: 230 mm
 Trigeminal
 Knife

1/4

02-127
 FOWLER
 Size: 200 mm
 Tonsil Knife

1/4

02-128
 ABRAHAM
 Size: 215 mm
 Tonsil Knife

1/4

02-129
 BRUNINGS
 Size: 215 mm
 Tonsil Knife

Scalpel Handles



02-130
 STANDARD
 No. 3
 Solid
 12 cm

02-131
 No. 3
 Solid
 12 cm

02-132
 No. 3
 Solid
 12 cm

02-133
 No. 3 L
 Straight
 Solid
 21.5 cm

02-134
 No. 3 L
 Angled
 Solid
 21 cm

02-135
 No. 7
 Solid
 16 cm

02-136
 No. 7 K
 Solid
 12.5 cm

02-137
 Hollow-Round
 15.5 cm

02-138
 No. 3
 Straight
 Solid,
 Round
 14.5 cm

02-139
 No. 3
 Angled
 Solid,
 Round
 14 cm

Micro Scissors (Spring Type) with Flat Handles

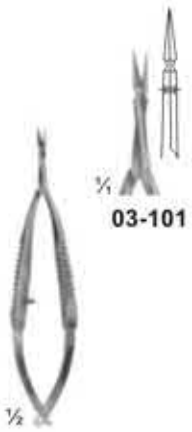

03-101 - 103
 VANNAS
 Size: 85 mm

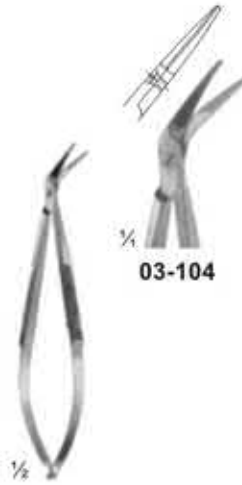

03-104 - 105
 CASTROVIEJO
 Size: 95 mm

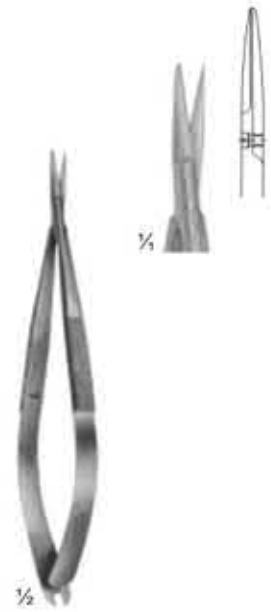

03-106
 NOYES
 Size: 125 mm

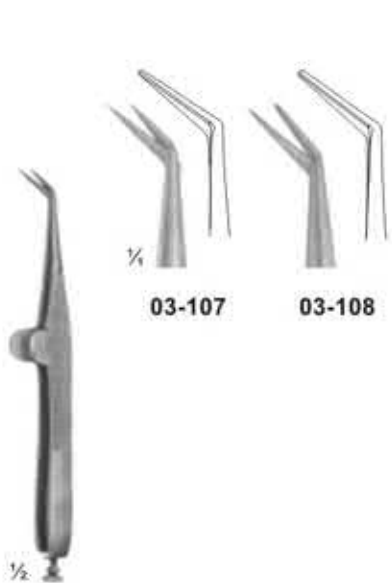

03-107 - 108
 WECKER
 Eye scissor
 Size: 110 mm



03-109
 CASTROVIEJO
 Eye scissor
 Size: 115 mm

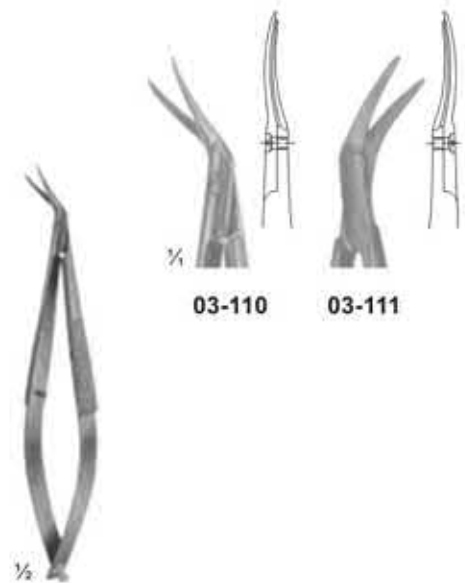

03-110 - 111
 CASTROVIEJO
 Eye scissor
 Size: 110 mm

Micro Scissors (Spring Type) with Flat Handles

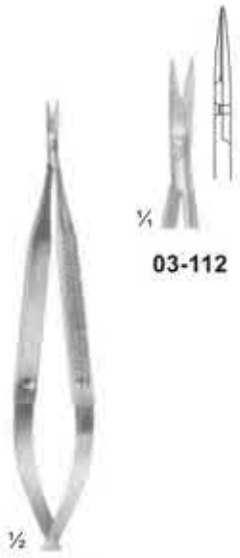

¼
03-112



03-113



¼
03-114
 BIEMER
 Vein scissor
 Size: 130 mm



¼
03-115
 Size: 160 mm



¼
03-116 - 117
 VANNAS
 Size: 160 mm



¼
03-116



¼
03-117

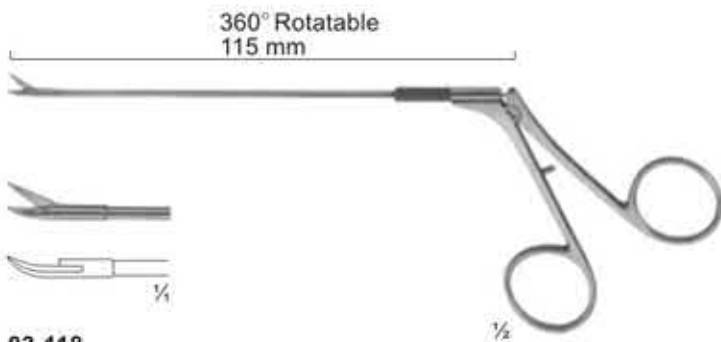

03-118
 CASPAR
 Micro scissor curved
 Size: 115 mm

360° Rotatable
 115 mm



¼
03-119 - 121
 Micro dissecting scissor
 Size: 145 mm



¼
03-119



¼
03-120



¼
03-121

Micro Scissors (Spring Type) bayonet-Shaped



03-122
 YASARGIL
 Size: 245 mm



03-123
 45°



03-124
 45°



03-123 - 124
 laterally angled
 Size: 200 mm



125°

03-125
 laterally angled
 Size: 190 mm



03-126



03-127



03-126 - 127
 YASARGIL
 Size: 225 mm

Delicate Scissors



03-128

03-129

03-128 - 129
 Size: 90 mm



03-130

03-131

03-130 - 131
 Size: 95 mm



03-132

03-133

03-132 - 133
 Size: 105 mm



03-134

03-135

03-134 - 135
 Size: 120 mm



03-136

03-137

03-136 - 137
 Size: 115 mm

Delicate Scissors



03-138 - 140
 Size: 120 mm



03-138

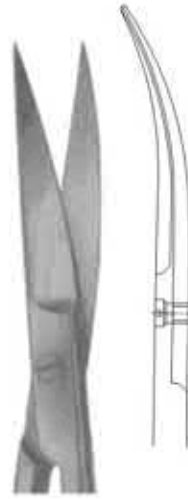

03-139



03-140



03-141 - 144
 Size: 130 mm



03-141



03-142

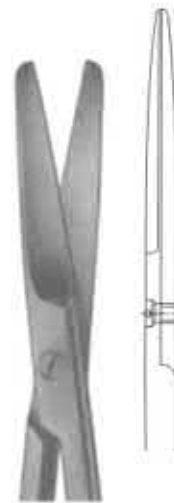

03-143



03-144

Surgical Scissors

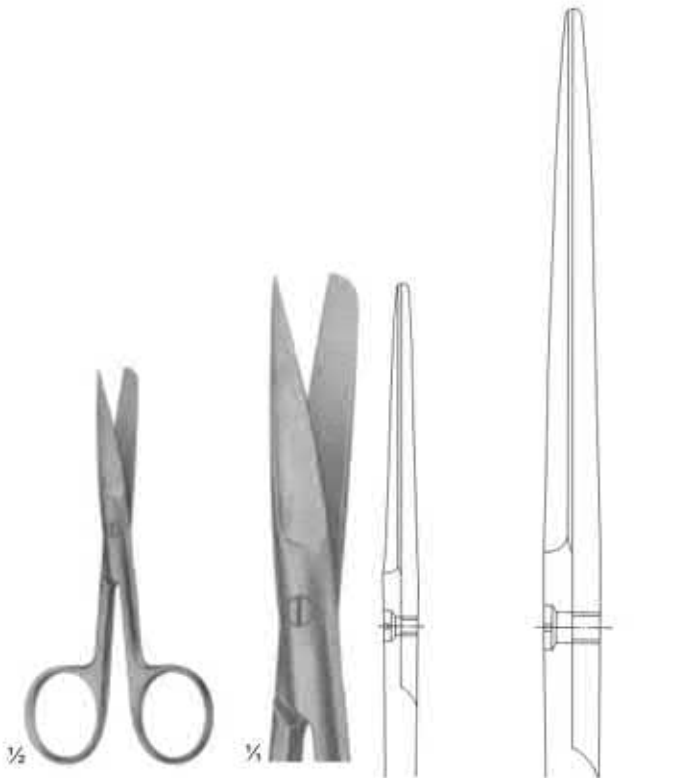

03-145 - 153 (Standard types)
 03-145 (105 mm)
 03-146 (115 mm)
 03-147 (130 mm)
 03-148 (145 mm)
 03-149 (150 mm)
 03-150 (165 mm)
 03-151 (175 mm)
 03-152 (185 mm)
 03-153 (200 mm)

03-145
 Size: 105 mm

03-153
 Size: 200 mm



03-154 - 160 (Standard types)
 03-154 (115 mm)
 03-155 (130 mm)
 03-156 (145 mm)
 03-157 (150 mm)
 03-158 (165 mm)
 03-159 (175 mm)
 03-160 (185 mm)

03-154
 Size: 115 mm

03-160
 Size: 185 mm

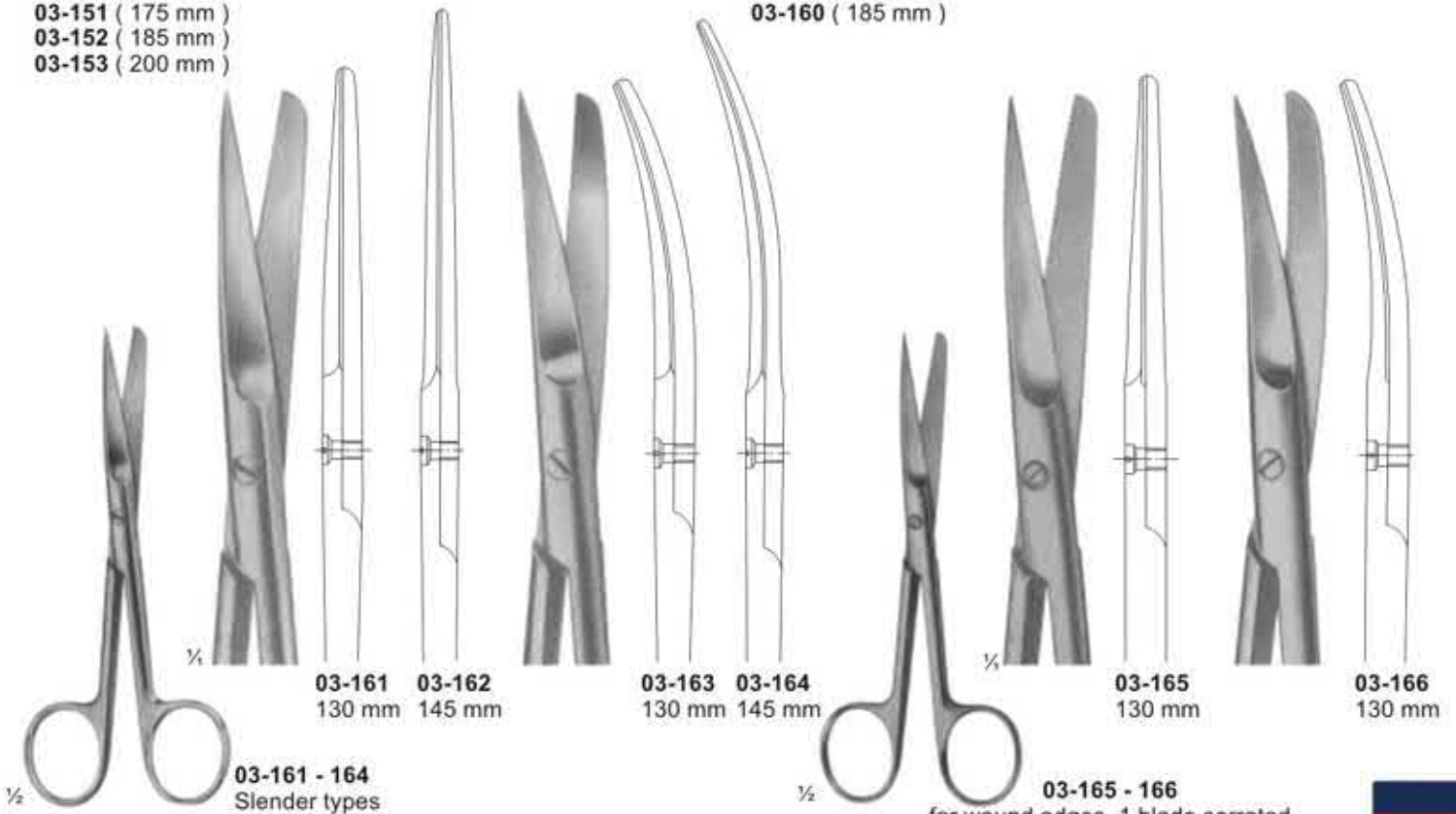

03-161 - 164
 Slender types

03-161 130 mm 03-162 145 mm

03-163 130 mm 03-164 145 mm

03-165 - 166
 for wound edges. 1 blade serrated

03-165 130 mm 03-166 130 mm

Surgical Scissors



03-167 - 169
 DEAVER
 with flat lock

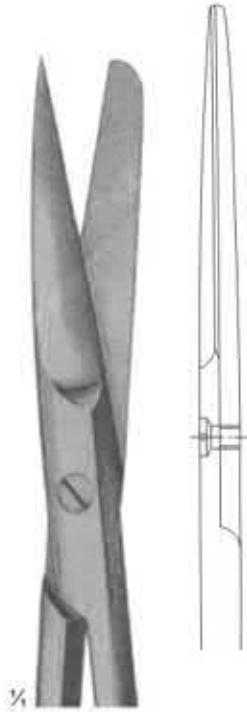

03-167
 Size: 145 mm

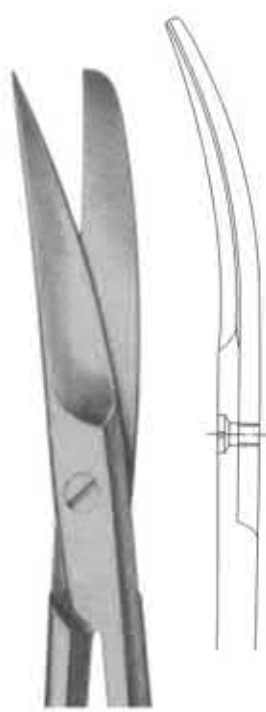

03-168
 Size: 145 mm

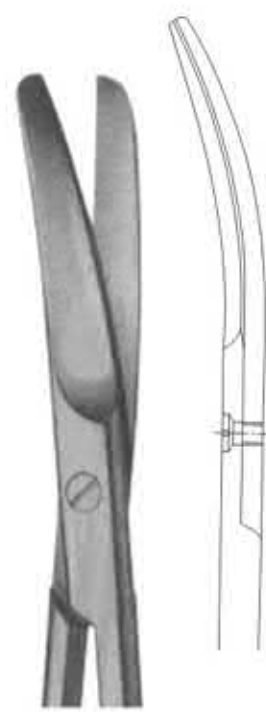

03-169
 Size: 145 mm



03-170 - 172
 Incision scissors



03-170
 Size: 130 mm



03-171
 Size: 145 mm

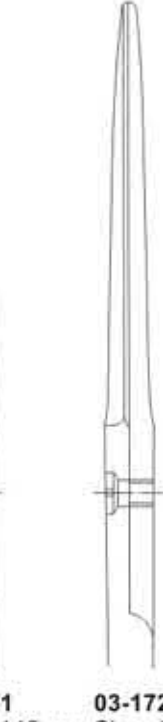

03-172
 Size: 165 mm



03-173
 SYSTRUNK
 Nail splitting scissors



03-173
 Size: 130 mm

Dissecting Scissors

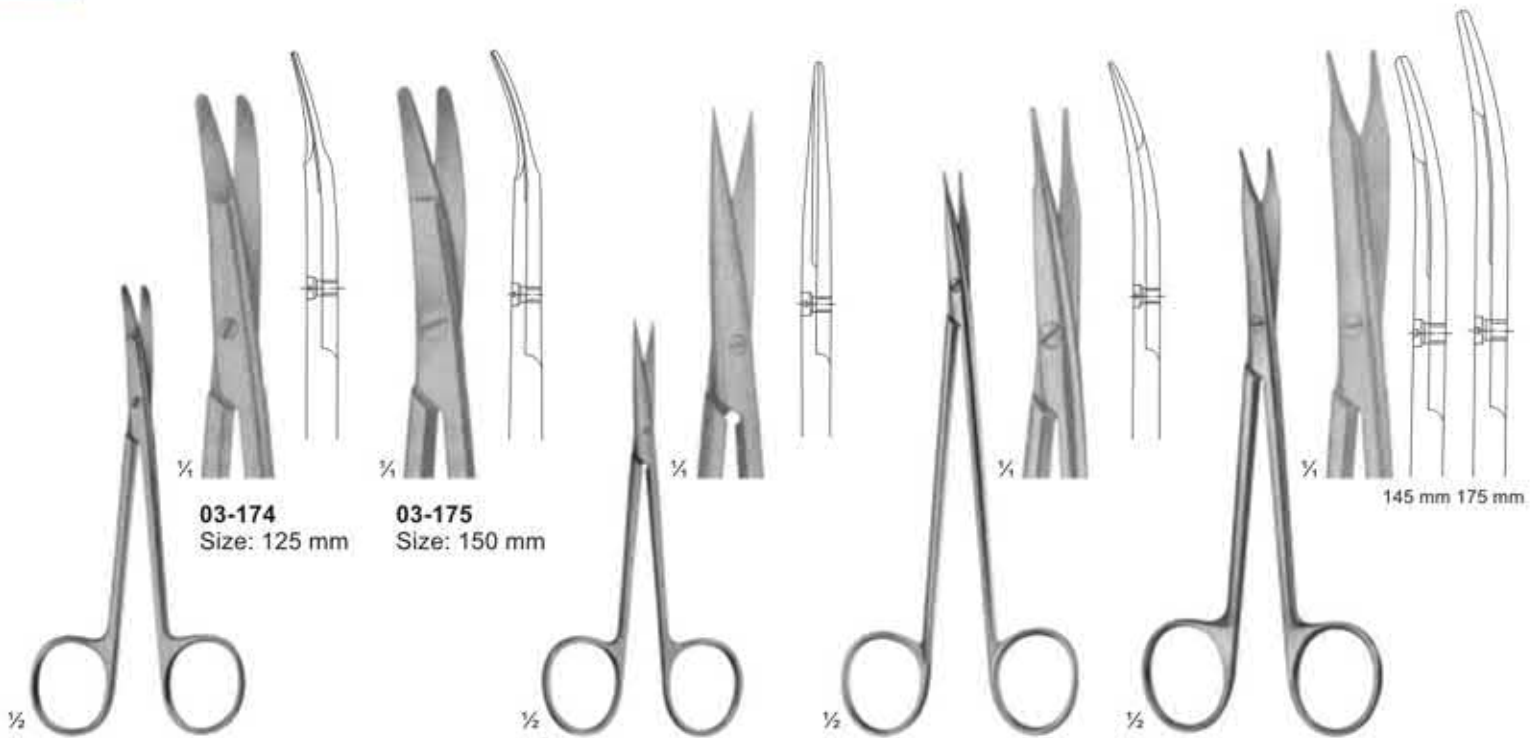

03-174 - 175
KILNER
 Special flat points for dissecting and undermining the skin

03-176
KILNER
 Fine dissecting scissors
 Size: 115 mm

03-177
JAMESON
 Dissecting scissors
 Size: 150 mm

03-178
REYNOLDS
 Dissecting scissors
 Size: 145 - 175 mm

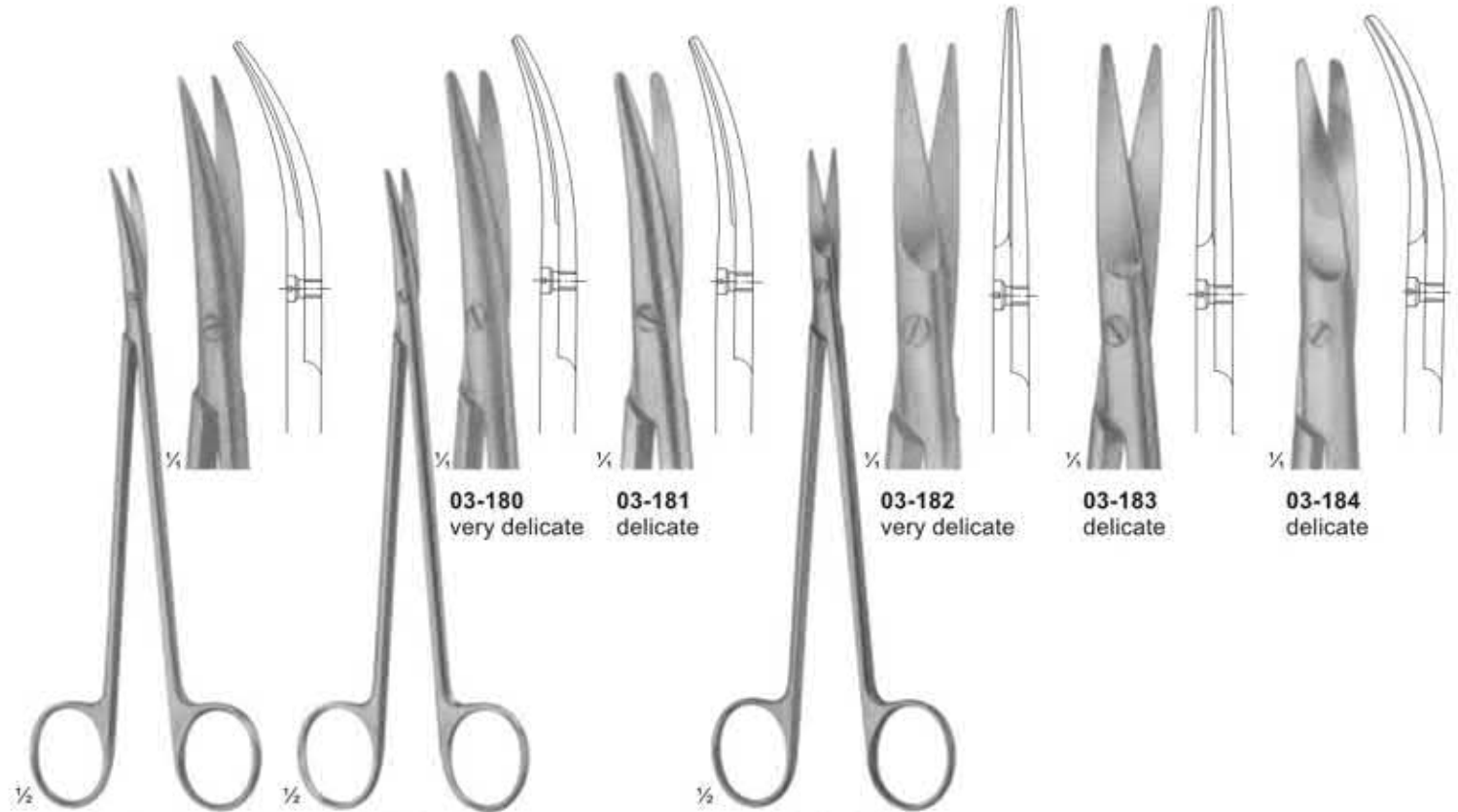

03-179
DE BAKEY
 Arteriotomy scissors
 Size: 175 mm

03-180 - 181
TOENNIS ADSON
 Dissecting scissors
 Size: 175 mm

03-182 - 184
TOENNIS
 Dissecting scissors
 Size: 180 mm

Dissecting Scissors

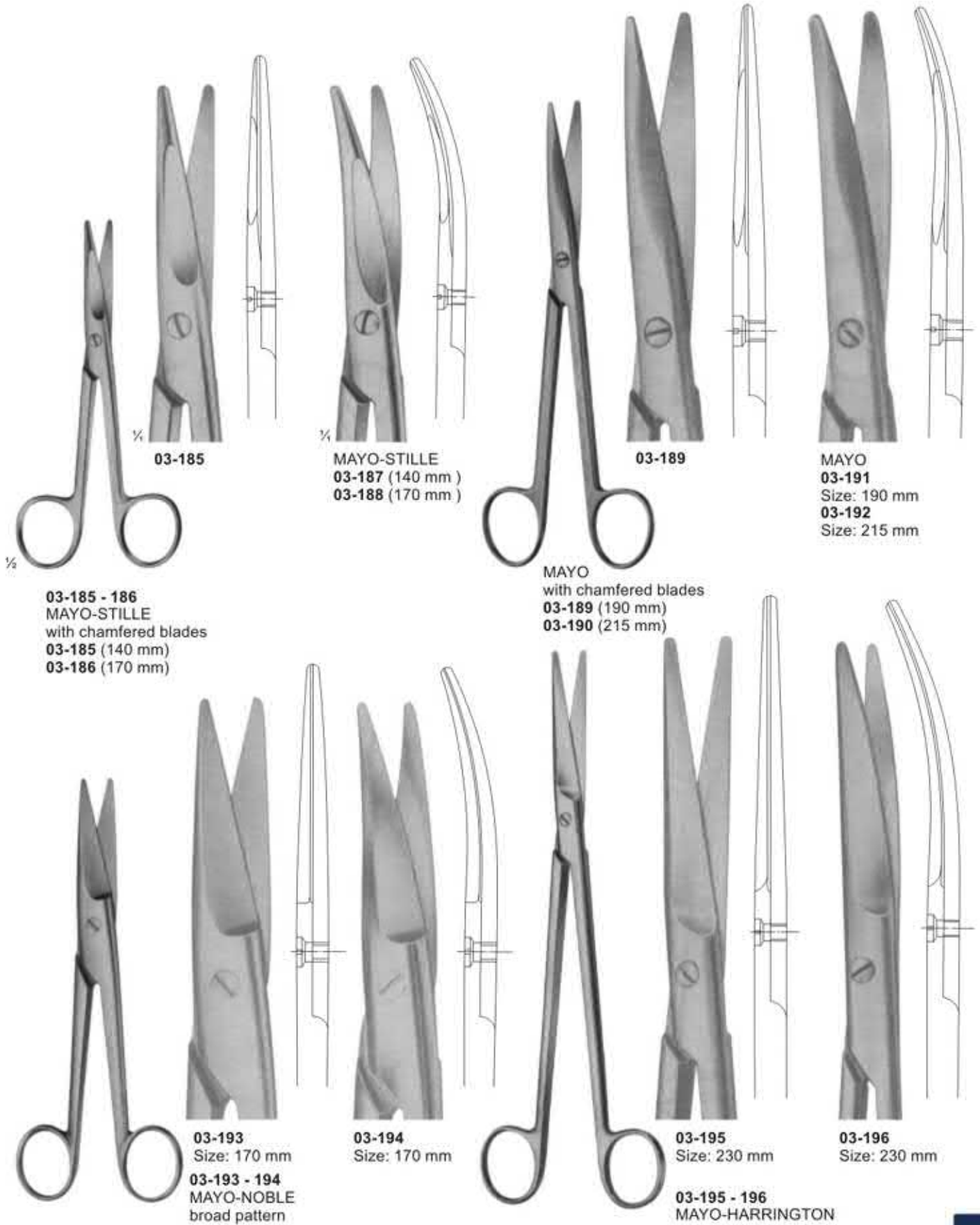

03-185

MAYO-STILLE
03-187 (140 mm)
03-188 (170 mm)

03-189

MAYO
03-191
 Size: 190 mm
03-192
 Size: 215 mm

03-185 - 186
MAYO-STILLE
 with chamfered blades
03-185 (140 mm)
03-186 (170 mm)

MAYO
 with chamfered blades
03-189 (190 mm)
03-190 (215 mm)

03-193
 Size: 170 mm

03-194
 Size: 170 mm

03-195
 Size: 230 mm

03-196
 Size: 230 mm

03-193 - 194
MAYO-NOBLE
 broad pattern

03-195 - 196
MAYO-HARRINGTON

Scissors for Cardiovascular and Neuro-Surgery



03-197
OLIVECRONA
 Dura scissors



03-198
STRULLY
 pointed
 Size: 220 mm

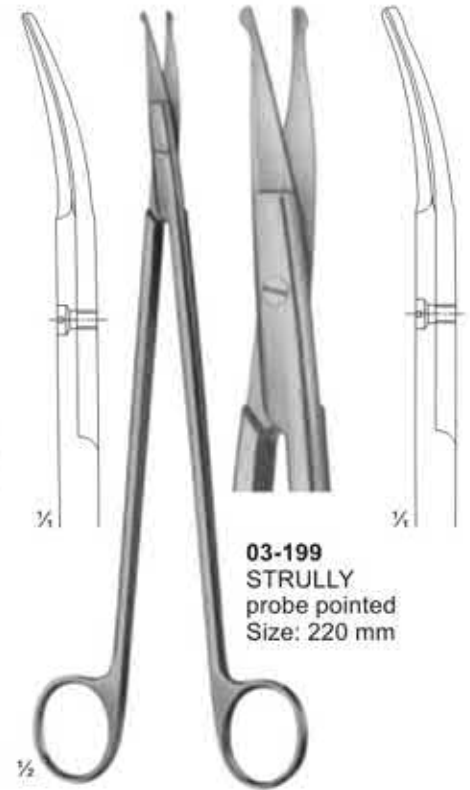

03-199
STRULLY
 probe pointed
 Size: 220 mm

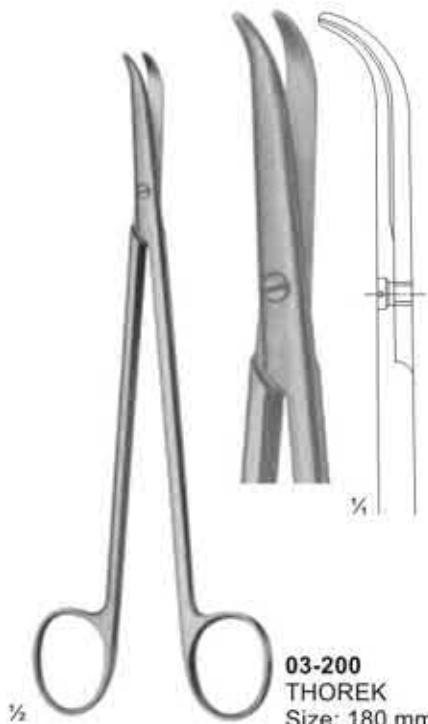

03-200
THOREK
 Size: 180 mm

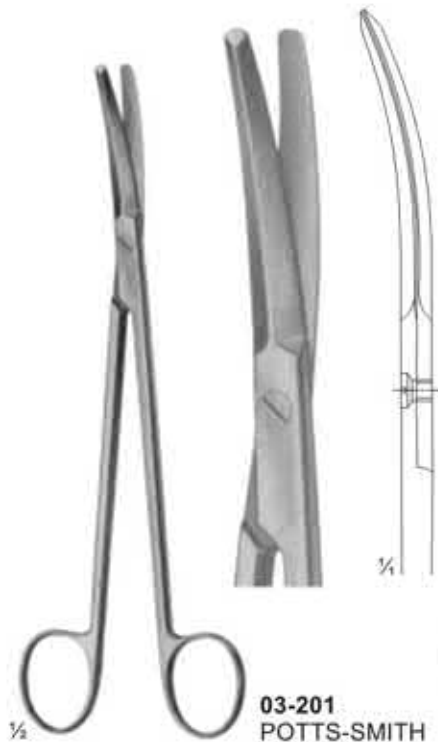

03-201
POTTS-SMITH
 Size: 190 mm

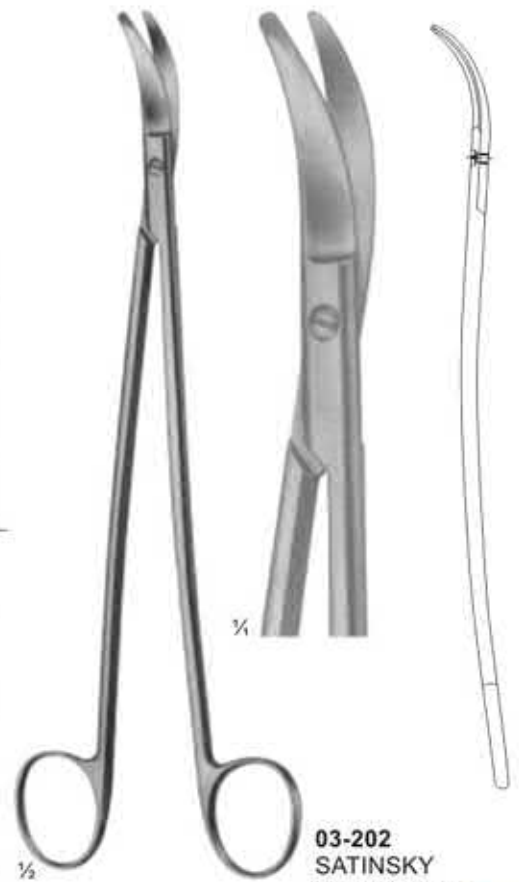

03-202
SATINSKY
 Size: 245 mm

Delicate, Nasal and Tonsil Scissors

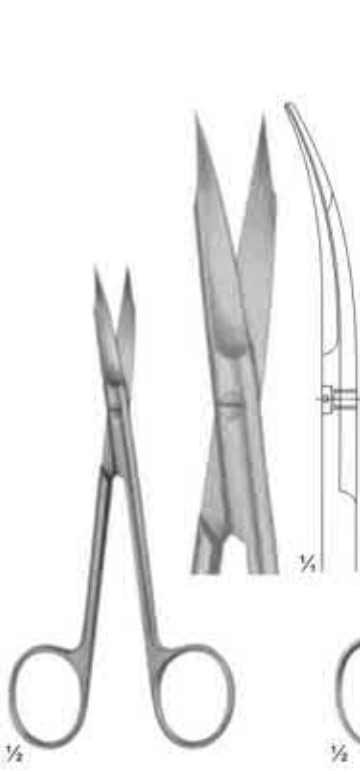

03-203
 1 finely toothed blade
 Size: 130 mm

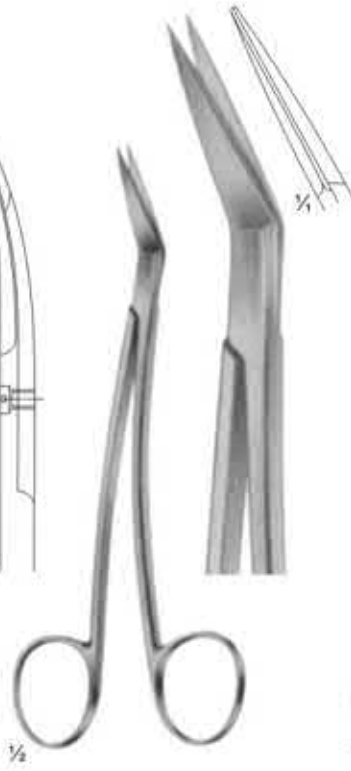

03-204
 LOCKLIN
 curved sideways,
 1 toothed blade
 Size: 155 mm

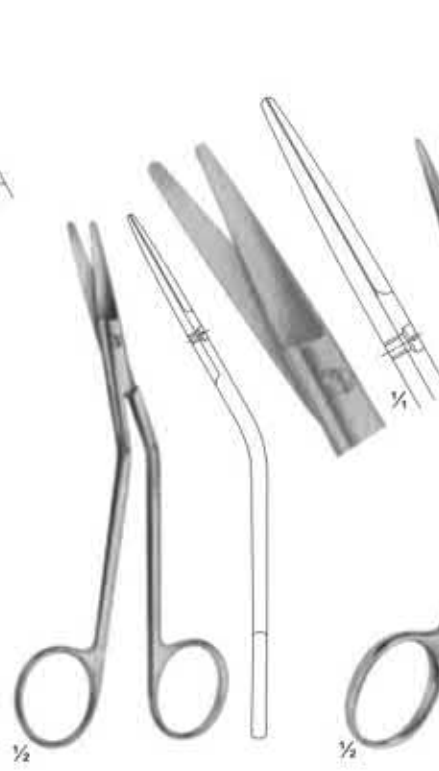

03-205
 FOMON
 blades serrated
 Size: 145 mm

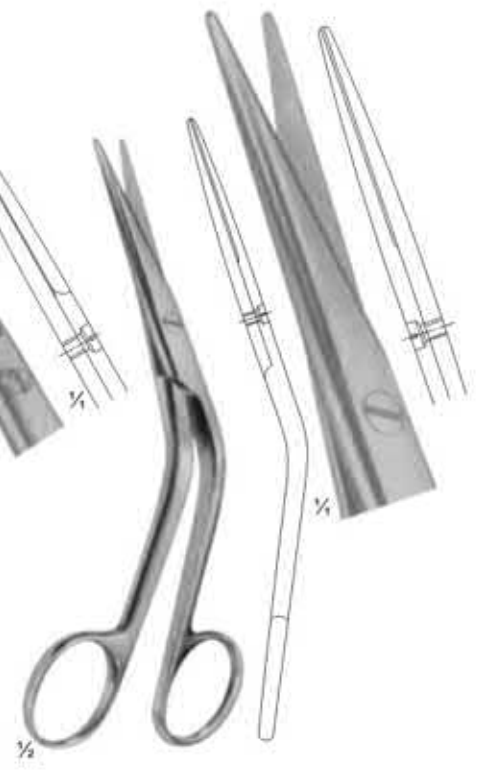

03-206
 COTTLE
 Size: 165 mm



03-207
 HEYMAN-KNIGHT
 Size: 175 mm

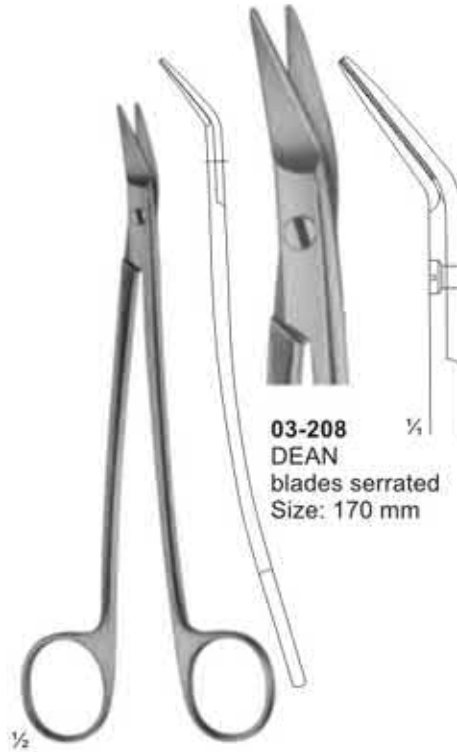

03-208
 DEAN
 blades serrated
 Size: 170 mm

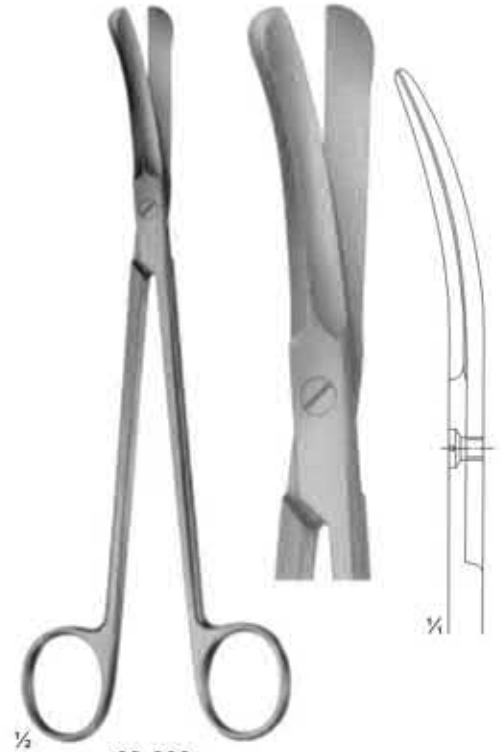

03-209
 GOOD
 Size: 195 mm

Bone Shears

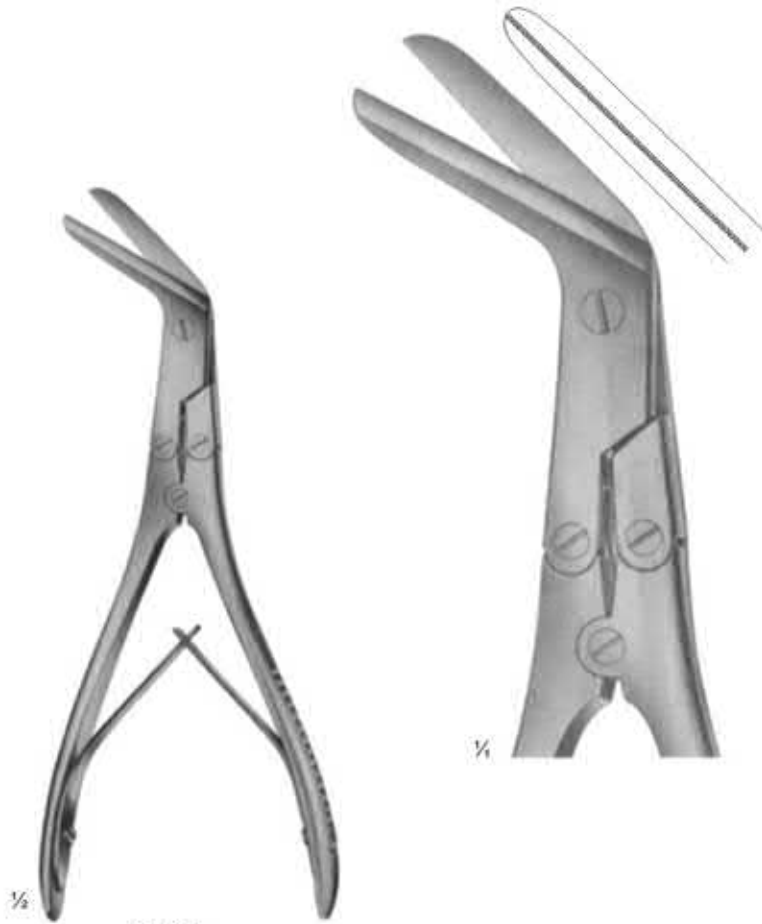

03-210
KILLIAN
 Size: 200 mm



03-211 - 03-212



03-211
 195 mm



03-212
 225 mm



**Scissors for deep operations and
 for Gynaecology**

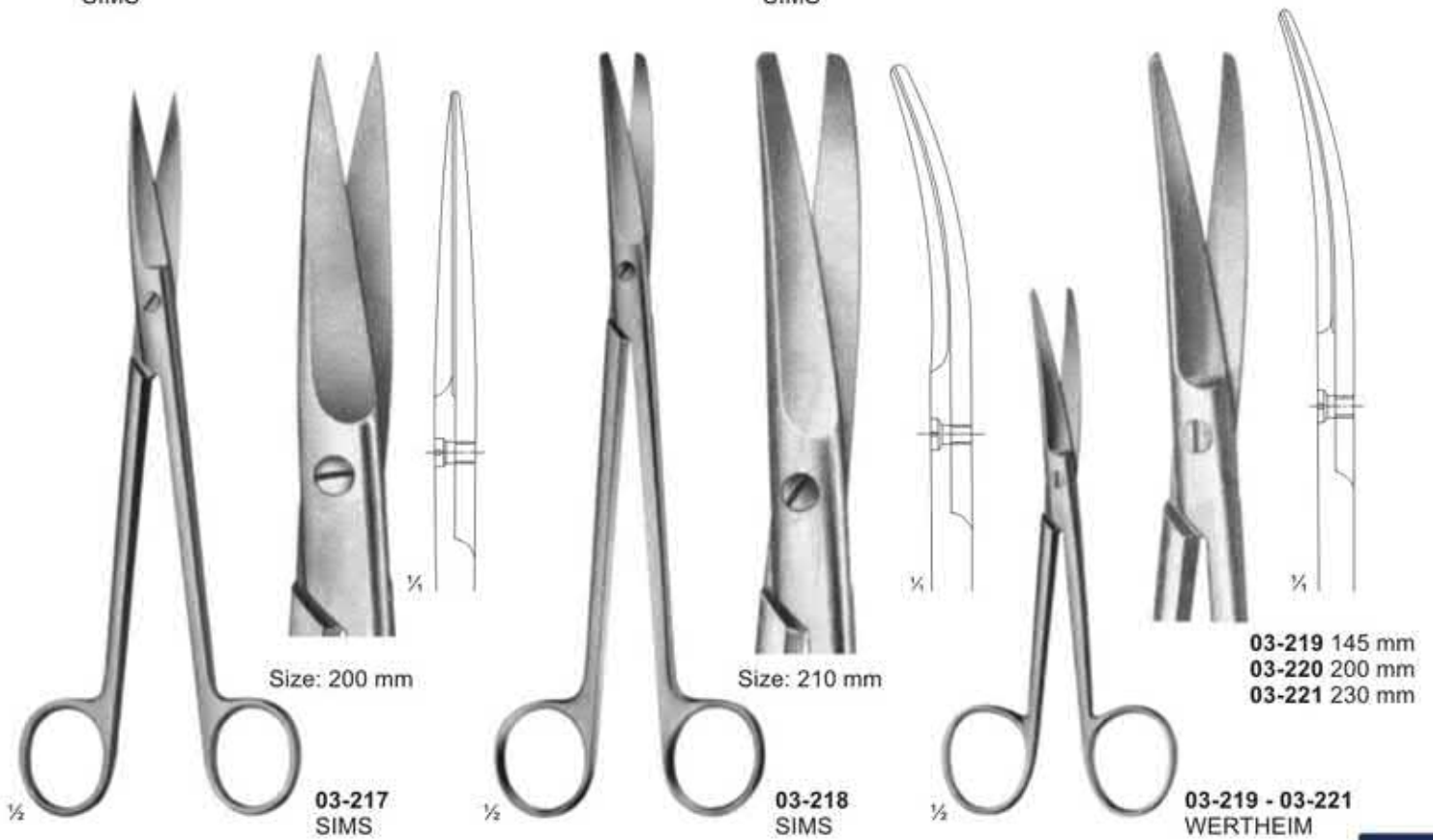
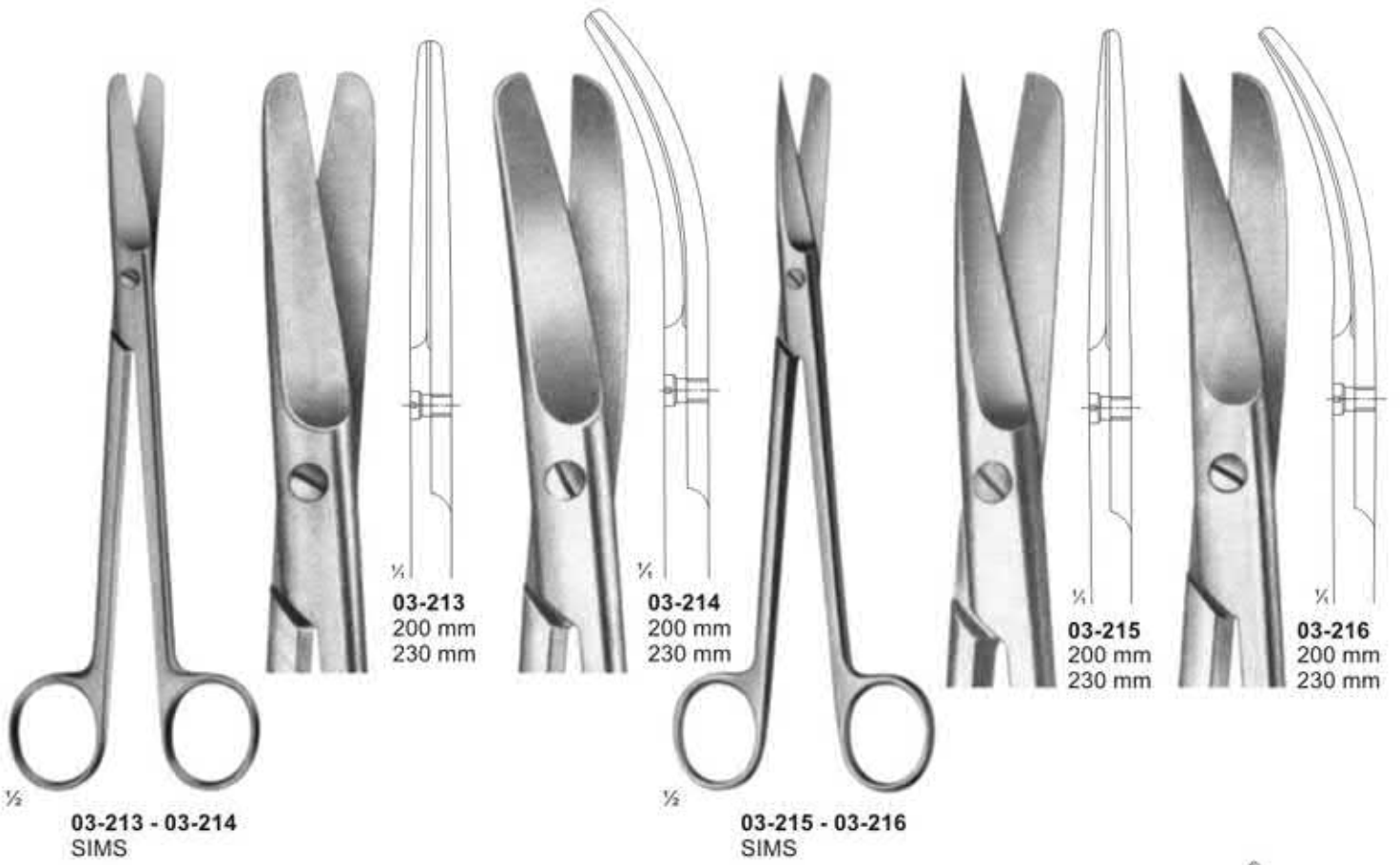

Scissors for Obstetrics



03-222
SCHUMACHER
 Umbilical cord scissors
 Size: 155 mm



03-223
 Umbilical cord scissors
 Size: 105 mm

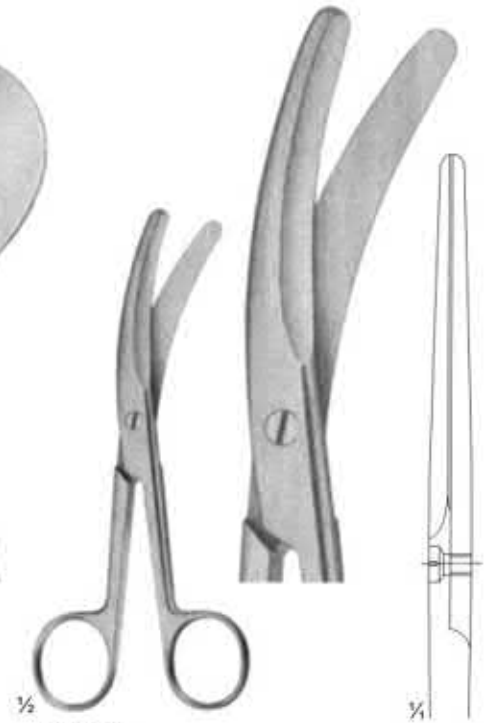

03-224
 Umbilical cord scissors

135 mm



03-225
 145 mm

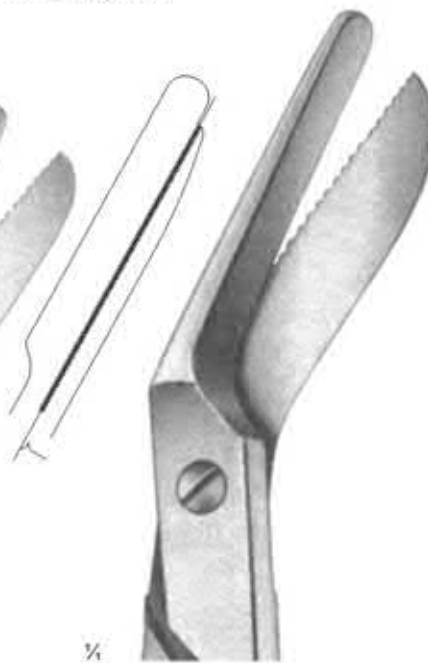

03-226
 200 mm

03-225 - 03-226
BRAUN-STADLER
 Episiotomy scissors

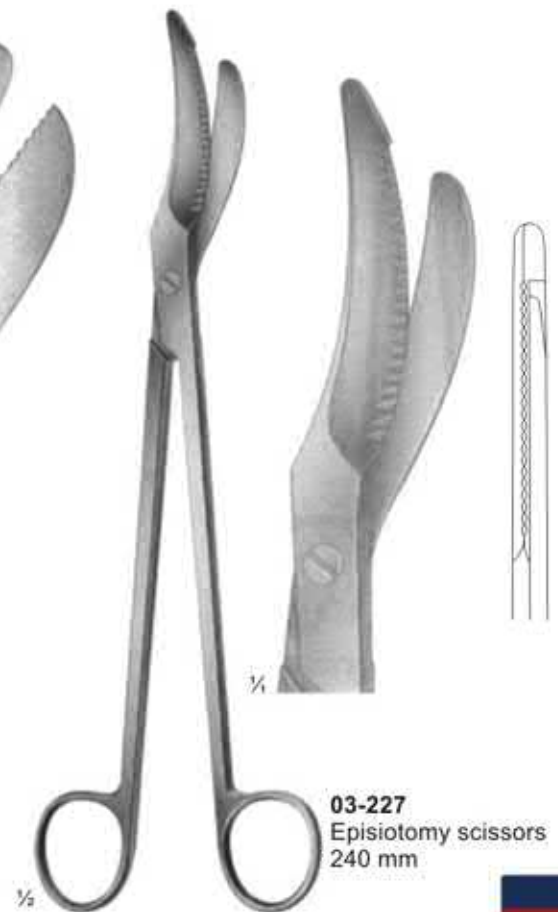

03-227
 Episiotomy scissors
 240 mm

Wire and Plate Scissors

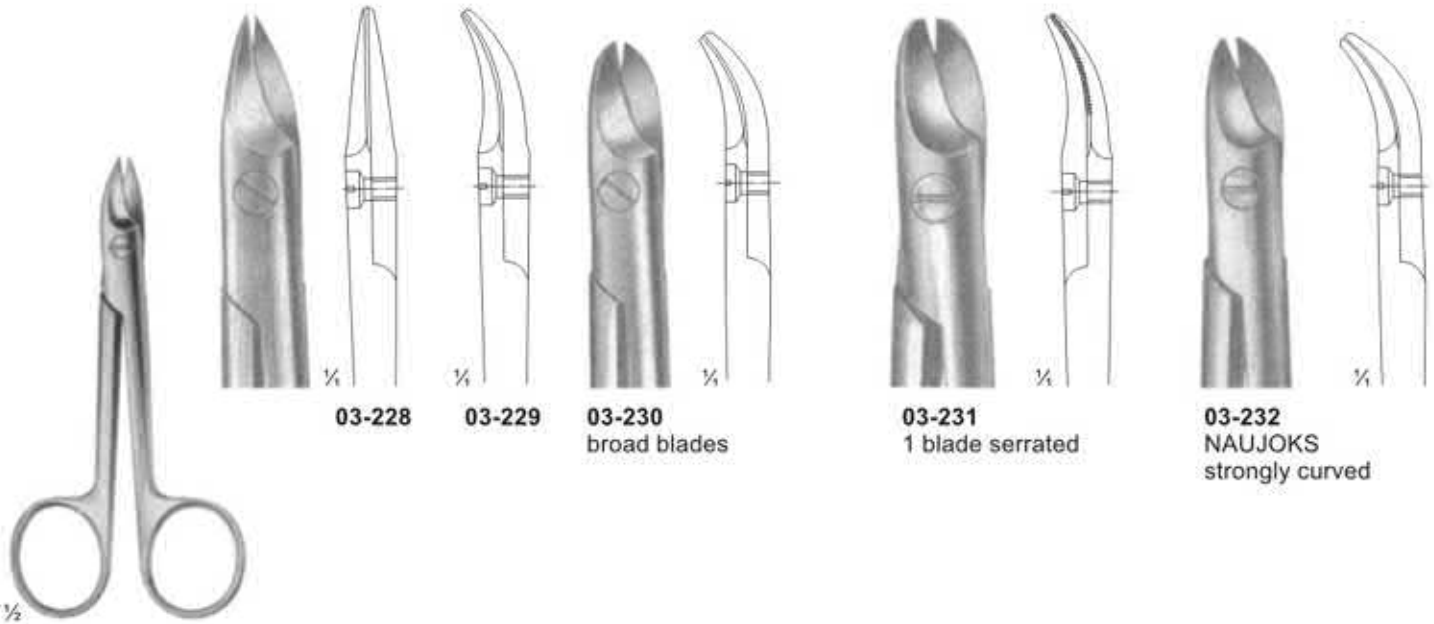

03-228

03-229

03-230
broad blades

03-231
1 blade serrated

03-232
NAUJOKS
strongly curved

03-228 - 03-232
BEEBE
Size: 110 mm

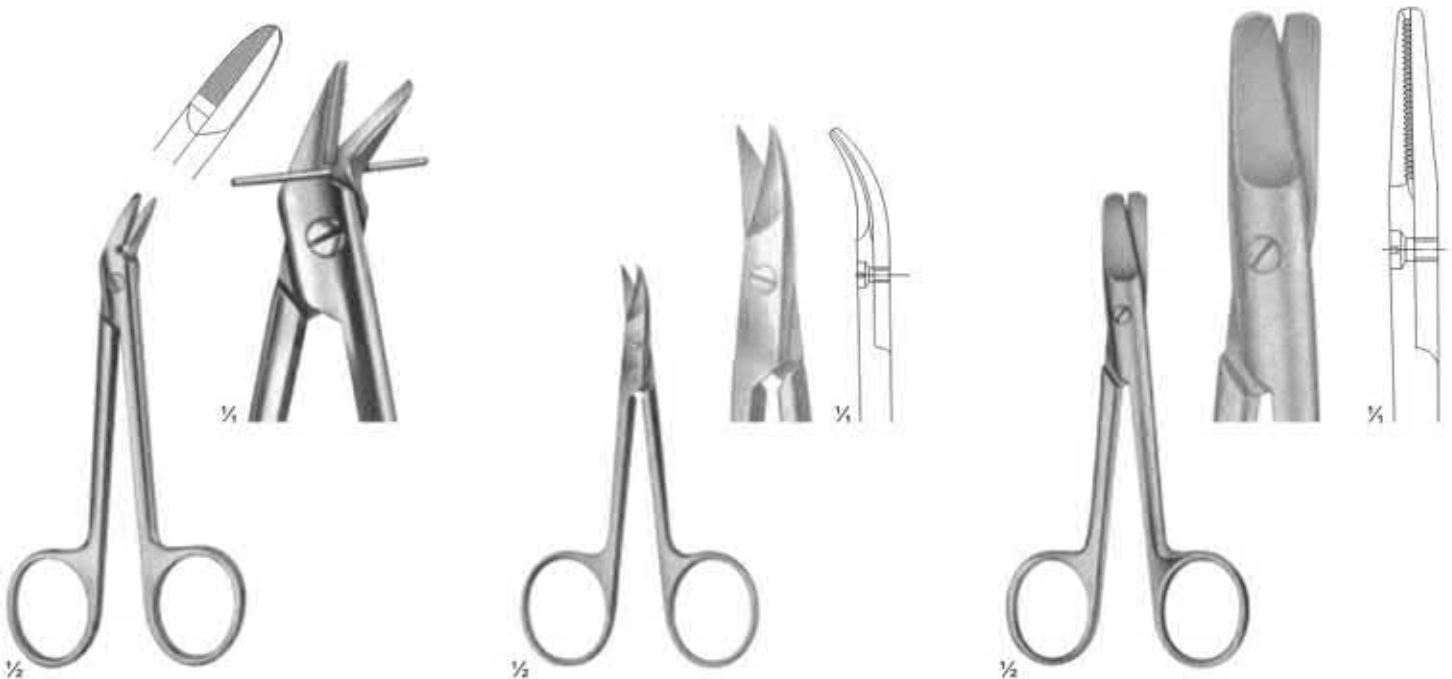

03-233
1 blade serrated
Size: 120 mm

03-234
STRACK
Size: 100 mm

03-235
HARVEY
blades serrated
Size: 125 mm

Bandage and Cloth Scissors



03-236
 Universal bandage and cloth scissors,
 with toothed edges
 180 mm



03-237
 LISTER
 Universal bandage and cloth scissors,
 with toothed edges
 Size: 145 mm

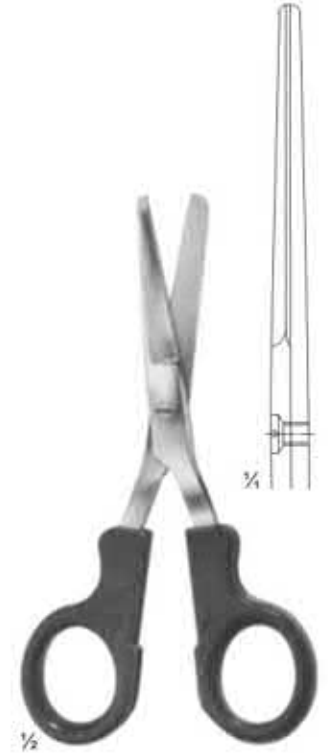

03-238
 LISTER
 Nurse's scissors
 Size: 145 mm

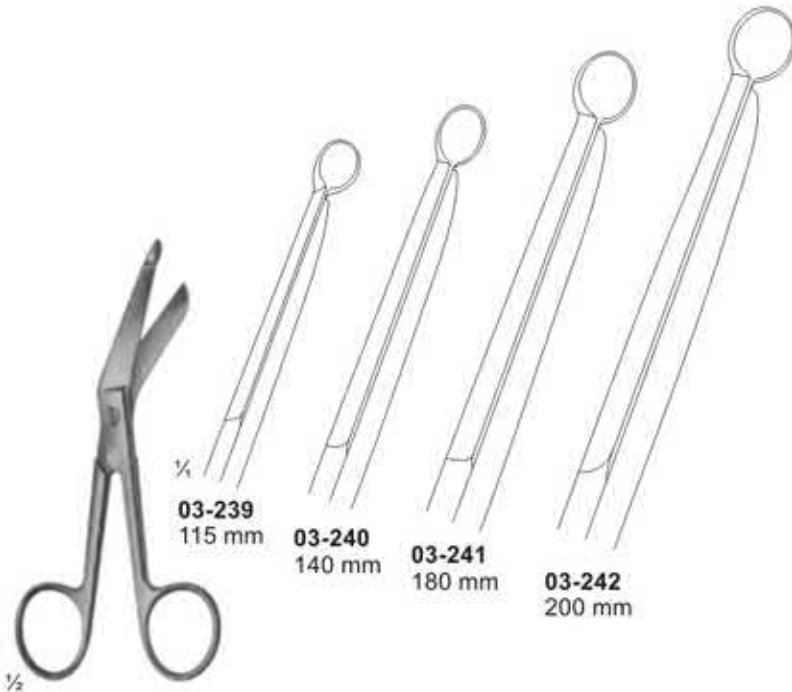

03-239 - 03-242
 LISTER

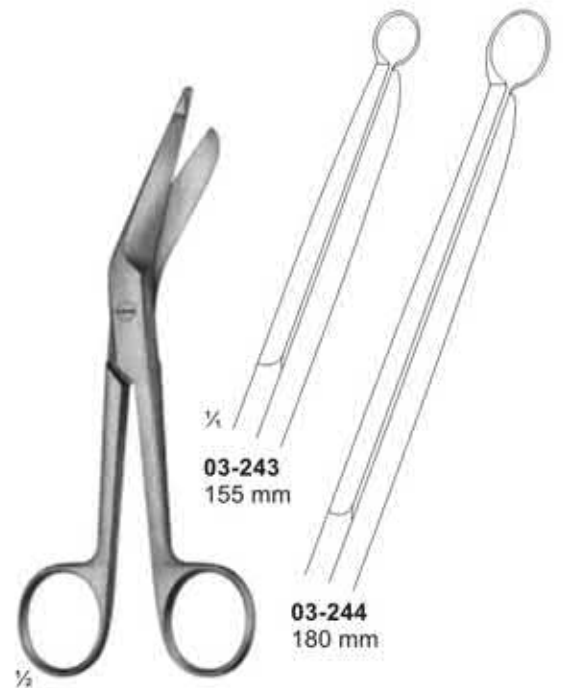

03-243 - 03-244
 LISTER

Bandage-, Cloth-, and Plaster Scissors

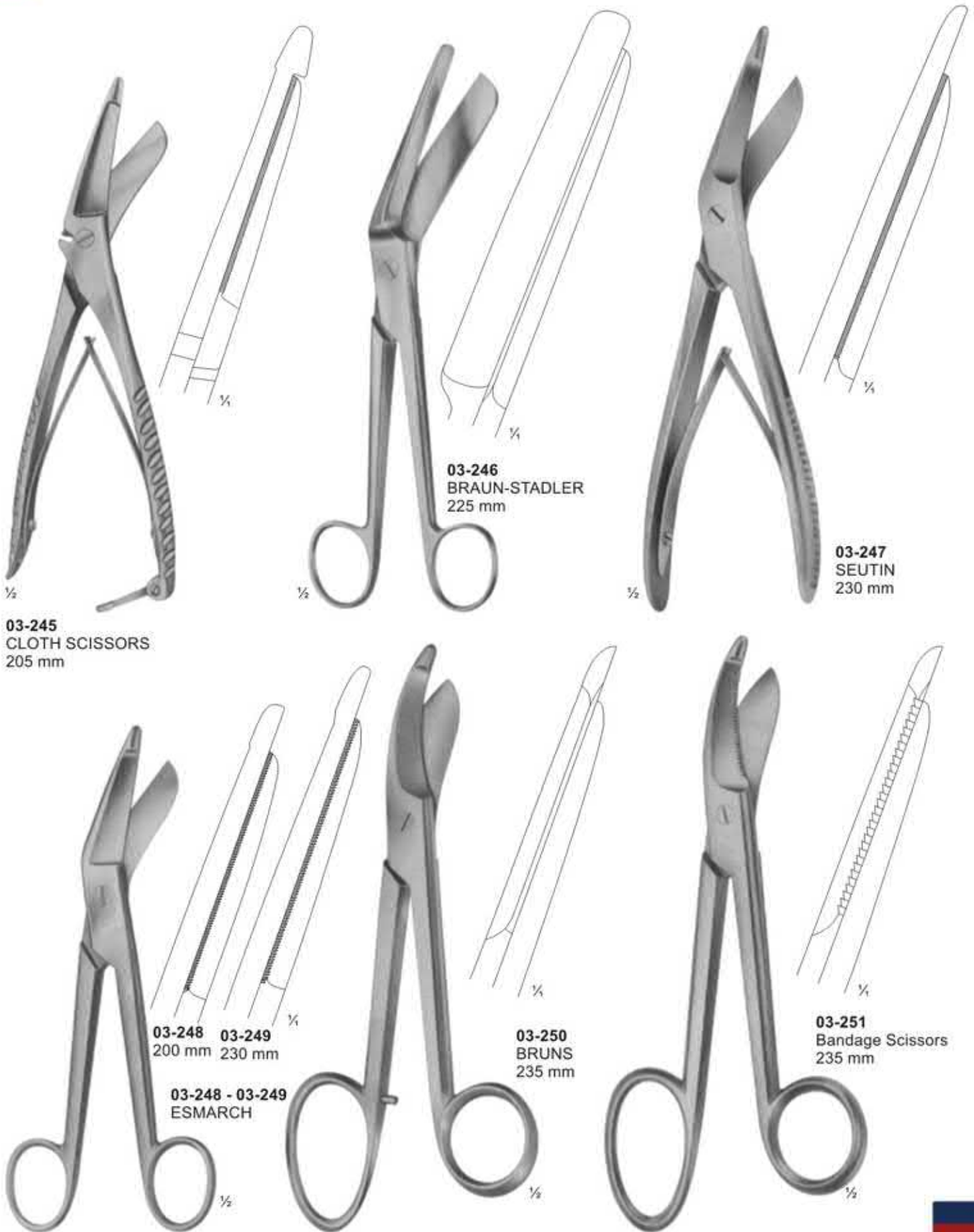

03-245
 CLOTH SCISSORS
 205 mm

03-246
 BRAUN-STADLER
 225 mm

03-247
 SEUTIN
 230 mm

03-248 200 mm
03-249 230 mm

03-248 - 03-249
 ESMARCH

03-250
 BRUNS
 235 mm

03-251
 Bandage Scissors
 235 mm

Forceps for grasping tissue, tumors etc.

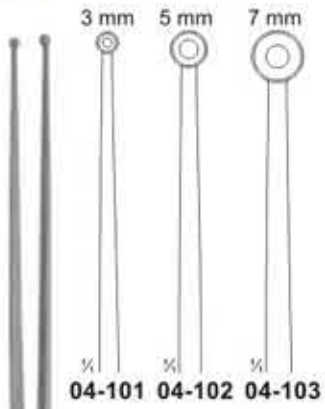

04-101 04-102 04-103

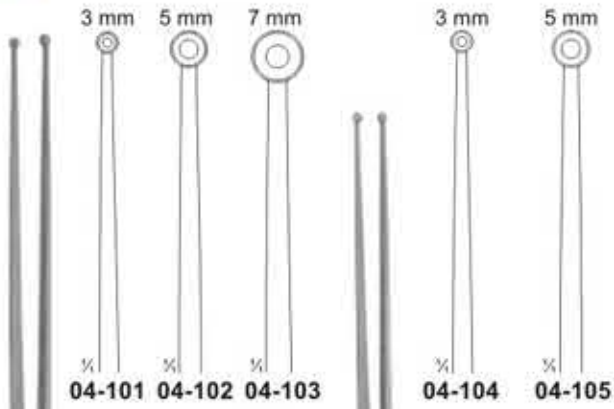

04-104 04-105

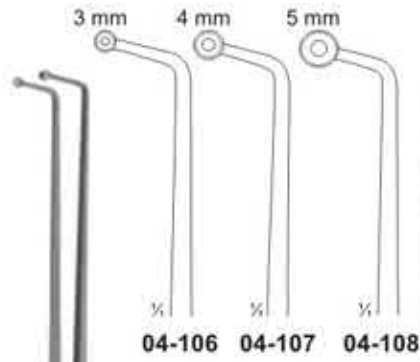

04-106 04-107 04-108

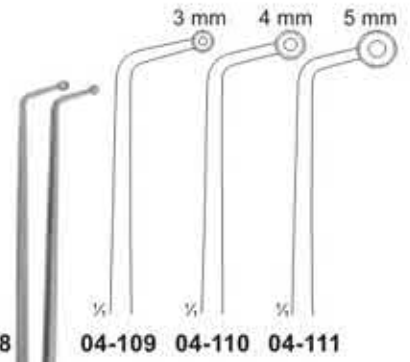

04-109 04-110 04-111



1/2



1/2



1/2



1/2

04-109 - 111
 SAMII
 Jaws spoon-shaped
 230 mm

04-101 - 103
 YASARGIL-SAMII
 Jaws spoon-shaped
 240 mm

04-104 - 105
 YASARGIL
 Jaws spoon-shaped
 220 mm

04-106 - 108
 SAMII
 Jaws spoon-shaped
 230 mm

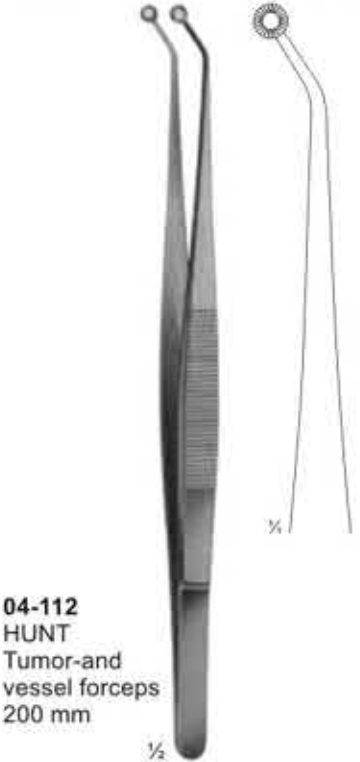

1/2

04-112
 HUNT
 Tumor-and
 vessel forceps
 200 mm



1/2

04-113
 HUNT
 Tumor-and
 vessel forceps
 200 mm



1/2

04-114
 YASARGIL
 Tumor-and
 vessel forceps
 200 mm

**Delicate Dissecting, Microscopic,
 Sterilizing Forceps**



04-115
THORPE
 Corneal forceps
 120 mm



04-116
MICRO-ADSON
 120 mm

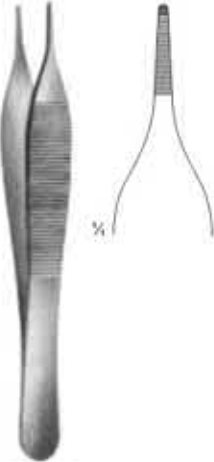

04-117
ADSON
 120 mm



04-118
MICRO-ADSON
 150 mm



04-119 - 121
 100 mm



04-119



04-120



04-121

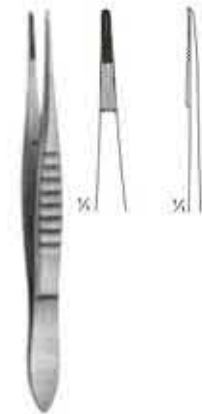

04-122
BONACCOLTO
 110 mm



04-123
 115 mm



04-124 - 133

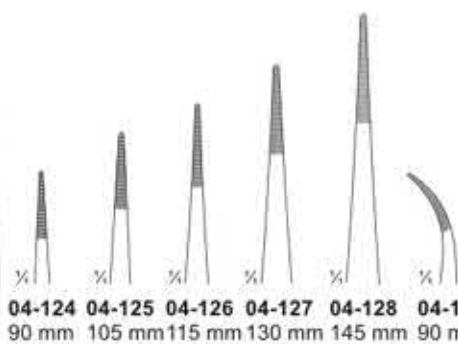

04-124 90 mm **04-125** 105 mm **04-126** 115 mm **04-127** 130 mm **04-128** 145 mm **04-129** 90 mm

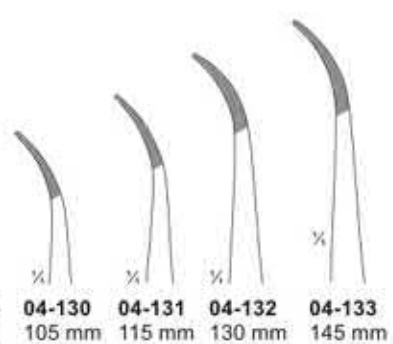

04-130 105 mm **04-131** 115 mm **04-132** 130 mm **04-133** 145 mm



04-134
 100 mm



04-135
 100 mm



04-136
 100 mm



04-137
KUHNE
 Cover glass forceps, 105 mm



04-138
 160 mm

Delicate Dissecting Forceps

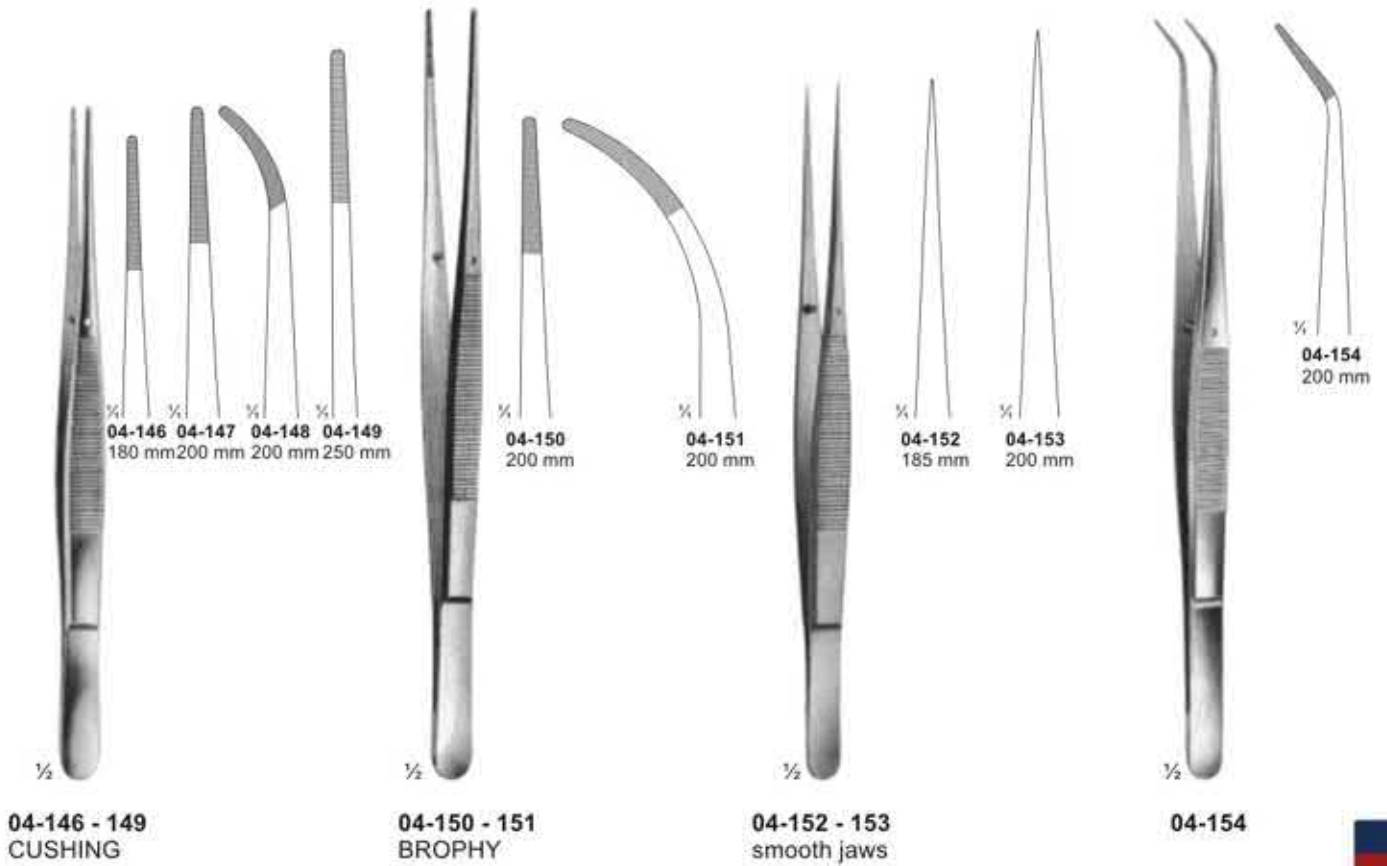
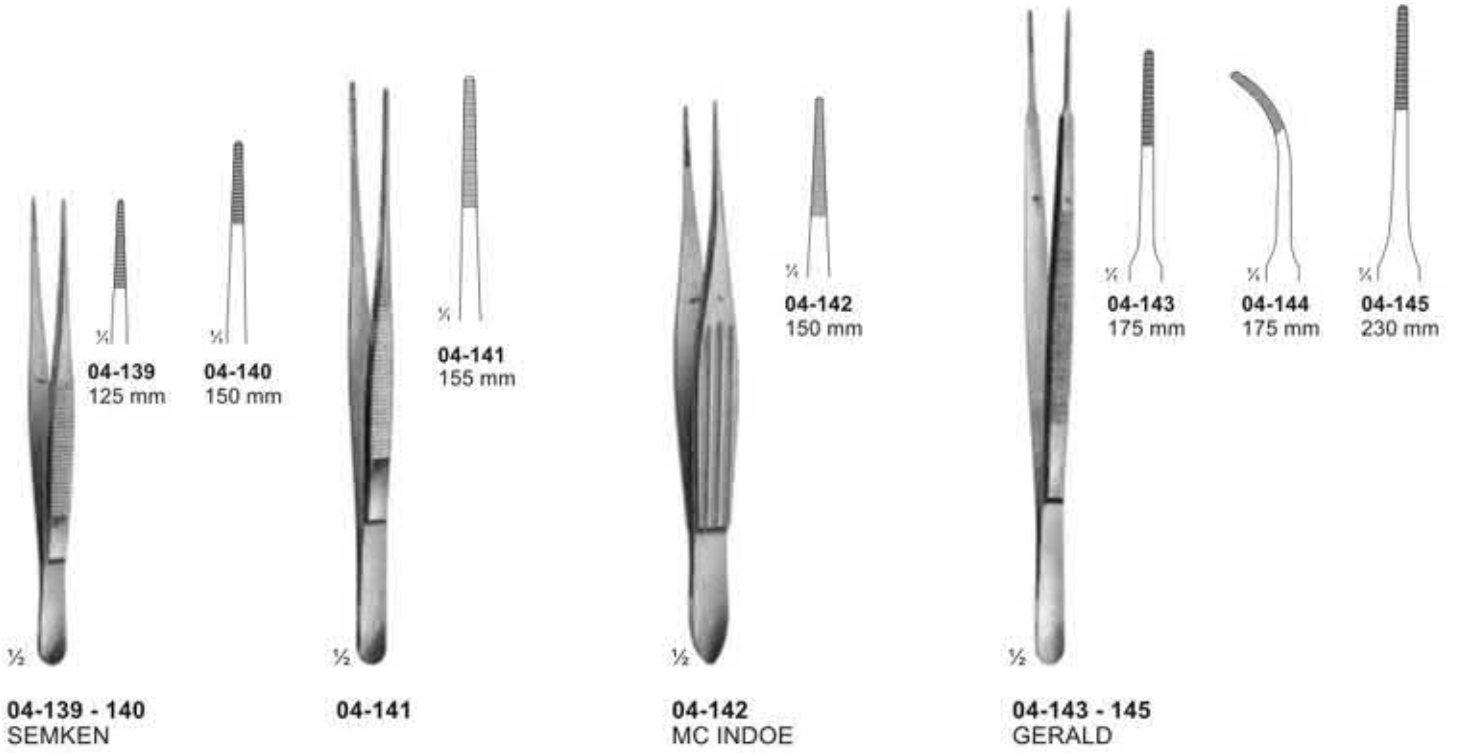

Dissecting Forceps

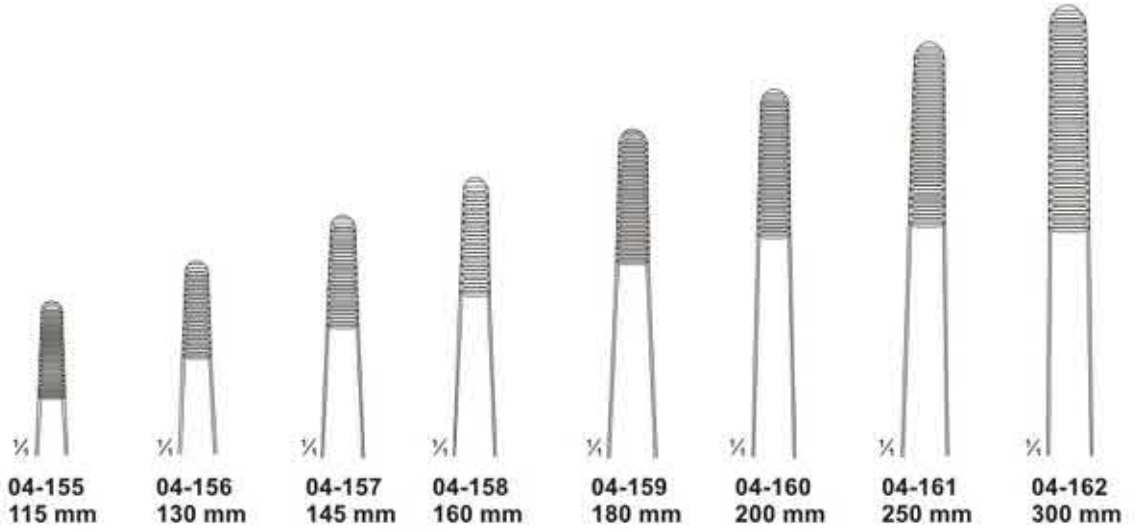

04-155 - 04-162
STANDARD

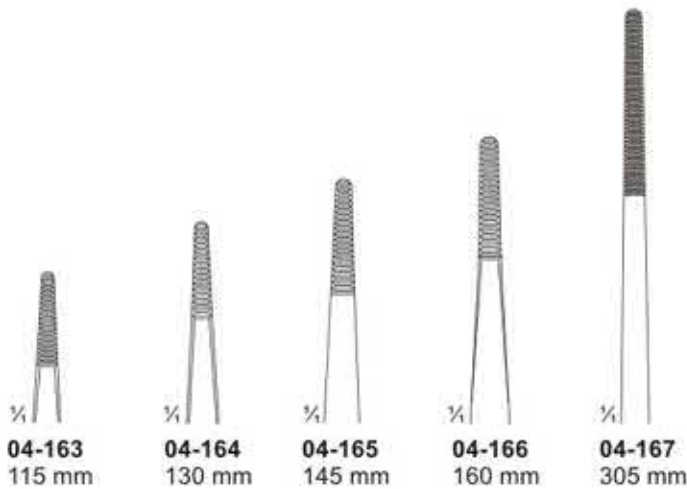

04-163 - 04-167
MEDIUM

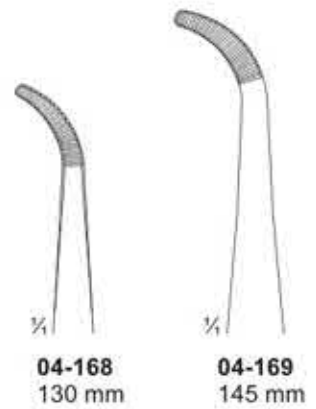

04-168 - 04-169
MEDIUM

Forceps

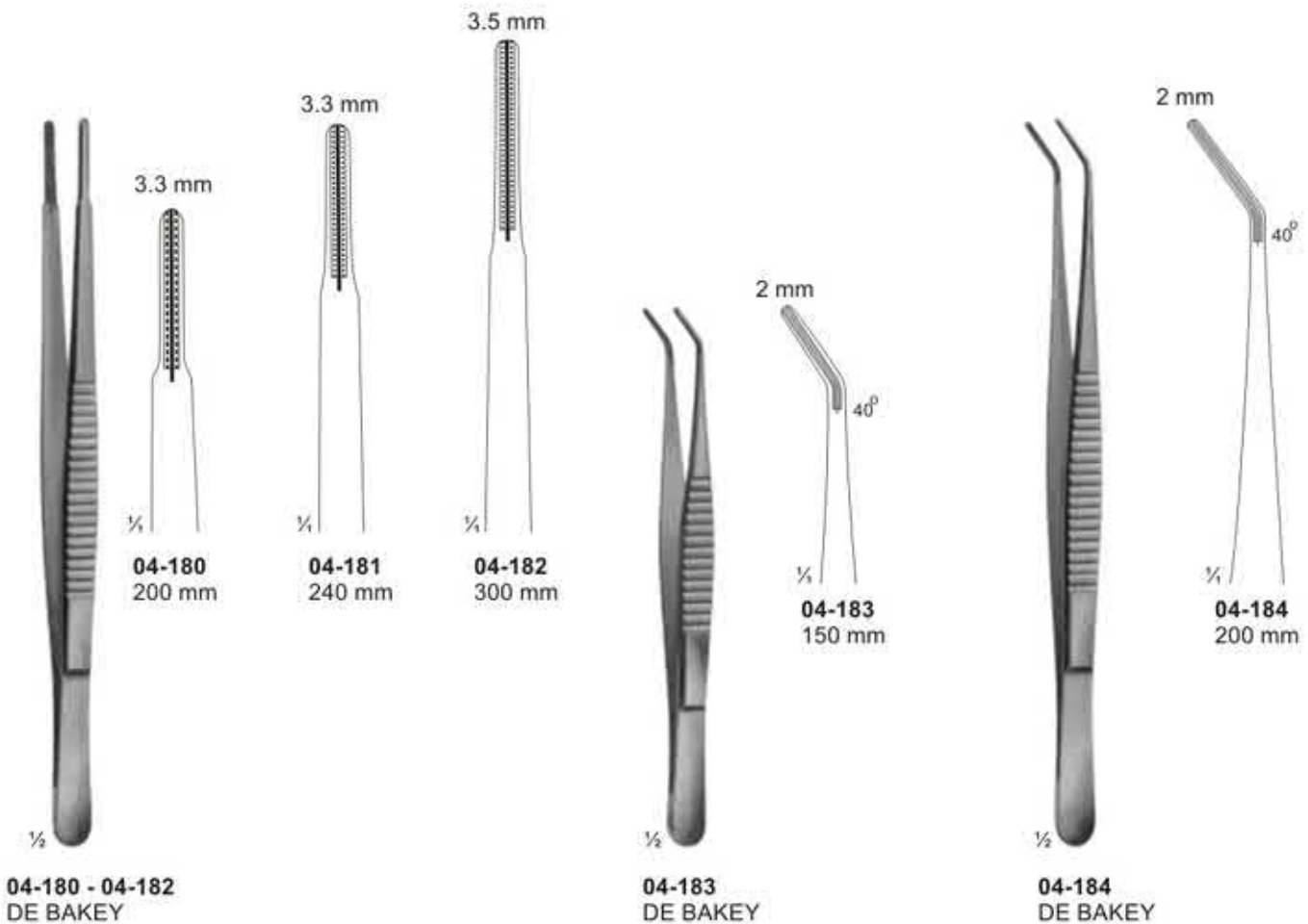
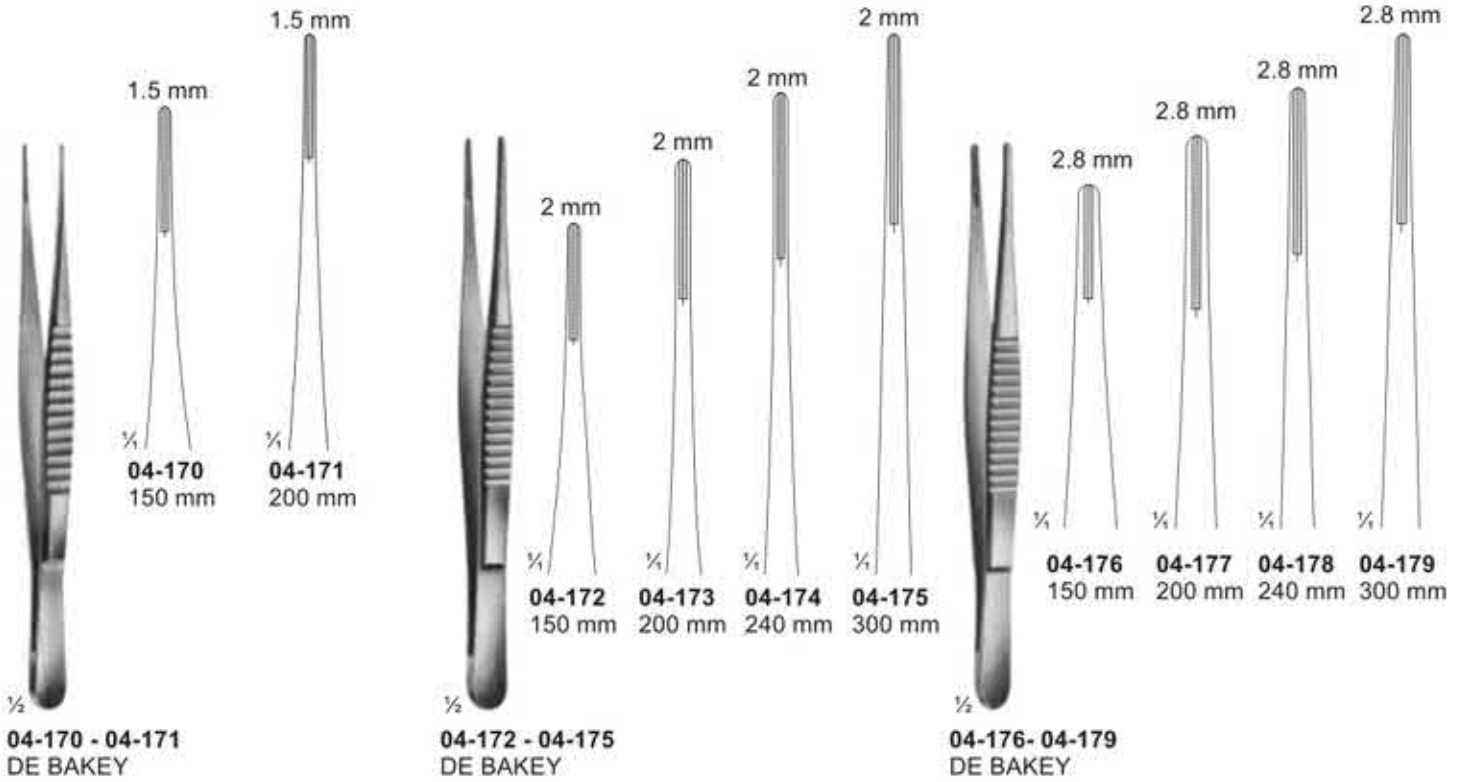

Delicate Tissue Forceps

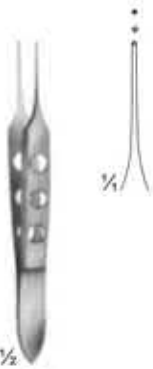

04-185
BISHOP-HARMON
85 mm

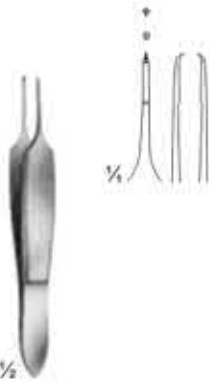

04-186
ST.MARTIN
80 mm

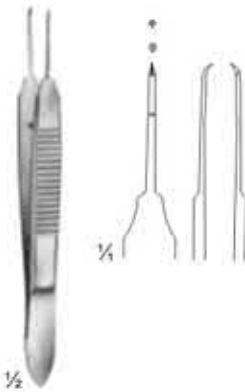

04-187
CASTROVIEJO
teeth 0.9 mm
100 mm

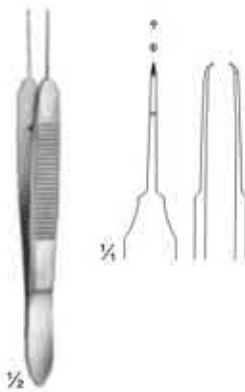

04-188
CASTROVIEJO
teeth 0.5 mm
100 mm

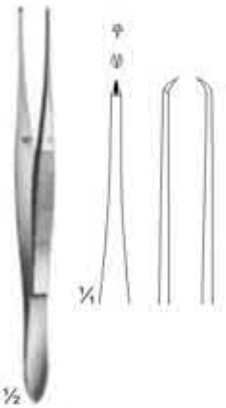

04-189
ELSCHING
110 mm



04-190
GILL
75 mm



04-191
GILL - HESS
75 mm

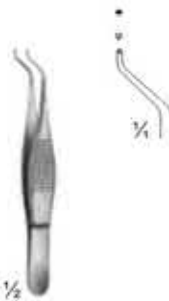

04-192
HESS
70 mm

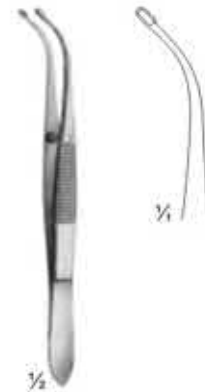

04-193
ARRUGA
100 mm

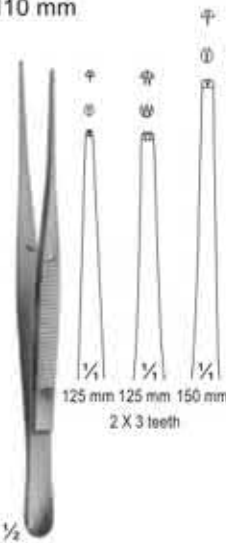

04-194
SEMKEN
125 mm 125 mm 150 mm
2 X 3 teeth

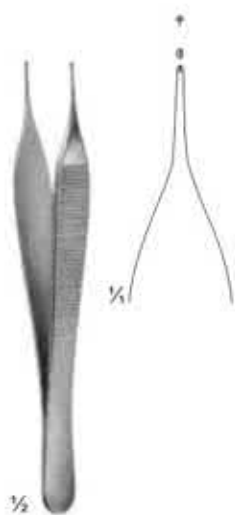

04-195
MICRO-ADSON
120 mm

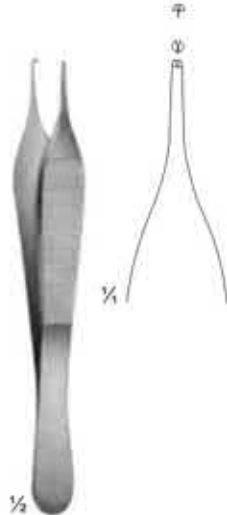

04-196
ADSON
120 mm



04-197
ADSON
120 mm



04-198
ADSON
120 mm

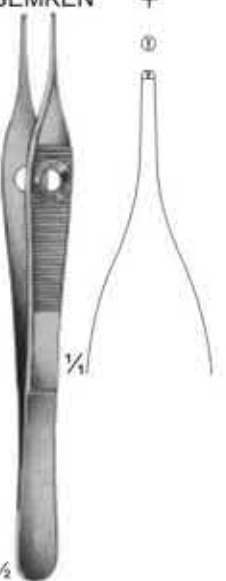

04-199
ADSON
150 mm

Tissue Forceps

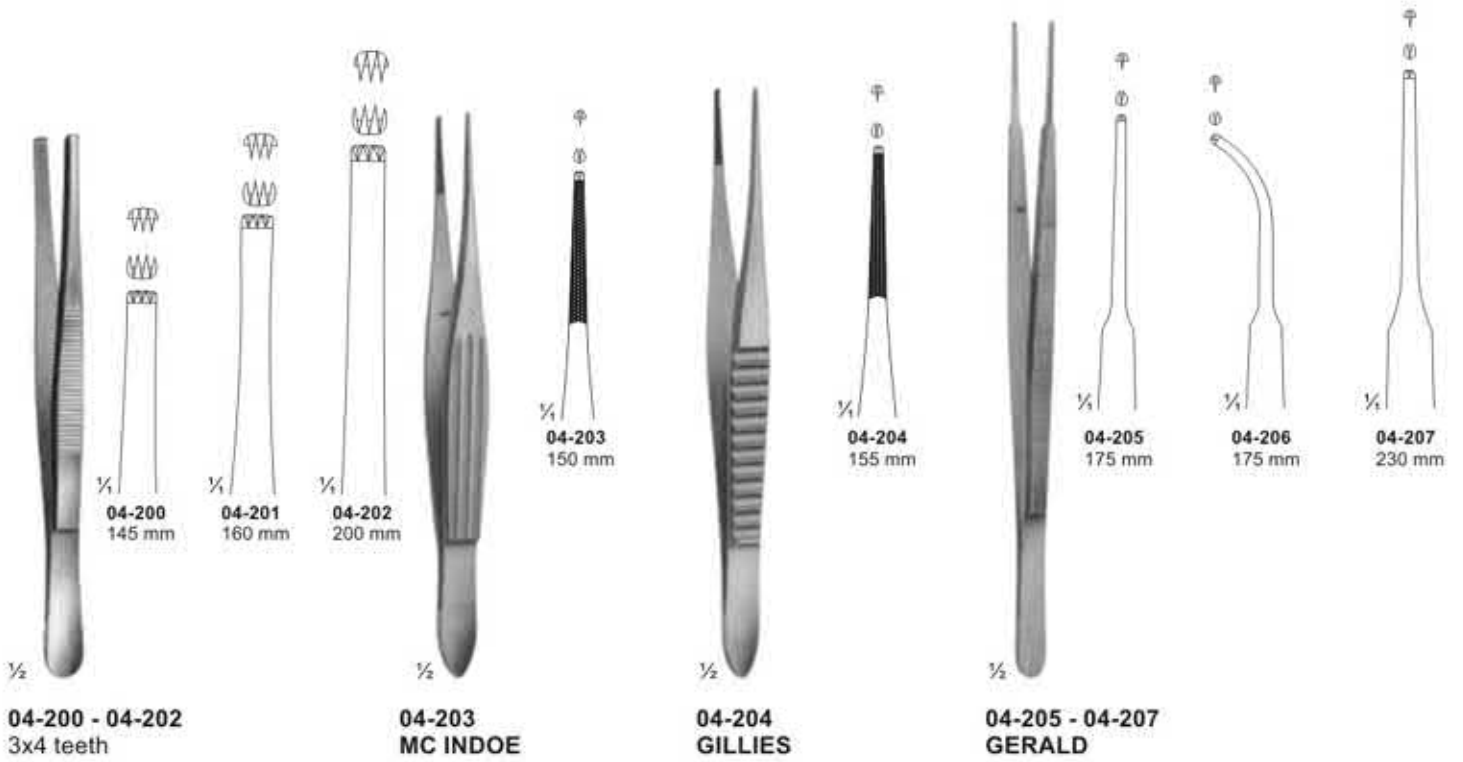

Tissue Forceps



04-213
ADSON - BROWN
 Non-traumatic
 120 mm

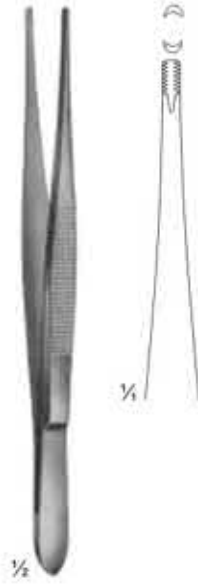

04-214
BROWN
 120 mm

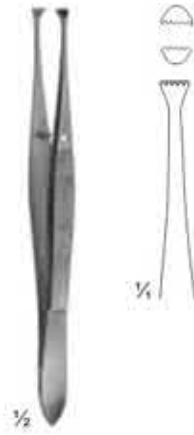

04-215
GRAEFE
 110 mm

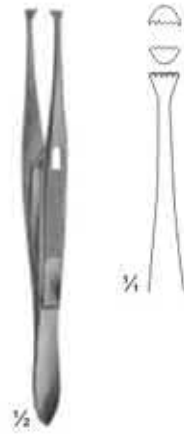

04-216
GRAEFE
 With Catch
 110 mm

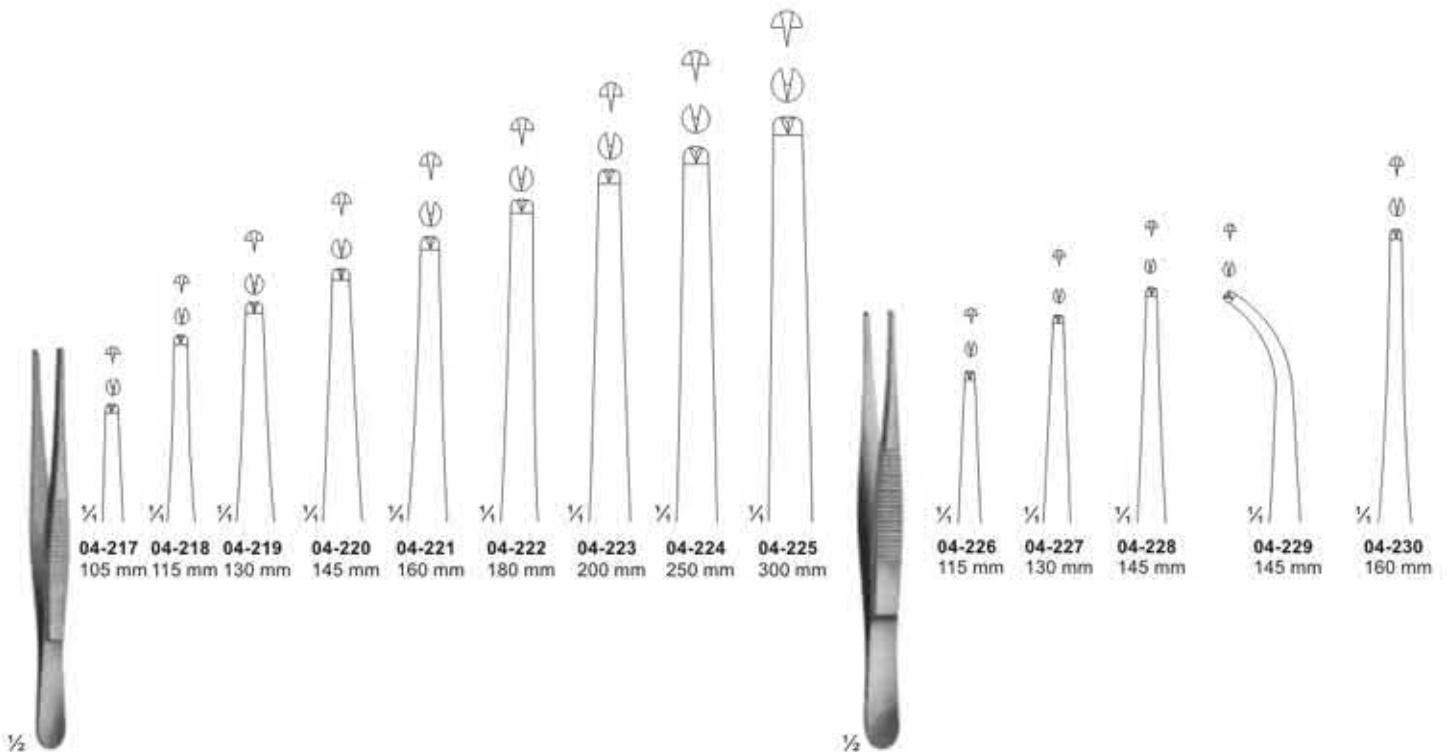

04-217 - 04-225
STANDARD

04-226 - 04-230
GRAEFE
 110 mm

Forceps, Bayonet - Shaped

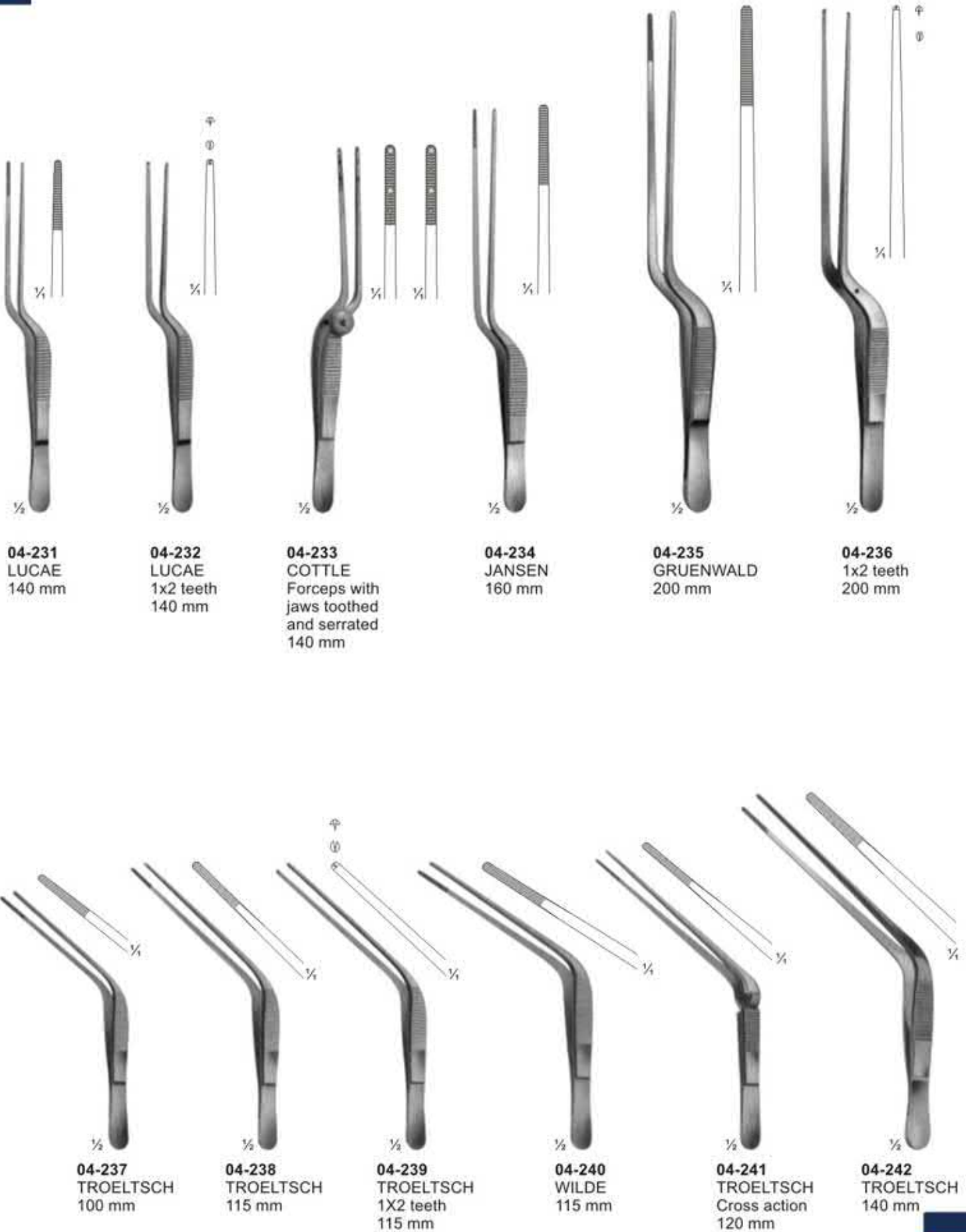

04-231
 LUCAE
 140 mm

04-232
 LUCAE
 1x2 teeth
 140 mm

04-233
 COTTLE
 Forceps with
 jaws toothed
 and serrated
 140 mm

04-234
 JANSEN
 160 mm

04-235
 GRUENWALD
 200 mm

04-236
 1x2 teeth
 200 mm

04-237
 TROELTSCH
 100 mm

04-238
 TROELTSCH
 115 mm

04-239
 TROELTSCH
 1X2 teeth
 115 mm

04-240
 WILDE
 115 mm

04-241
 TROELTSCH
 Cross action
 120 mm

04-242
 TROELTSCH
 140 mm

Tissue Forceps, Lung Dissecting Forceps

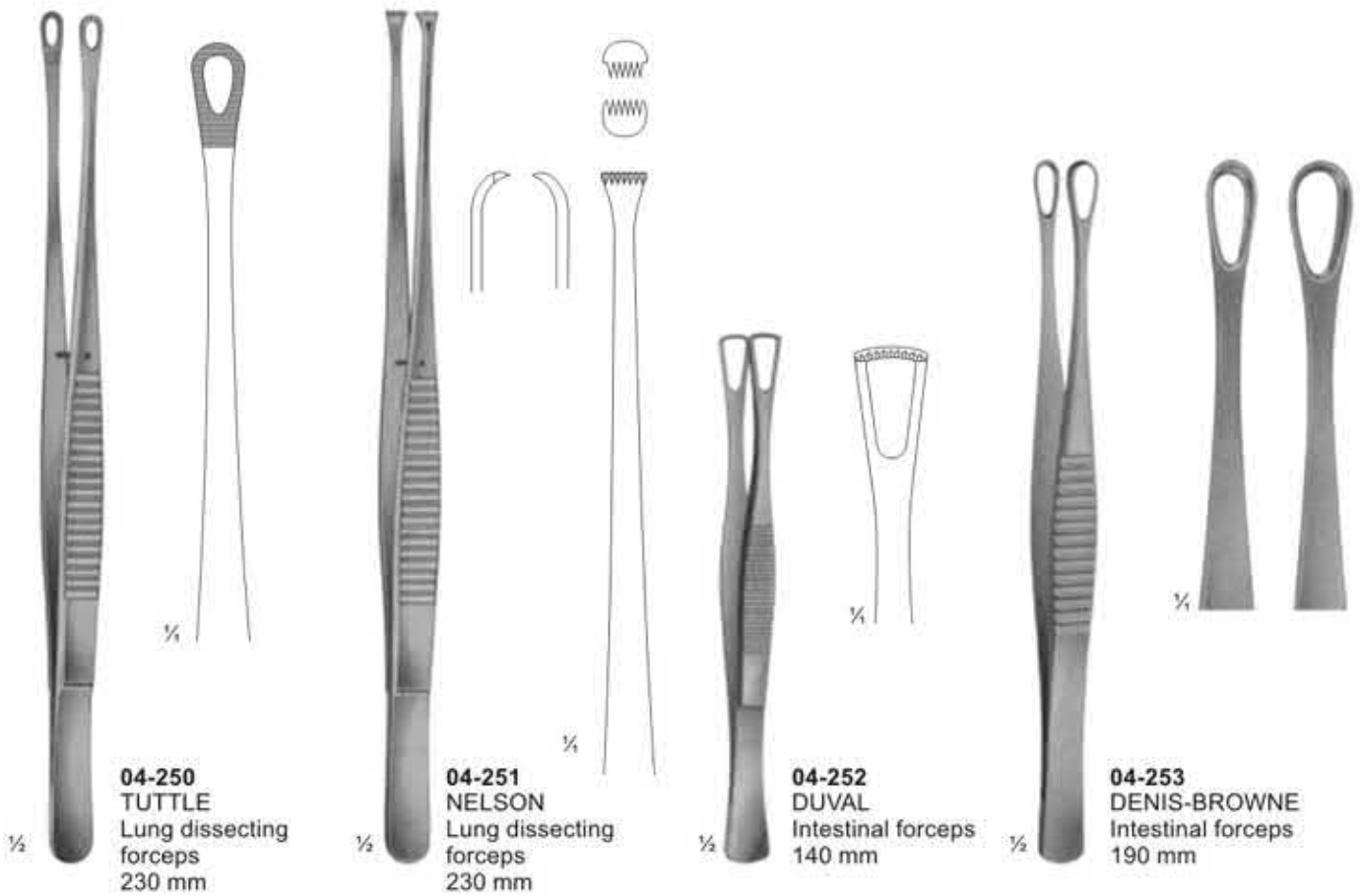
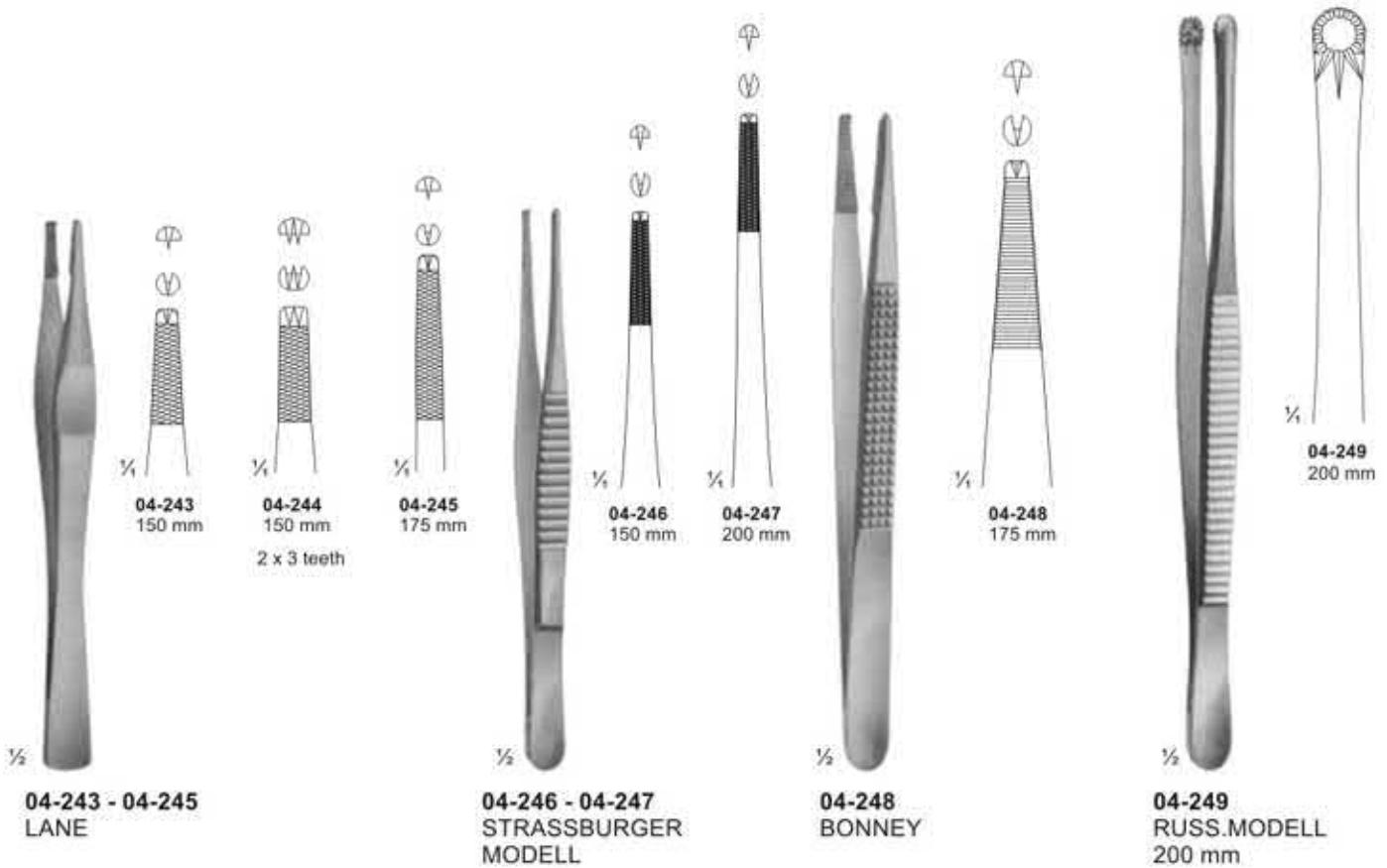

Splinter and Cilia Forceps

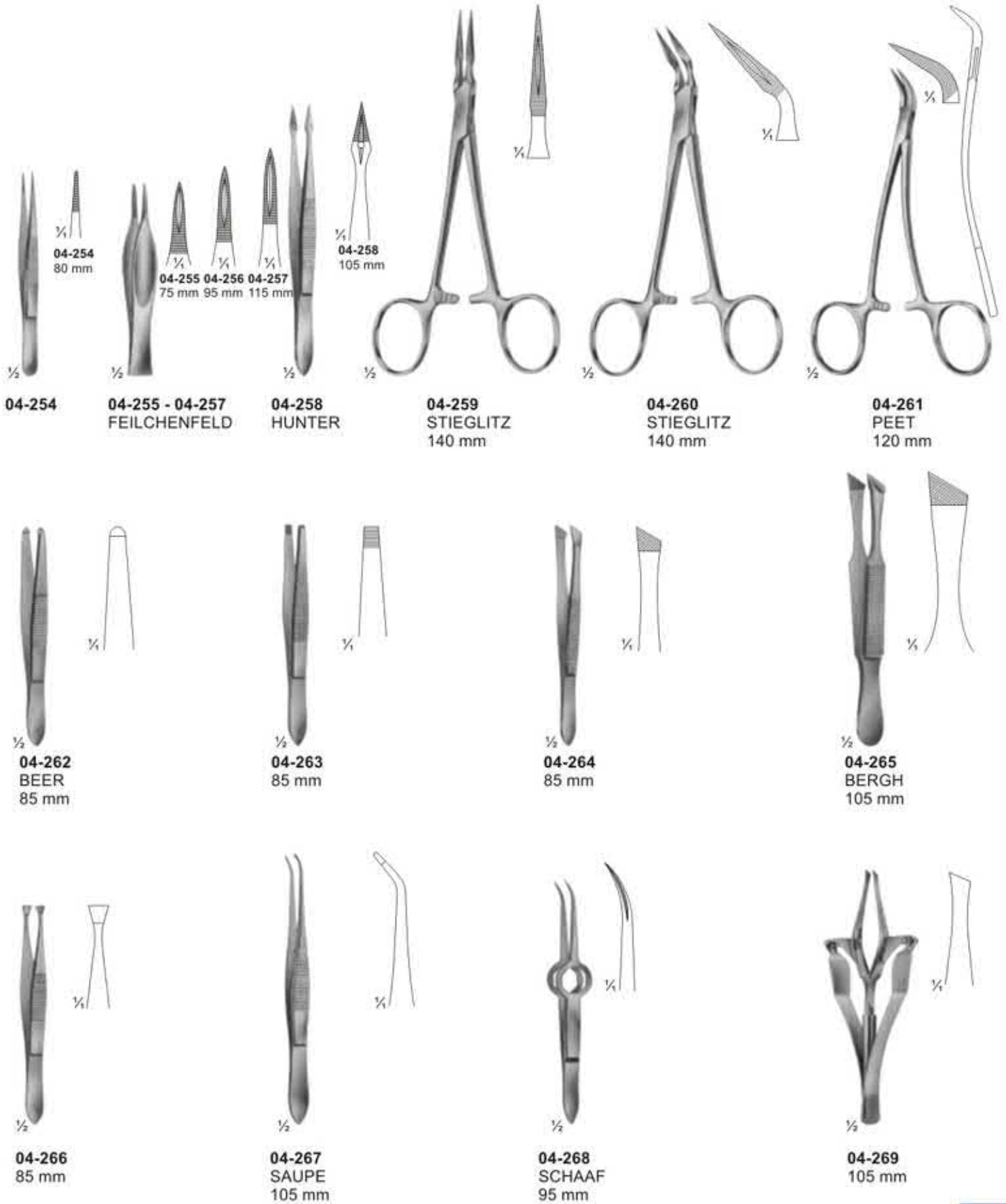

Sponge and Dressing Forceps

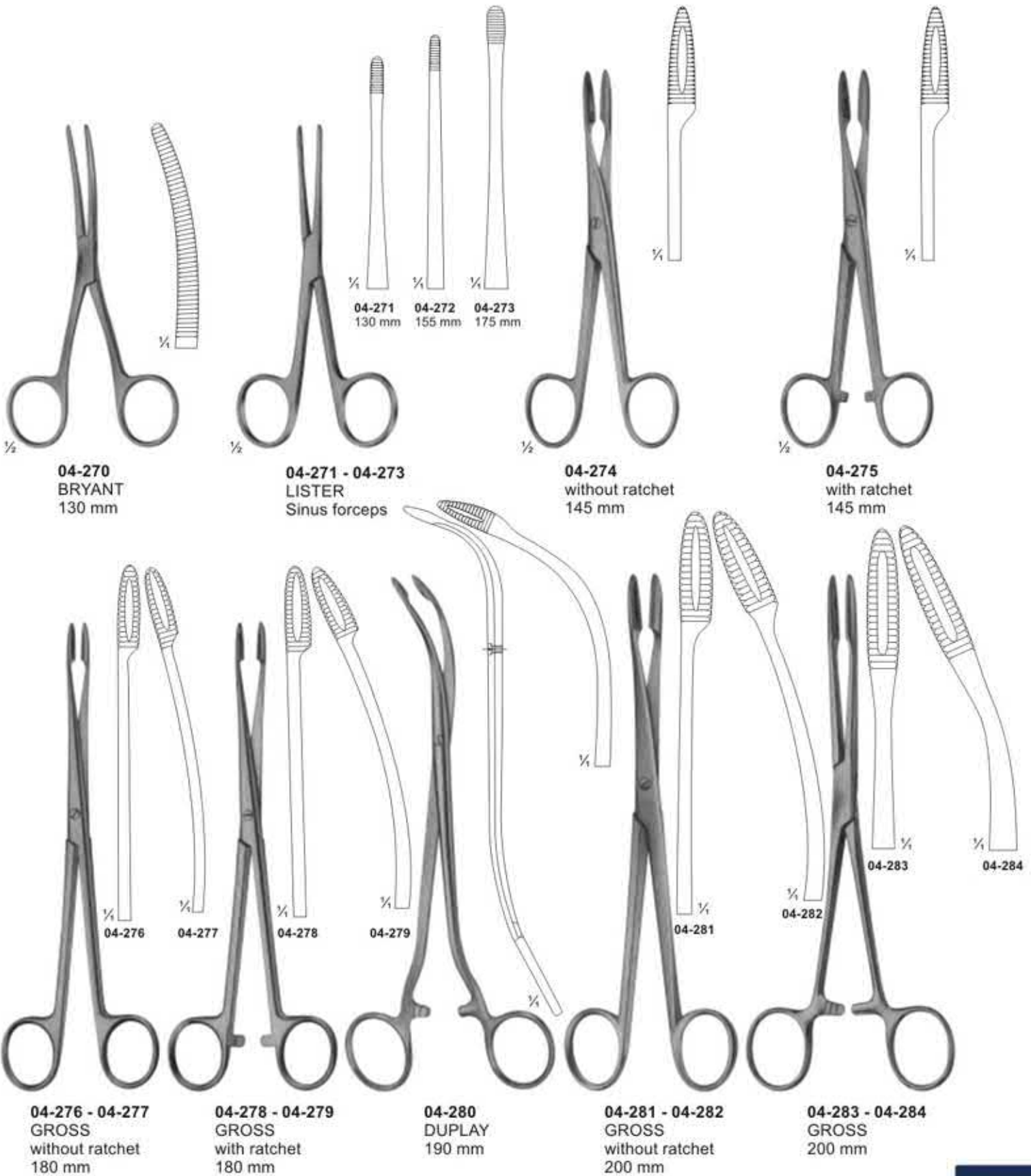

Dressing-, Sponge holding-, Organ- and Tissue Grasping Forceps



04-285 - 04-286
 COLLIN

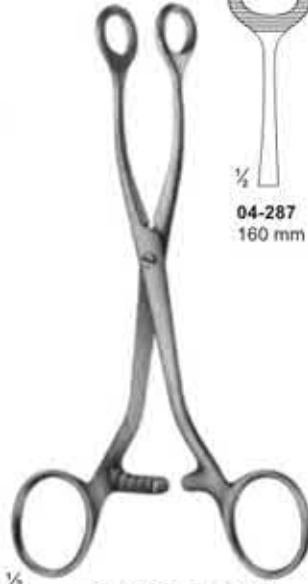
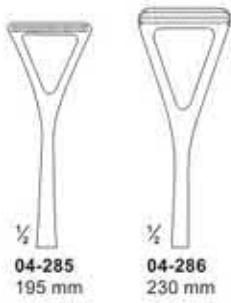

04-287 - 04-289
 COLLIN

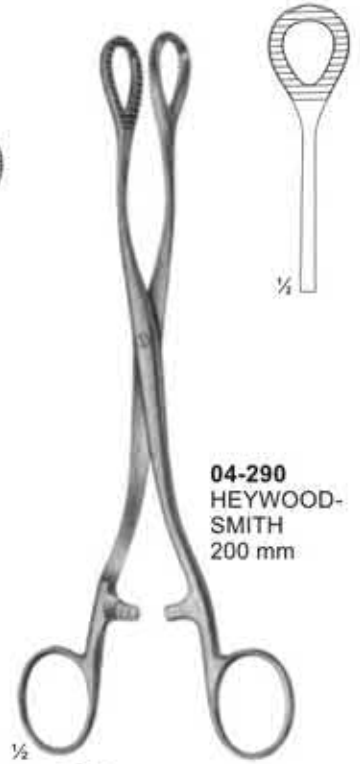

04-290
 HEYWOOD-SMITH
 200 mm



04-291
 NOTO
 280 mm



04-292
 KELLY
 320 mm



Dressing, Sponge holding, Organ and Tissue Grasping Forceps

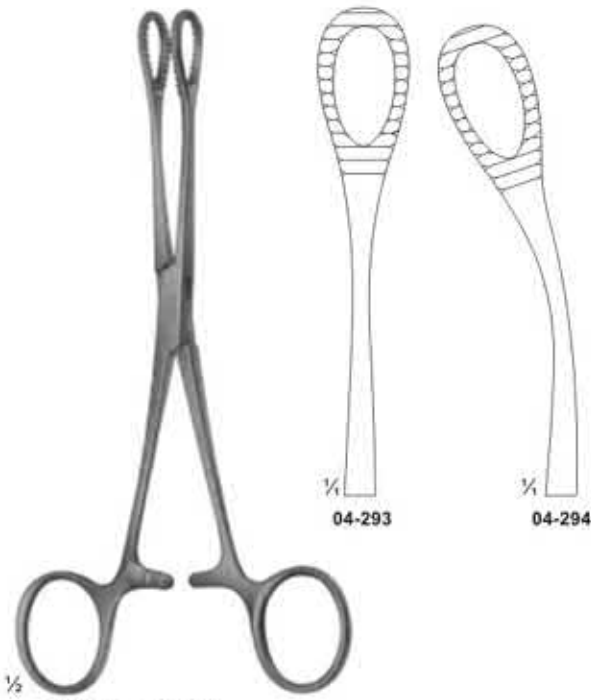

04-293 - 04-294
FOERSTER-BALLENGER
 180 mm

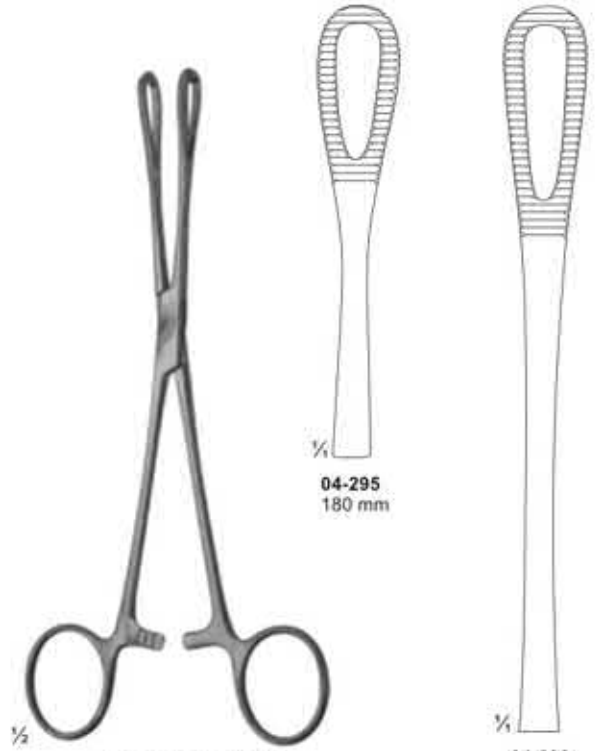

04-295 - 04-296
RAMPLEY

04-296
 250 mm



04-297 - 04-300
FOERSTER-BALLENGER
 240 mm

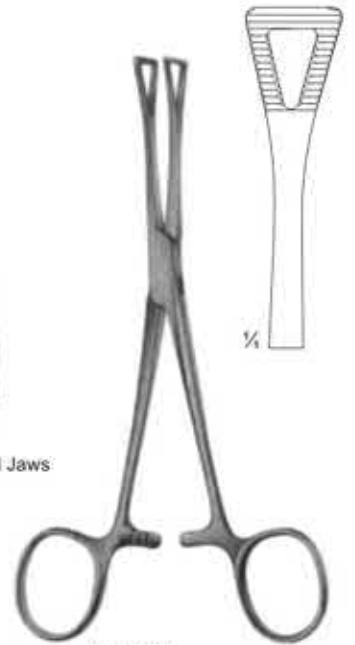

04-301
PENNINGTON
 155 mm

Intestinal Grasping Forceps

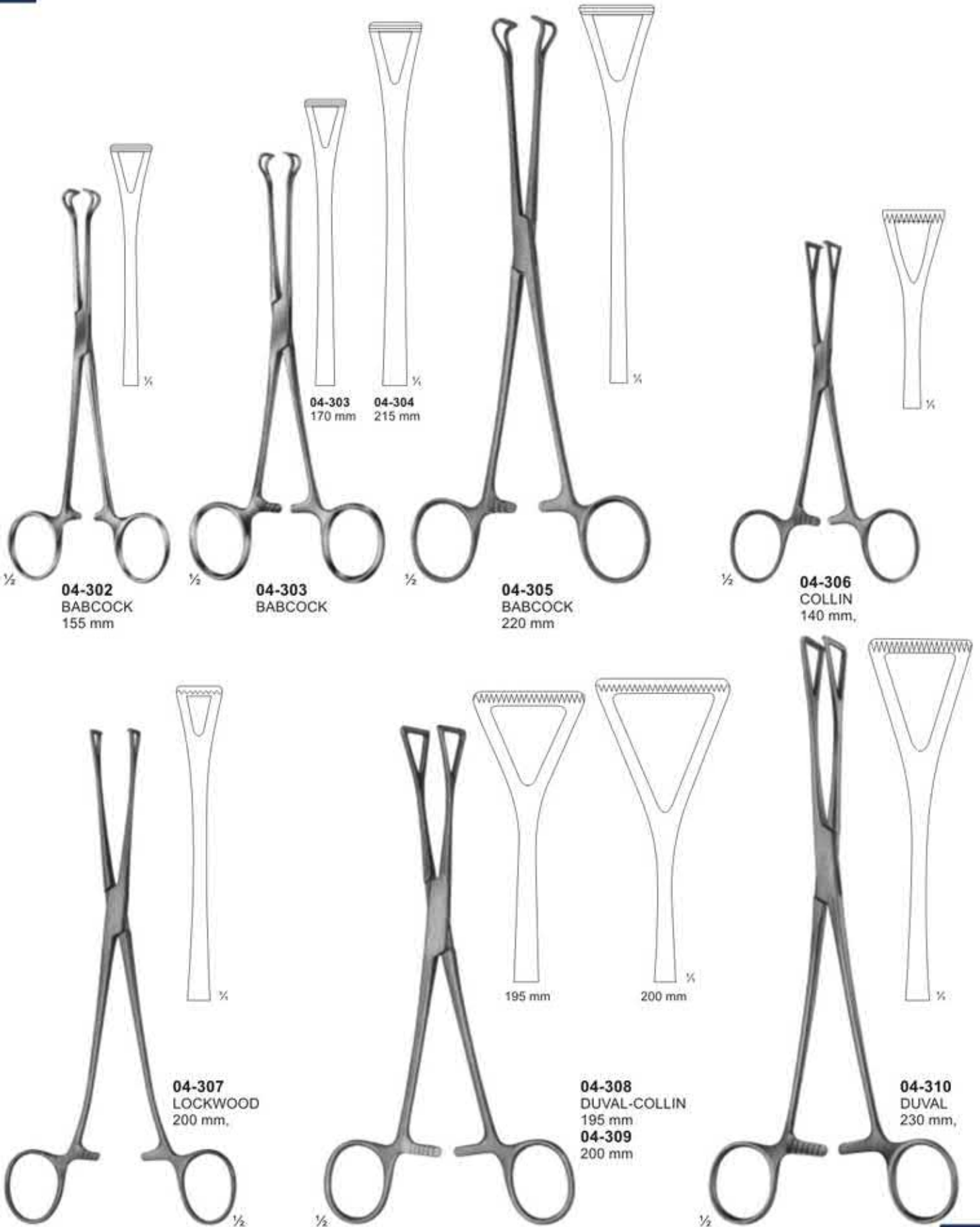

Artery Traction - and Tissue Grasping Forceps

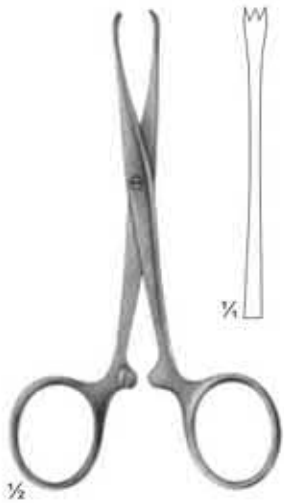

04-311
CHAPUT
 2 x 3 teeth
 125 mm

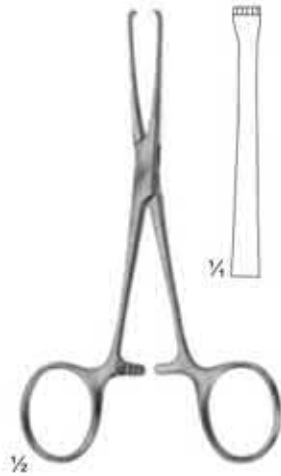

04-312
BABY-ALLIS
 4 x 5 teeth
 130 mm

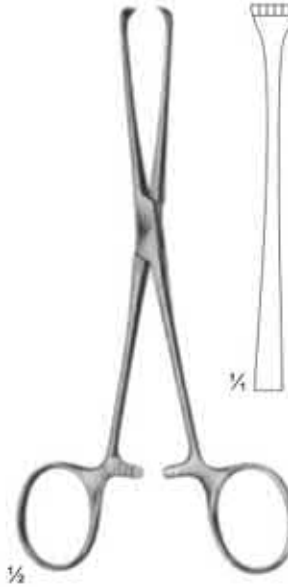

04-313
BOYS-ALLIS
 5 x 6 teeth sharp
 155 mm

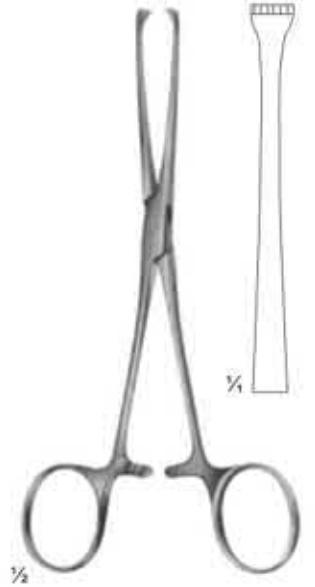

04-314
ALLIS
 5 x 6 teeth
 155 mm



04-315
LAHEY
 155 mm

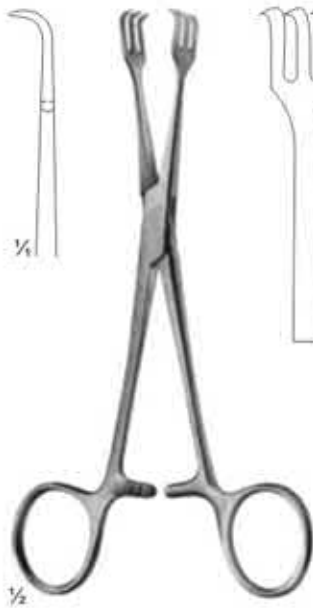

04-316
LAHEY
 155 mm

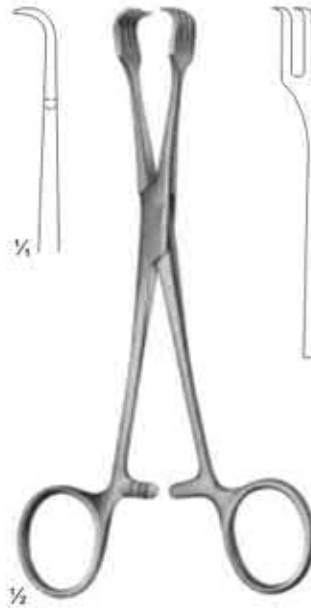

04-317
BRAUN
 155 mm

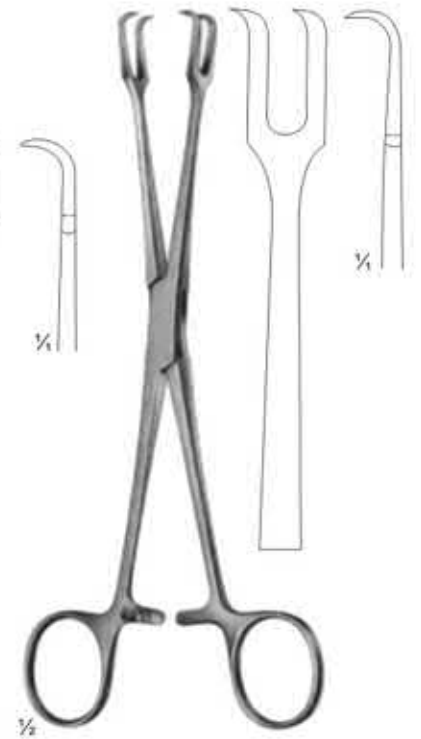

04-318
MUSEUX
 200 mm

Towel Clamps

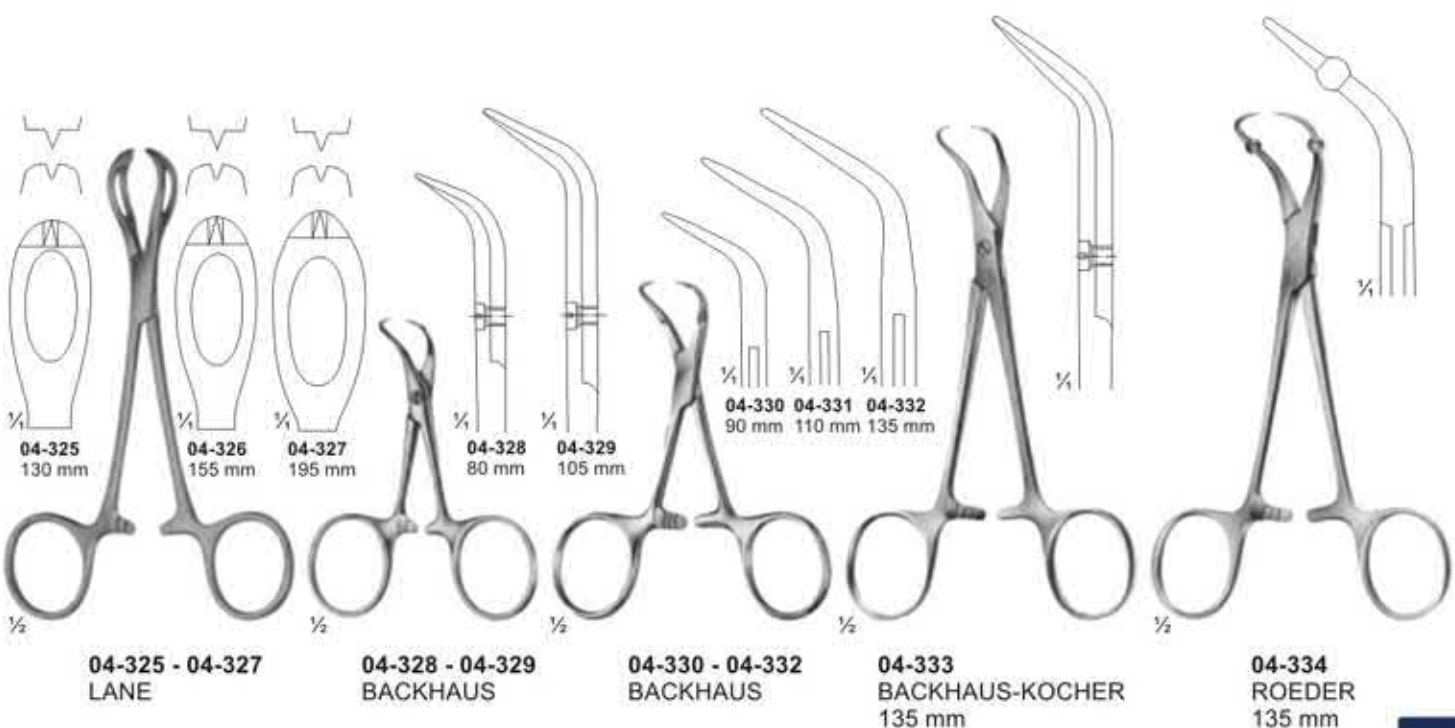

Muller Vessel Clips and Bulldog Clamps

Closing force

04-335 straight	04-336 curved	04-337 curved tips	04-338 angled shaped	04-339 MULLER knee-bent	04-340 Muller Ligature Forceps	
80g 50g	80g 50g	80g 50g	80g 50g	80g 50g	80g 50g	

04-341	04-342	04-343	04-344	04-345	04-346	04-347	04-348	04-349	04-350	04-351 - 04-357	04-358	
35 mm	35 mm	45 mm	45 mm	38 mm	38 mm	48 mm	38 mm	48 mm	58 mm	58 mm	91 mm	20 mm

04-359	04-360	04-361	04-362	04-363	04-364	04-365	04-366	04-367	04-368	04-369	04-373	04-374	04-375	04-376	04-377	04-378
length 50 mm jaws 27 mm	length 48 mm jaws 27 mm	GLOVER length 57 mm jaws 35 mm	DE BAKEY length 73 mm jaws 38 mm	DE BAKEY length 99 mm jaws 63 mm	DE BAKEY length 95 mm jaws 54 mm	L. 80 mm	L. 90 mm	L. 105 mm	L. 124 mm	L. 78 mm	GLOVER L. 68 mm	L. 96 mm	L. 117 mm	L. 65 mm	L. 91 mm	L. 110 mm

Delicate Haemostatic Forceps

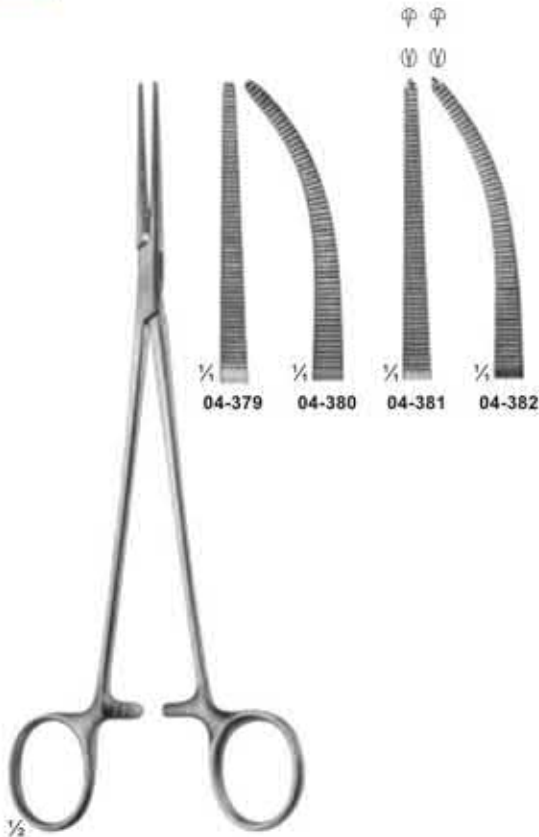

04-379 - 04-382
 HALSTED-MOSQUITO
 200 mm



04-383 - 04-387
 HEISS
 200 mm



04-388 - 04-389
 HALSTED
 215 mm

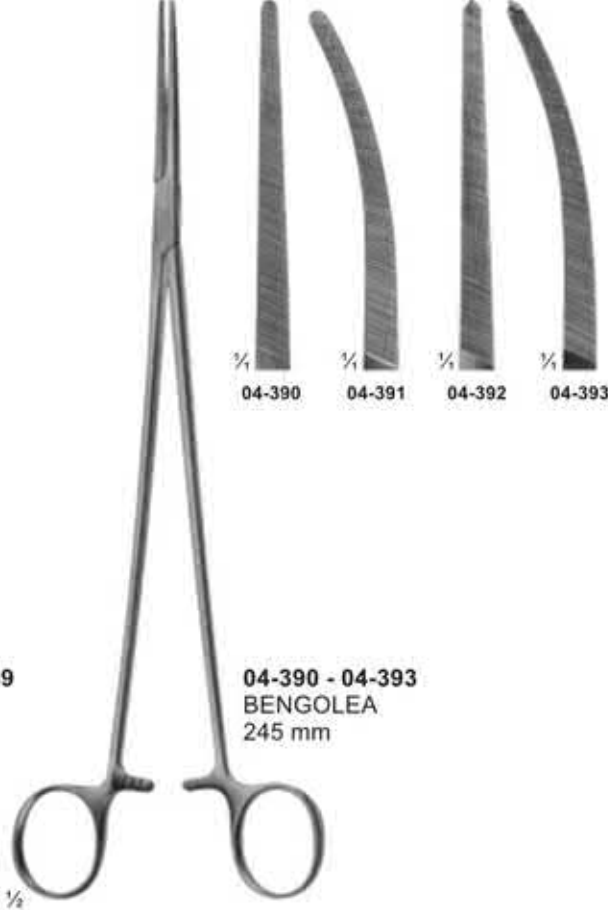

04-390 - 04-393
 BENGOLEA
 245 mm



04-394
 CRAFOORD
 245 mm

Delicate Haemostatic Forceps



04-395
 CARREL
 85 mm



04-396 - 04-399
 BABY-MOSQUITO
 (HARTMANN)
 100 mm

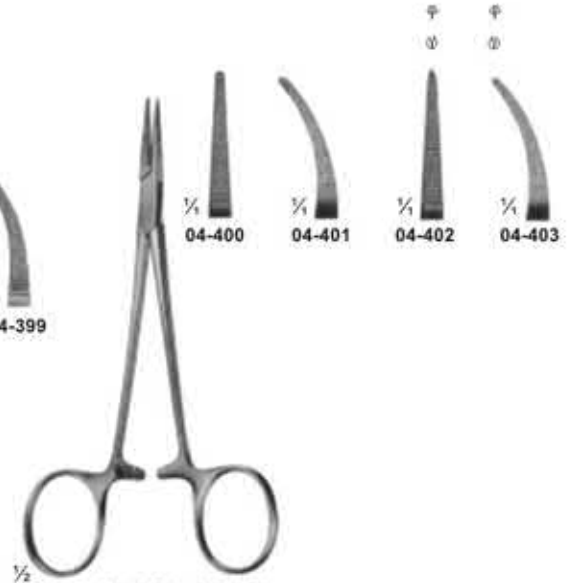

04-400 - 04-403
 MICRO-HALSTED
 125 mm



04-404 - 04-407
 HALSTED-MOSQUITO
 125 mm

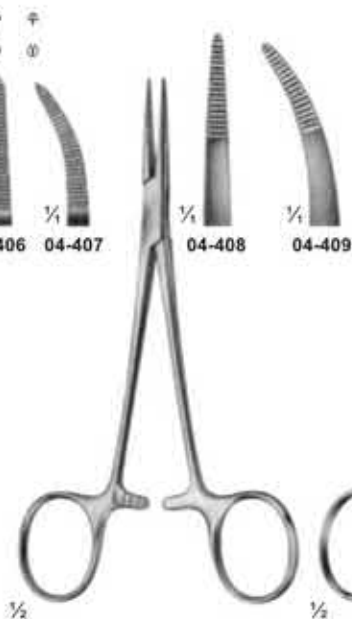

04-408 - 04-409
 PROVIDENCE-HOSPITAL
 140 mm



04-410 - 04-411
 KELLY
 140 mm

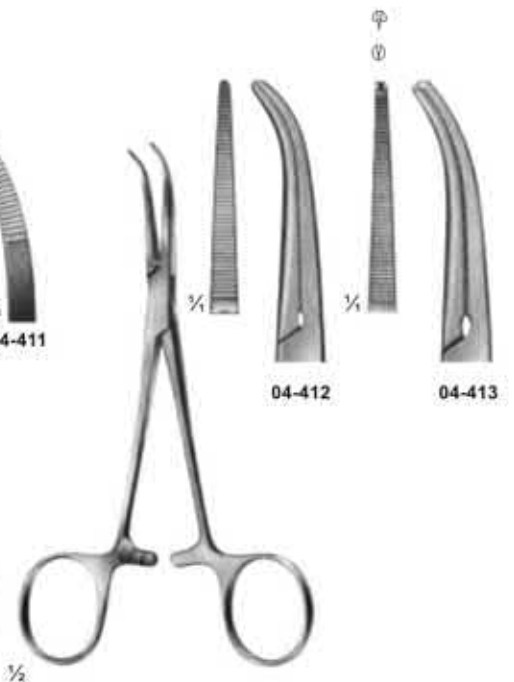

04-412 - 04-413
 DANDY
 Curved sideways
 140 mm

Delicate Haemostatic Forceps

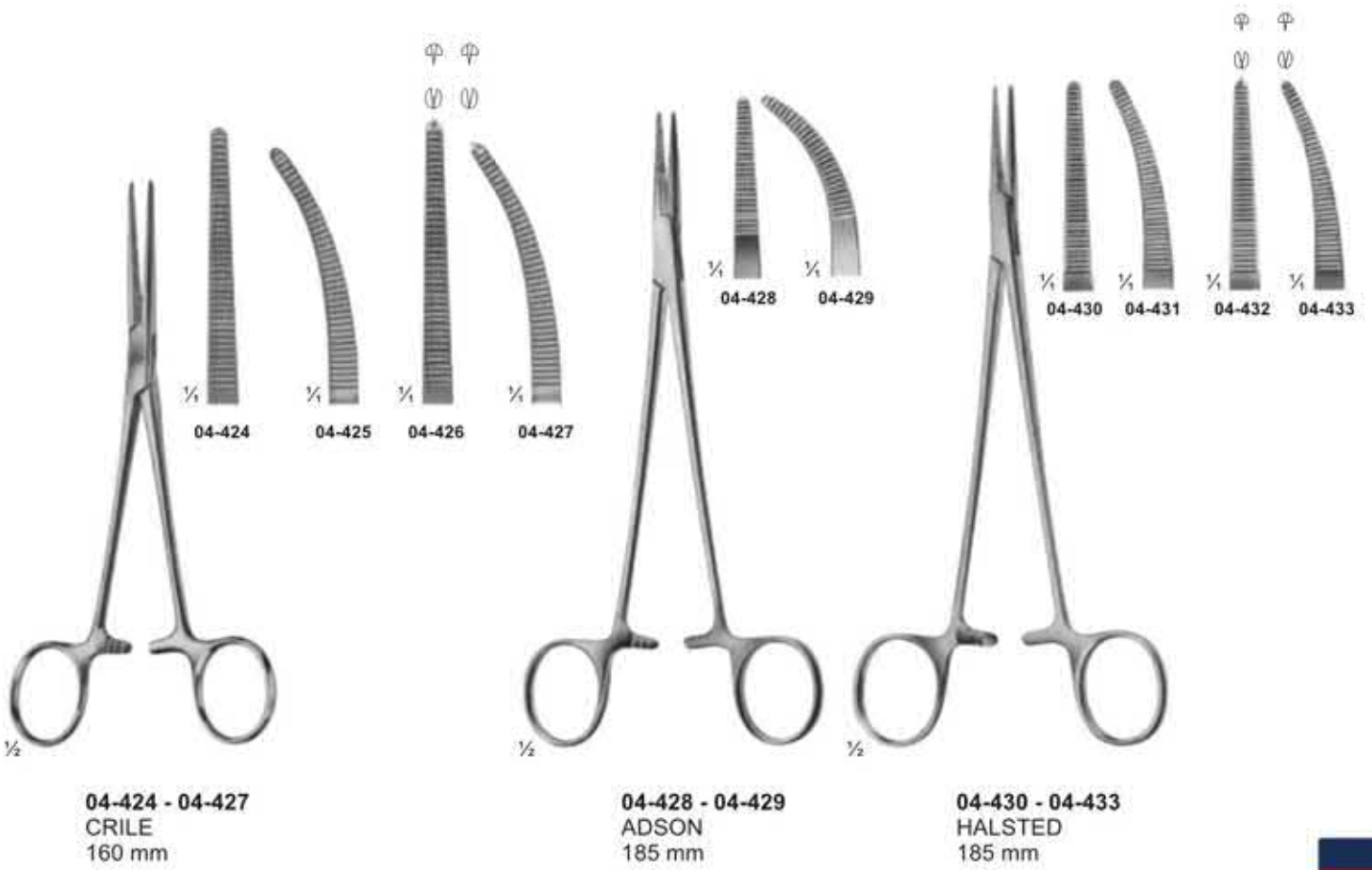
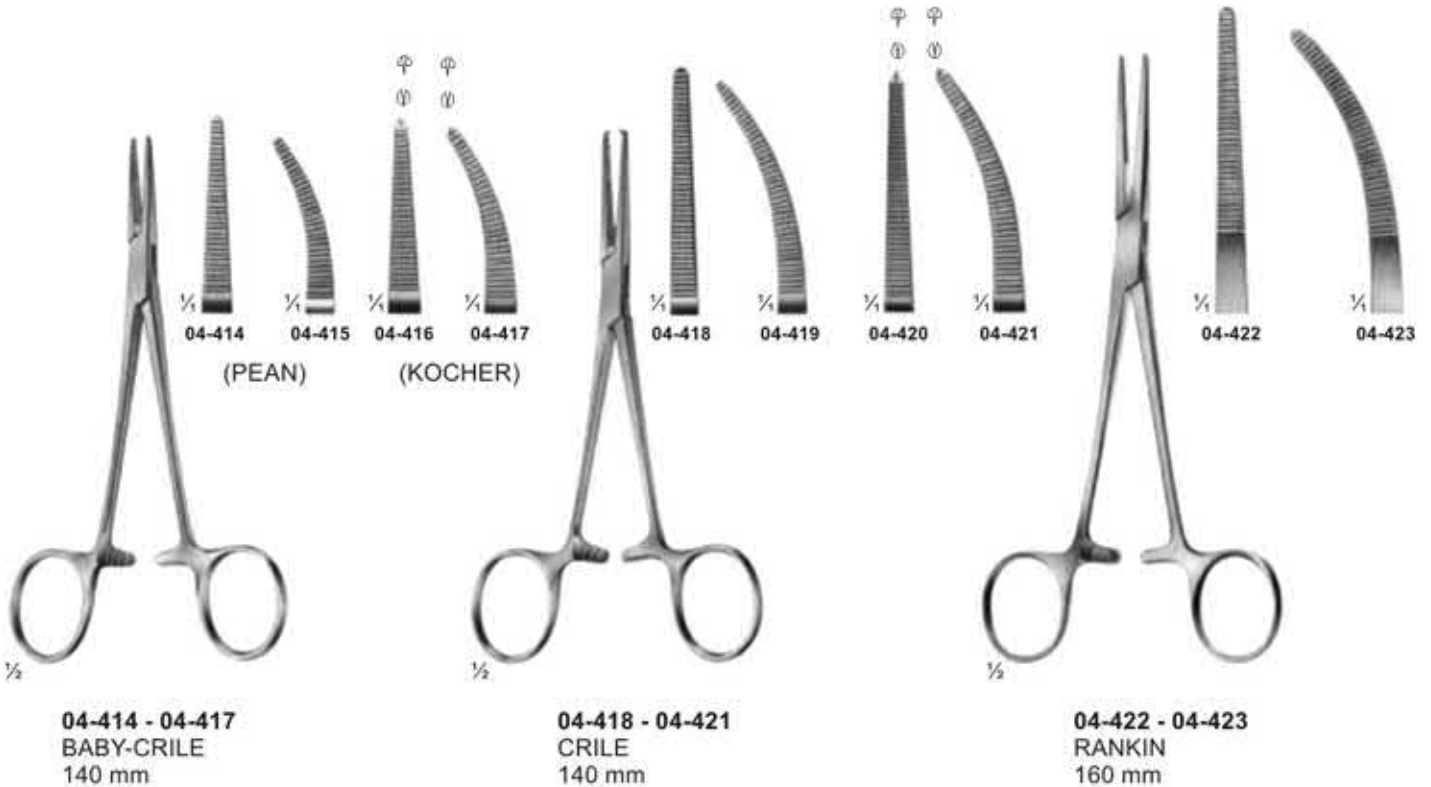

Haemostatic Forceps

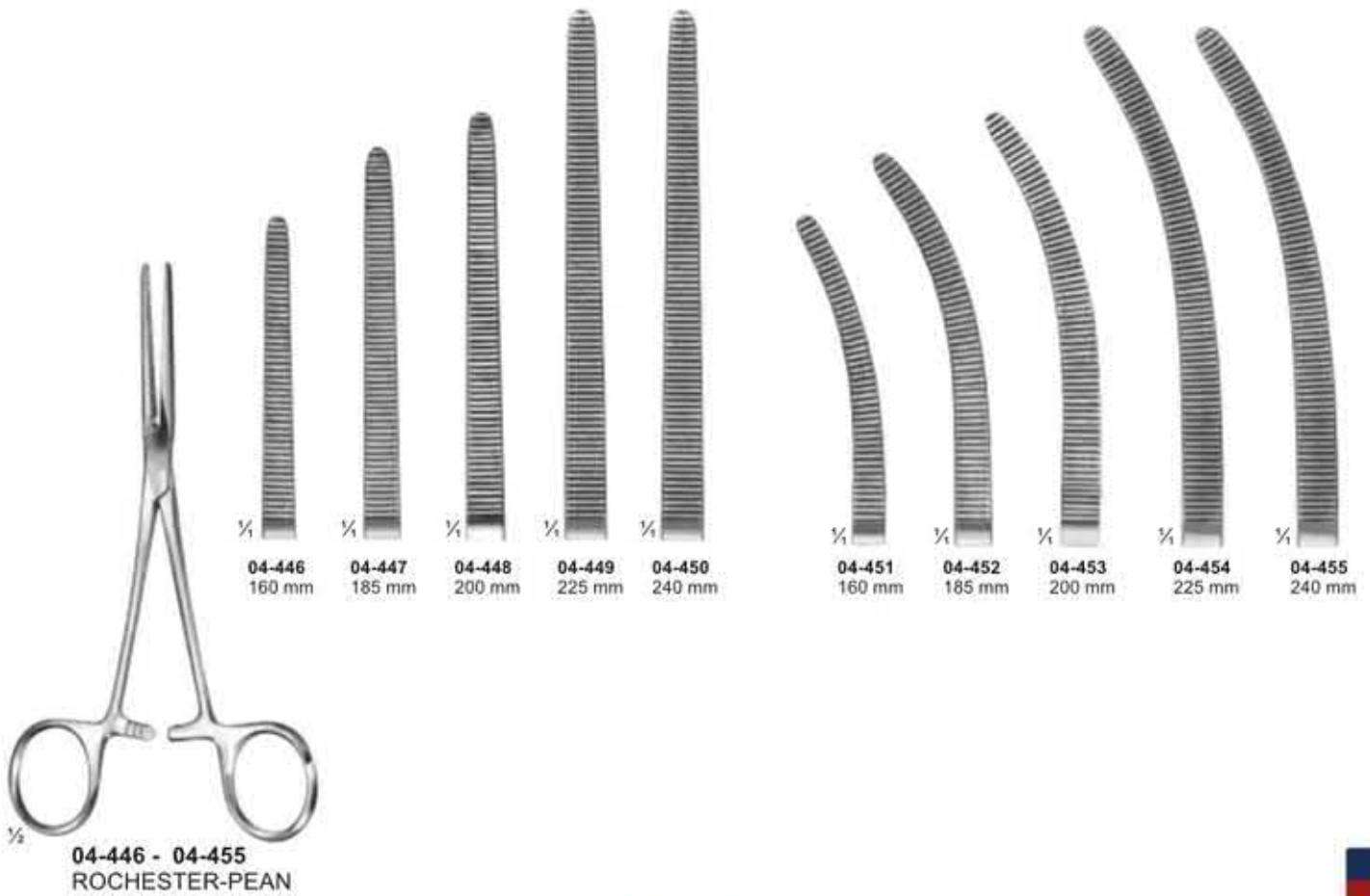

Haemostatic Forceps



04-456 - 04-461
 PEAN

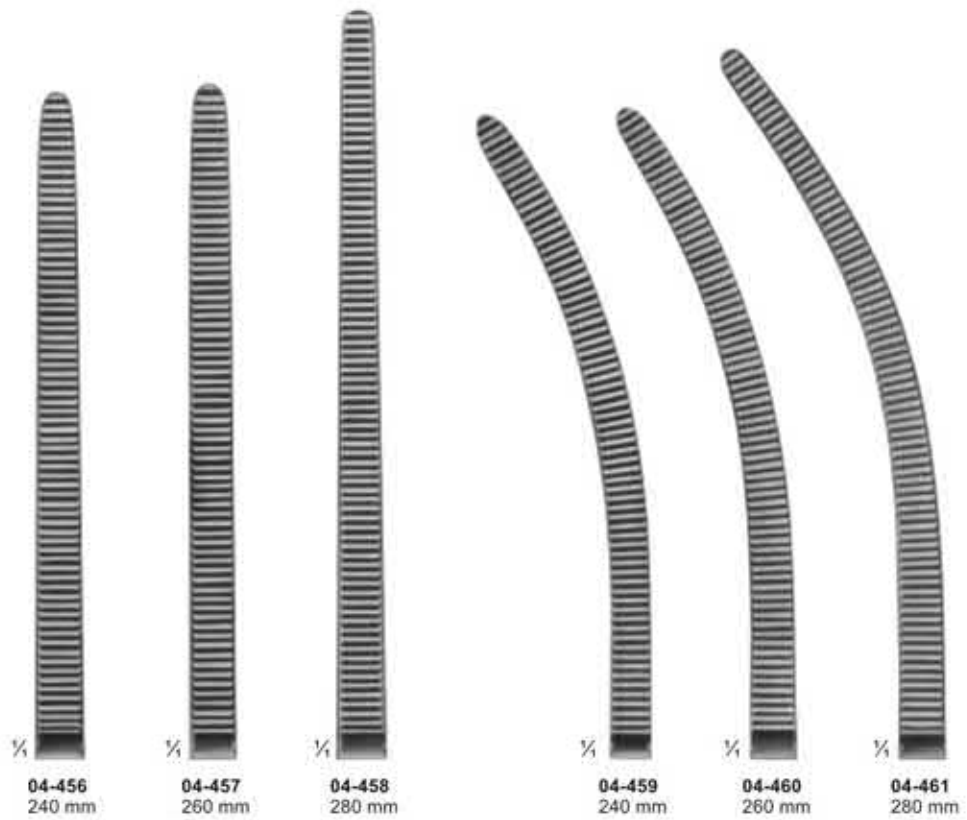

04-462
 KOCHER
 Strong Pattern
 145 mm

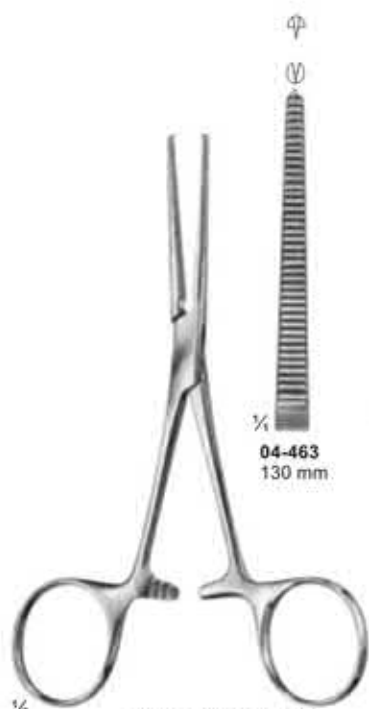

04-463 - 04-465
 KOCHER

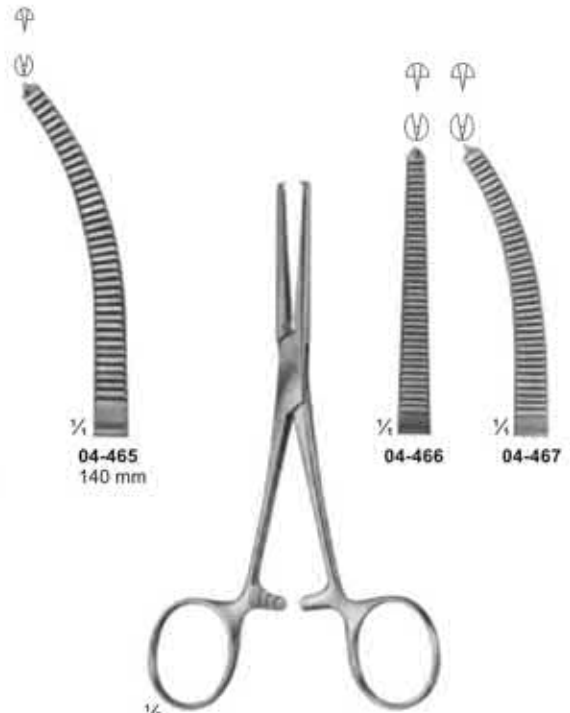

04-466 - 04-467
 ROCHESTER-OSHSNER
 140 mm

Haemostatic Forceps

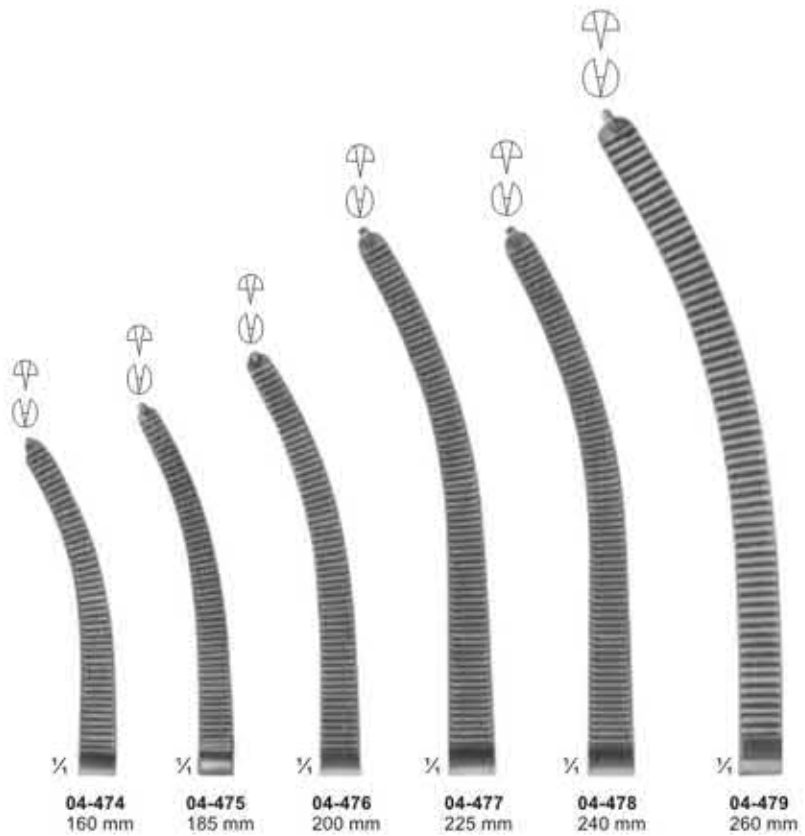
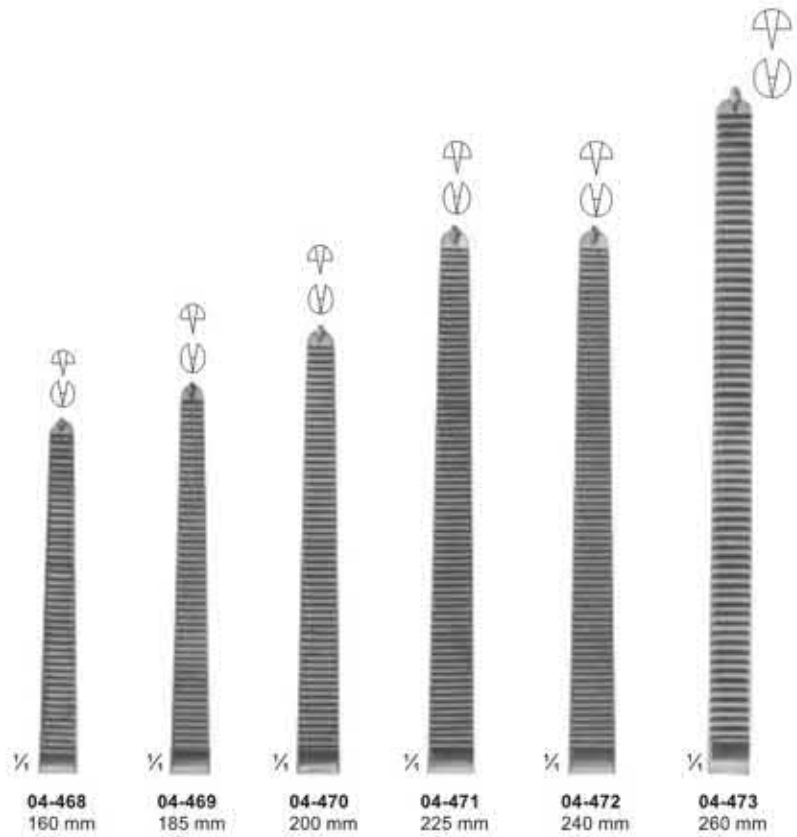

04-468 - 04-479
 KOCHER-OCHSNER

Haemostatic Forceps

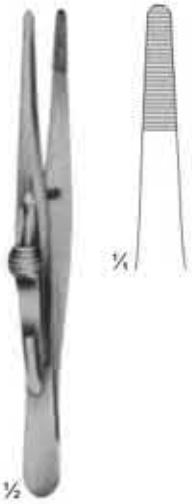

04-480
FRICKE
 Artery forceps
 130 mm



04-481
KRONLEIN
 130 mm



04-482
PEAN
 125 mm



04-483
 125 mm



04-484
 140 mm

04-483 - 04-484
PEAN



04-485
PEAN
 125 mm



04-486
 165 mm

04-487
 185 mm

04-486 - 04-487
PEAN

Haemostatic Forceps, Special Pattern, Tonsil Forceps

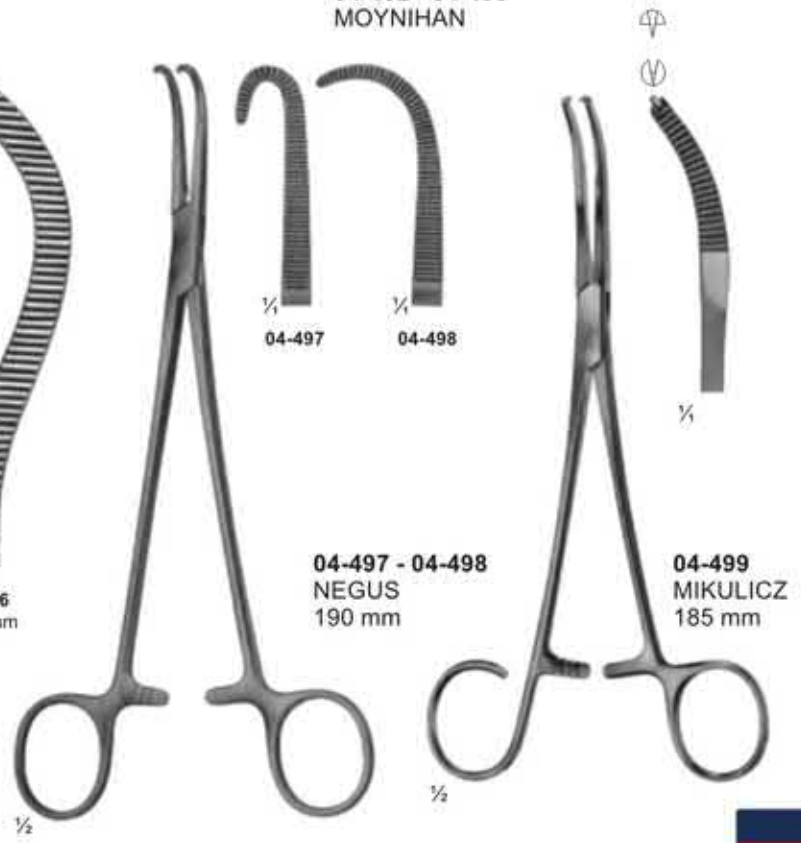
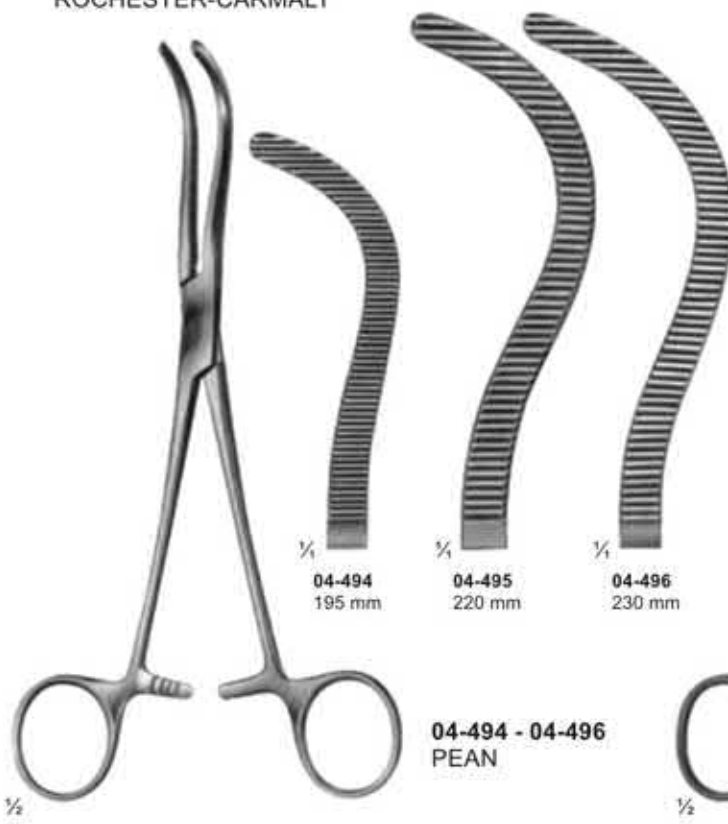
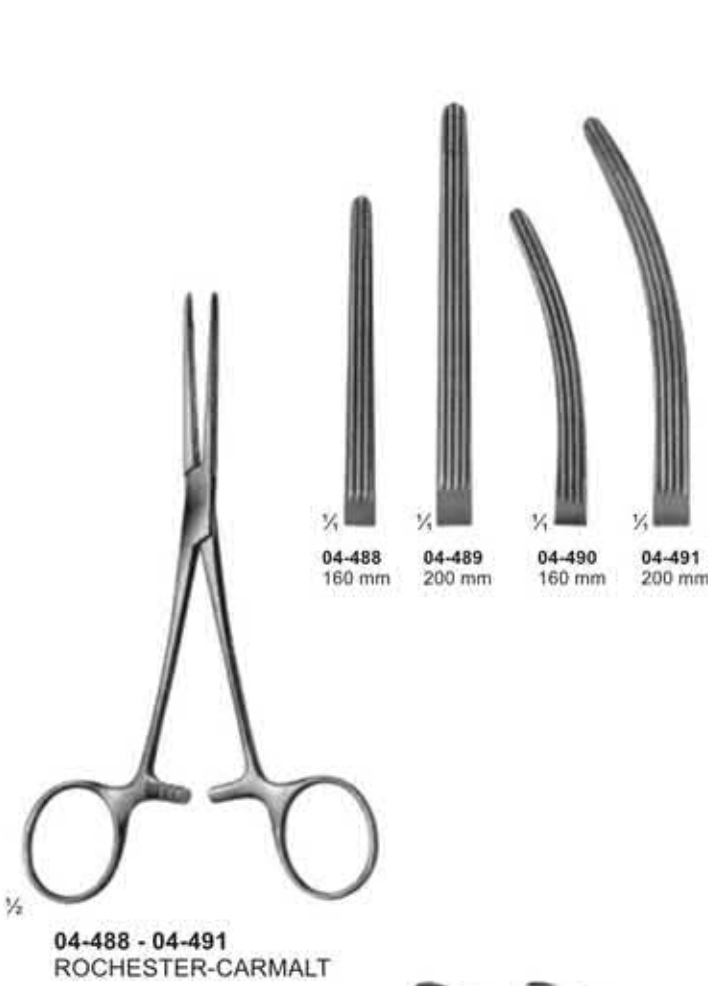

Dissecting- and Ligature Forceps



1/4
04-500
 MIXTER-O'SHAUGNESSY
 190 mm



1/4
04-501
 HEISS
 195 mm

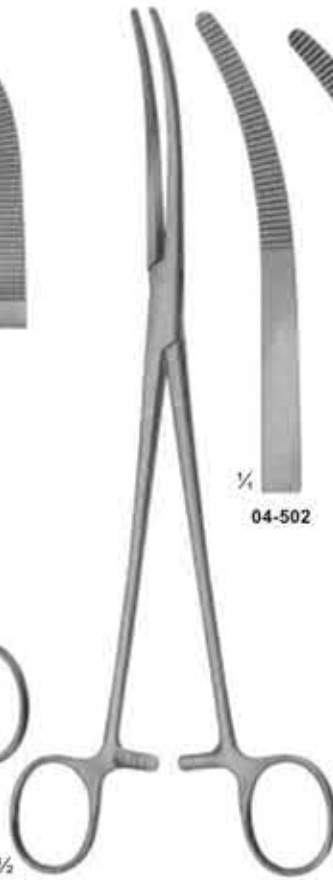

1/4
04-502 - 04-506
 RUMEL
 240 mm

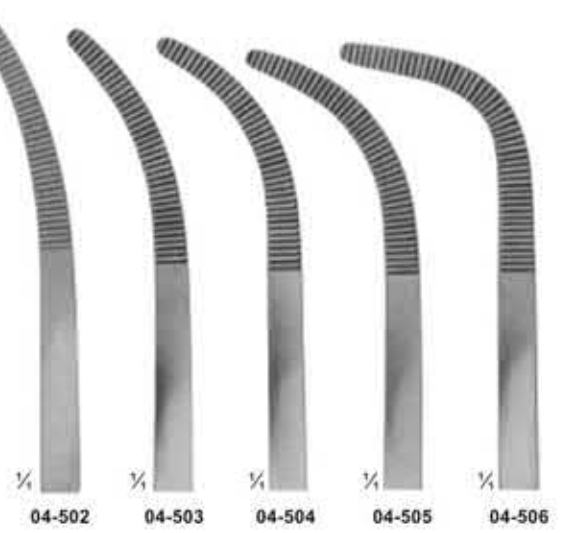

1/4 04-502 1/4 04-503 1/4 04-504 1/4 04-505 1/4 04-506

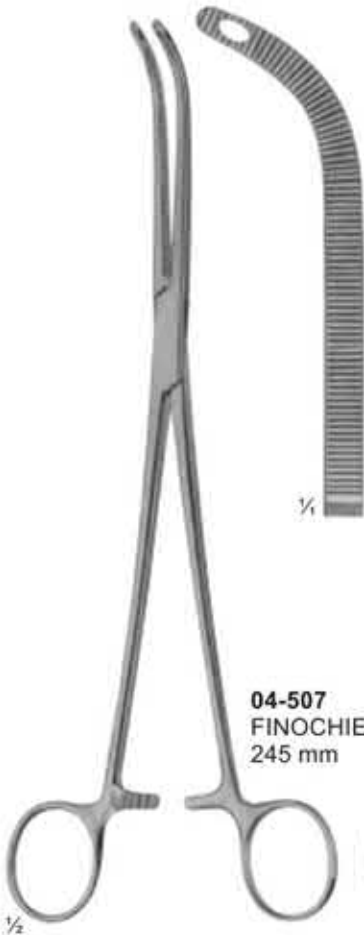

1/4
04-507
 FINOCHIETTO
 245 mm



1/4
04-508
 MIXTER
 230 mm



1/4
04-509
 LAWRENCE
 270 mm

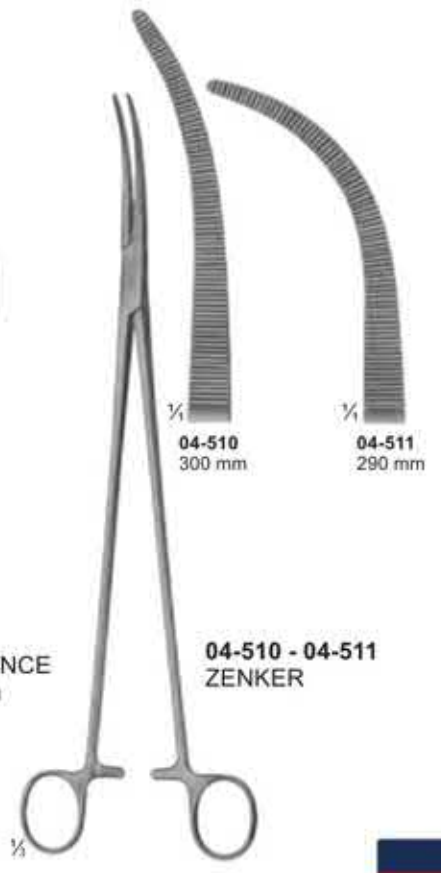

1/4
04-510
 300 mm

1/4
04-511
 290 mm

04-510 - 04-511
 ZENKER

**Hysterectomy Forceps, Vaginal Clamps
 and Compression Forceps**



04-512
WERTHEIM
 Hysterectomy forceps
 255 mm

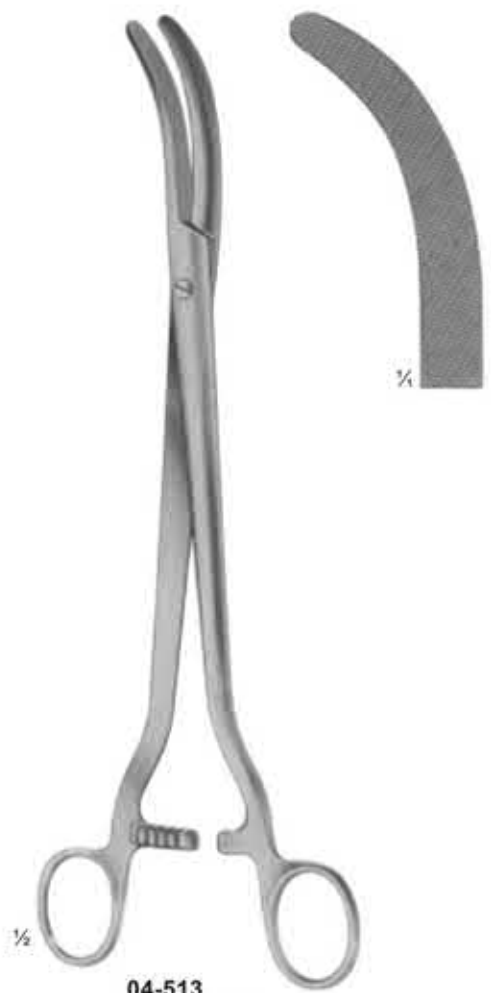

04-513
WERTHEIM
 Parametrium clamp
 260 mm

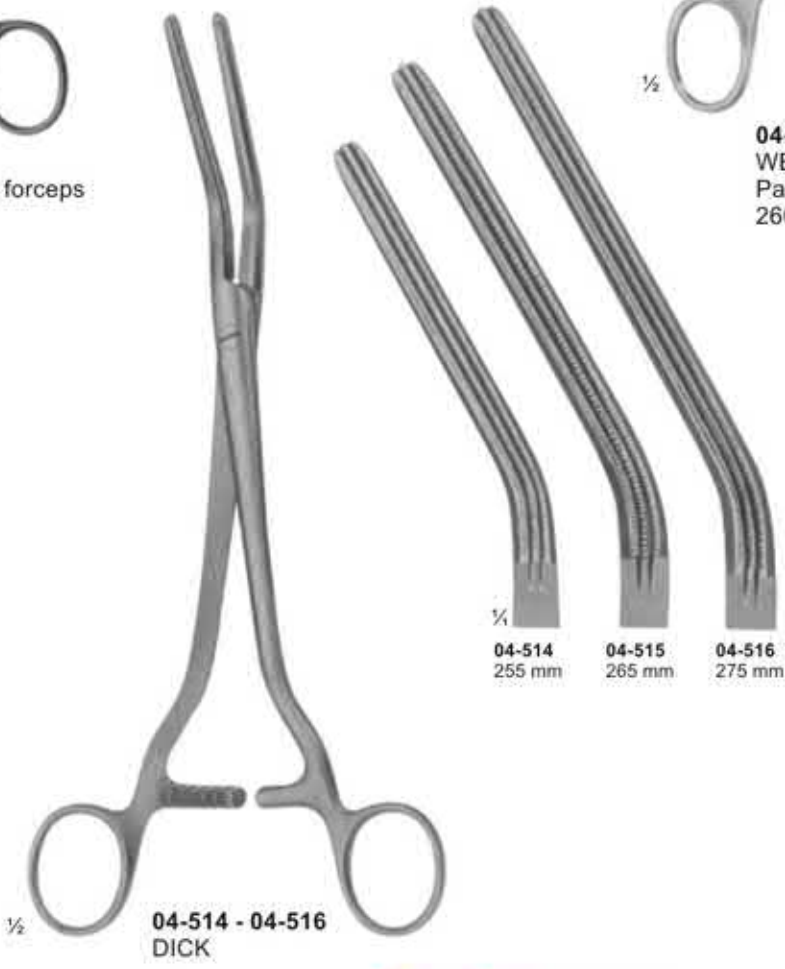

04-514 - 04-516
DICK

04-514 255 mm
04-515 265 mm
04-516 275 mm

**Hysterectomy Forceps, Vaginal Clamps
 and Compression Forceps**



04-517
WERTHEIM
 250 mm

½

¼



04-518
WERTHEIM-CULLEN
 215 mm

½

¼



04-519
 60 mm

04-520
 80 mm

¼

¼

½

04-519 - 04-520
 230 mm

Needle Holders for micro surgery



05-101
ROHRSCHEIDER
 with copper inserts
 100 mm



05-102
KALT
 with catch
 135 mm



05-103
ARRUGA
 with catch
 135 mm



05-104 - 105
CASTROVIEJO
 with catch
 145 mm



05-106 - 107
 without Catch
 160 mm



05-108 - 109
 without catch
 185 mm



05-110 - 111
JACOBSON
 185 mm



05-112
 without catch
 195 mm



05-113 - 114
YASARGIL
 with catch
 200 mm

Needle Holders

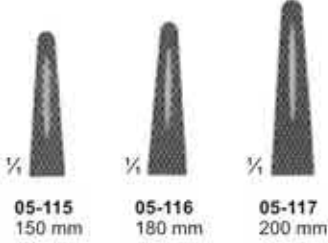

05-115
150 mm

05-116
180 mm

05-117
200 mm

05-115 - 117
MAYO-HEGAR
medium fine patterns

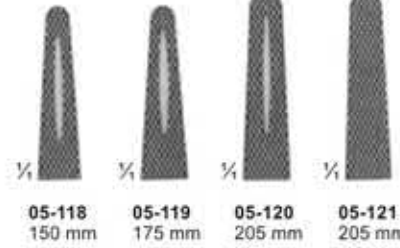
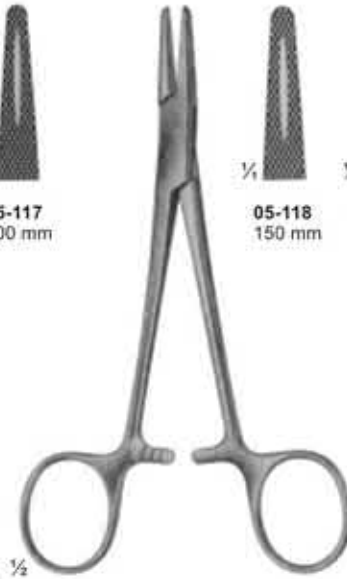

05-118
150 mm

05-119
175 mm

05-120
205 mm

05-121
205 mm

05-118 - 121
HEGAR
heavy patterns



05-122
HEANEY (HEGAR)
200 mm

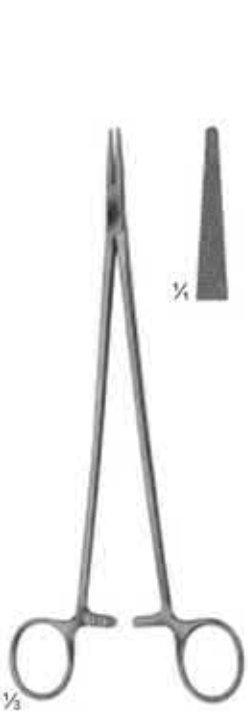

05-123
JAMESON
230 mm



05-124
WANGENSTEEN
275 mm



05-125
MASSON
265 mm

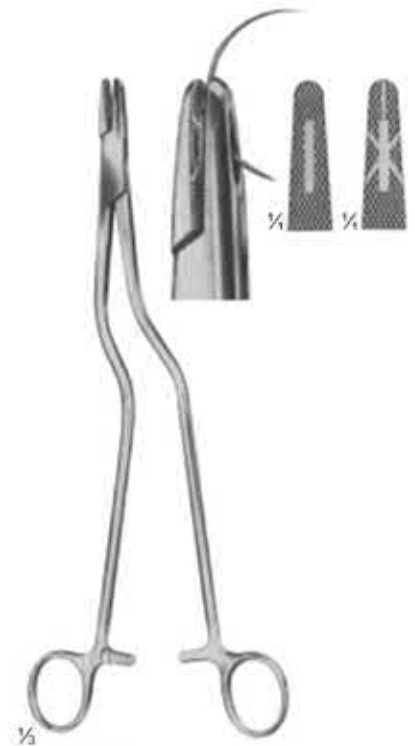

05-126
MASSON-LUETHY
255 mm

Needle Holders

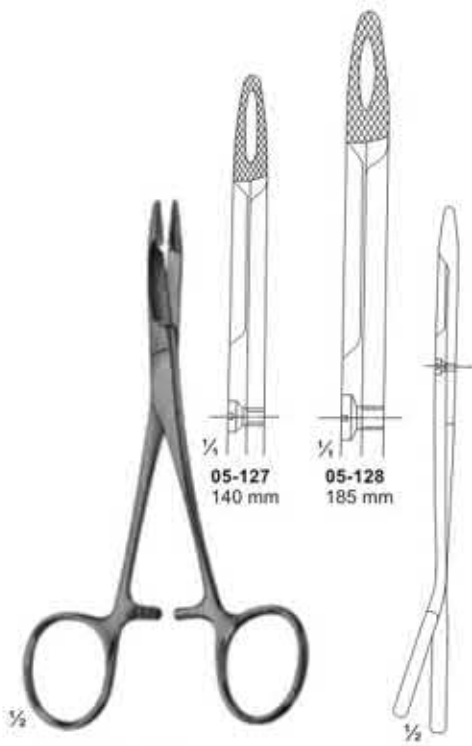

05-127 - 128
HEGAR-OLSEN
 255 mm

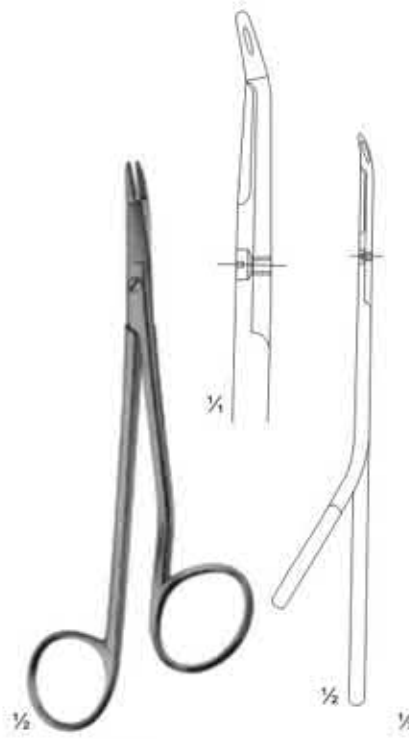

05-129
GILLIES
 150 mm

05-130
GILLIES
 160 mm

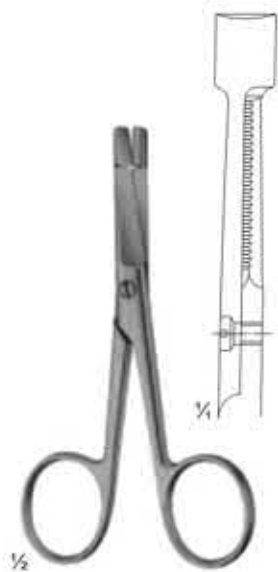

05-131
EISELSBERG
 115 mm

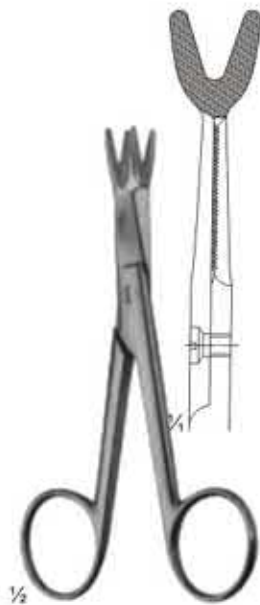

05-132
SCHOEMAKER-LOTH
 125 mm



05-133
CRILE
 150 mm



05-134
TOENNIS
 Elastic pattern for dura-or
 intestinal suture. 180 mm

Needle Holders

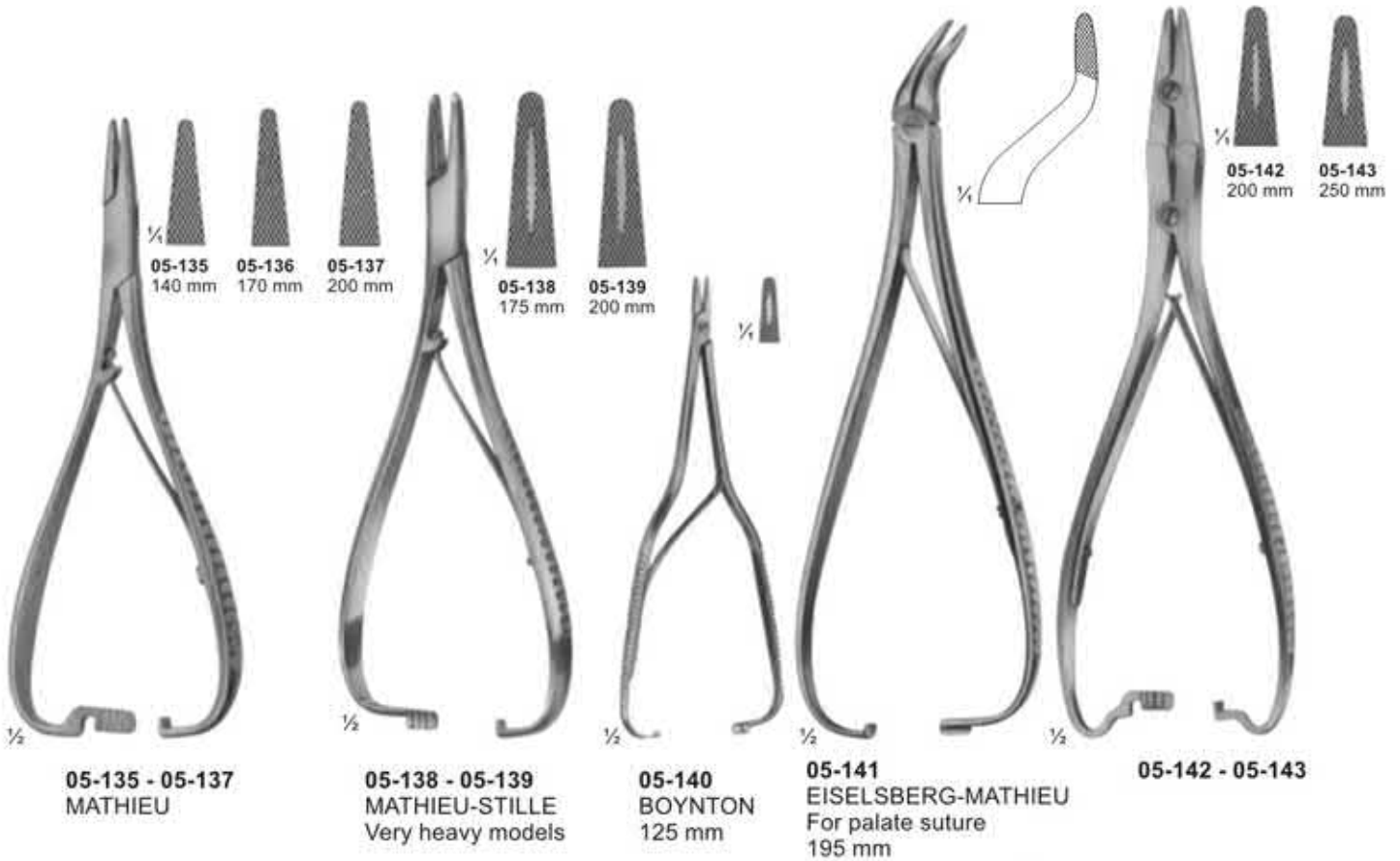

Suture Instruments - Reverdin Needles

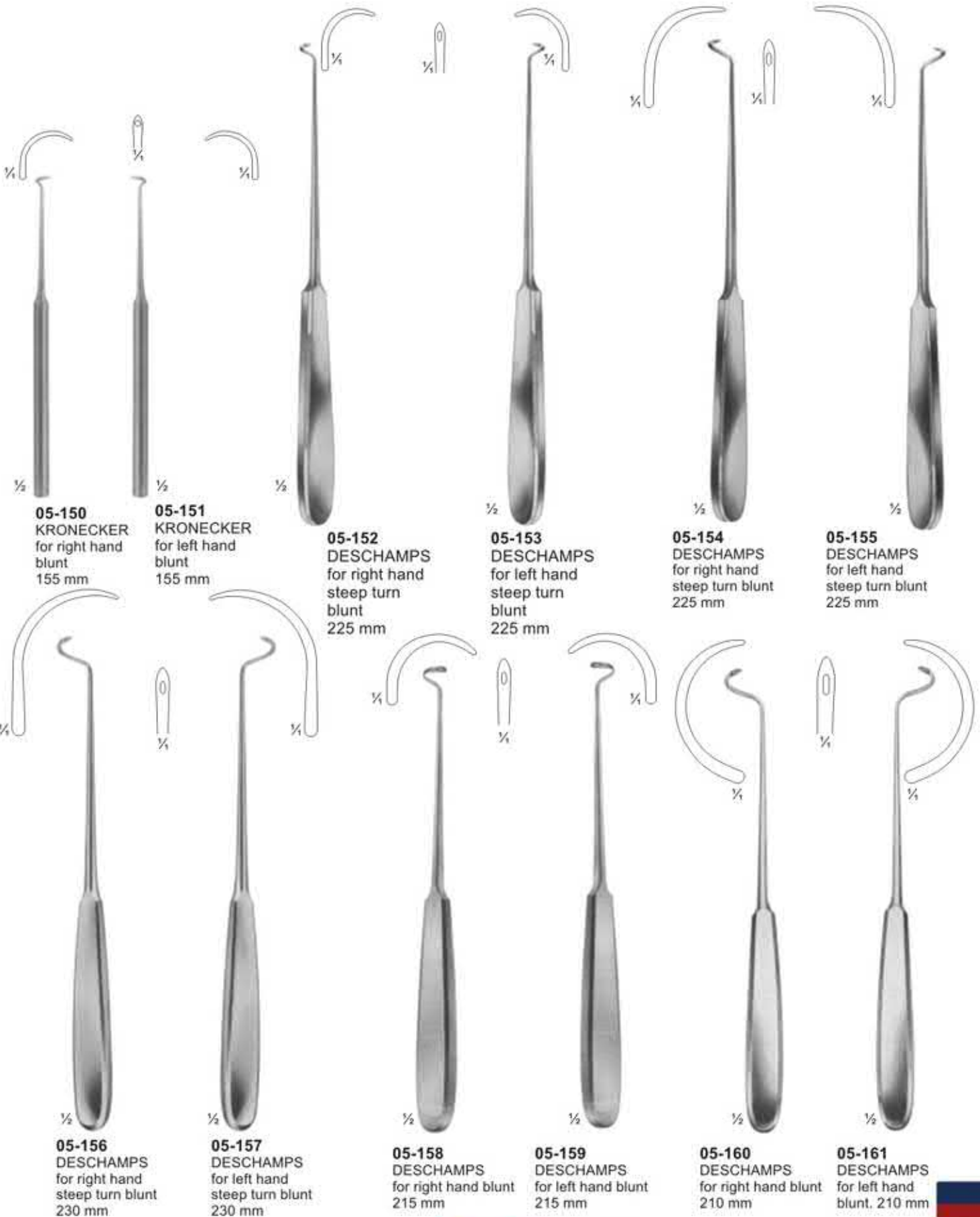

Probes



05-162 130 mm
05-163 145 mm
05-164 160 mm
 Directors



05-165
DOYEN
 145 mm
 Directors



05-166
NELATON
 160 mm
 Directors



05-167
 Director with tip
 Diam. of tip 3,3 mm
 140 mm



05-168
BRODIE
 Director with tip,
 Diam. of tip 3,5 mm
 200 mm



05-169
LOCKHART-MUMMERY
 165 mm



05-170
LOCKHART-MUMMERY
 165 mm

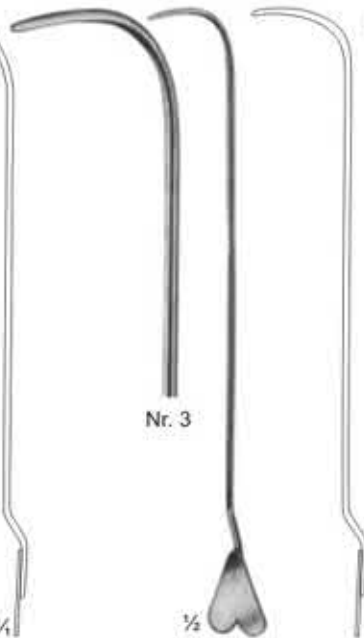

05-171
LOCKHART-MUMMERY
 165 mm

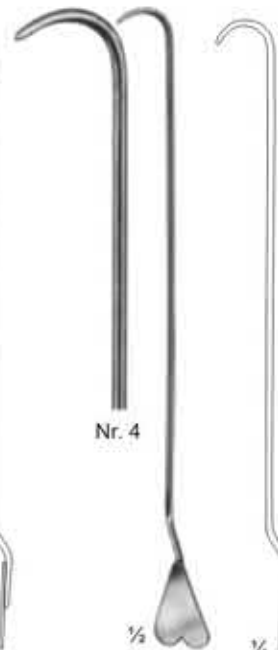

05-172
LOCKHART-MUMMERY
 165 mm



05-173
 Director with wire
 loop, malleable
 190 mm

Probes



05-174 145 mm
05-175 160 mm
05-176 200 mm
 Probes with eye



05-177
 Myrtle leaf probe
 145 mm



05-178 130 mm
05-179 145 mm
05-180 160 mm
05-181 180 mm
05-182 200 mm



05-183
 Probes



05-184 190 mm
 Double ended probe,
 malleable, diam. of tips
 3 mm with hole



05-185
 Double ended probes,
 tin, malleable,
 diam. of tips
 3,5 mm with hole
 250 mm, 300 mm



05-186 400 mm
 Double ended probes,
 tin, malleable,
 diam. of tips 4 mm



05-187 300 mm
05-188 300 mm
05-189 300 mm
 diam. of tip

Suturing Instrument Set, Pocket Instrument Set



05-190

Suturing instruments set, in metal case consisting of: Scissors, curved, sharp/sharp, 115mm
25 MICHEL clip, 16 x 3mm
1 Delicate tissue forceps, 130mm
1 Scalpel, bellied
1 MATHIEU needle holder, 140mm
1 Perforated metal case, stainless containing:
1 Suture needle
1 item 1 item



05-191

Pocket instrument set, in metal case consisting of:

Bottom tray

1 MATHIEU needle holder, 140mm
1 MICHEL clip forceps, combined
1 Myrtle leaf probe, 130mm
1 Sharp double curette
1 Skin hook
1 Detachable scalpel handle, no.4
1 Perforated metal case, containing
6 Scalpel blades
1 Perforated metal case, stainless, containing
1 Suture needle
1 item
1 item



Top tray

1 Tissue forceps, 130mm
1 KOCHER haemostatic forceps, 130mm
1 Straight surgical scissors, 130mm
1 Dissecting forceps, 130mm
1 FEILCHENFELD splinter forceps, 115mm
25 MICHEL clip, 16 x 3mm
1 Flacon of suture skin, sterile in alcohol



05-192

Pocket instrument set, in metal case consisting of:

Bottom tray

1 MAYO-HÉGER needle holder, 150mm
1 MICHEL clip forceps, combined
1 Myrtle leaf probe, 130mm
1 Sharp double curette
1 Skin hook
1 Detachable scalpel handle, no. 4
1 Perforated metal case, consisting
6 Scalpel blades
1 Perforated metal case, stainless, consisting:
1 Suture needle
1 item, & 1 item



Top tray

1 Tissue forceps, 130mm
1 CRILE haemostatic forceps, 140mm
1 Straight surgical scissors, 130mm
1 Dissecting forceps, 130mm
1 FEILCHENFELD splinter forceps, 115mm
25 MICHEL clip, 16 x 3mm
1 Flacon of suture silk, sterile in alcohol

Fine Wound Retractors (Dura- and Skin Retractors)

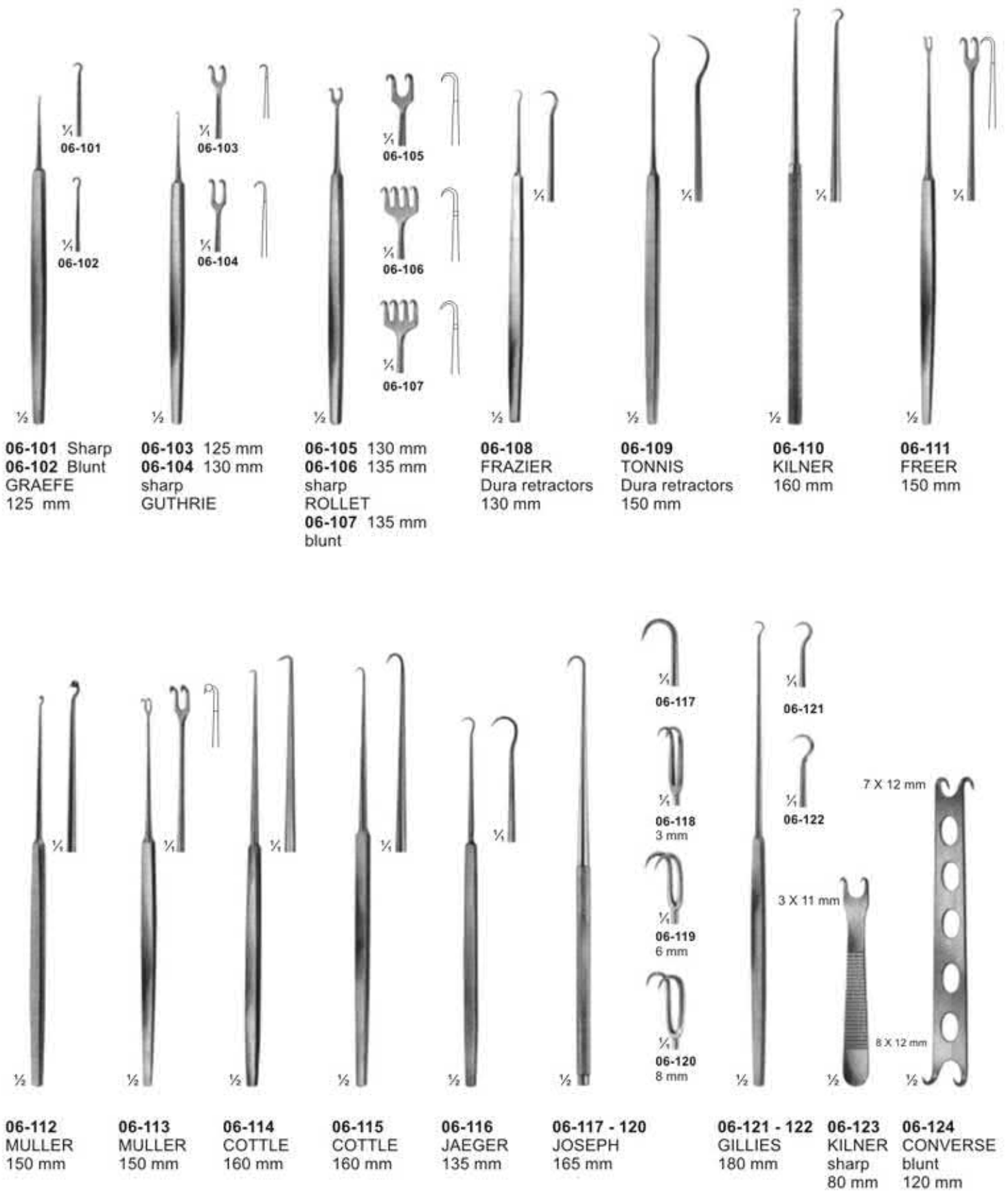

Retractors With treangle handle

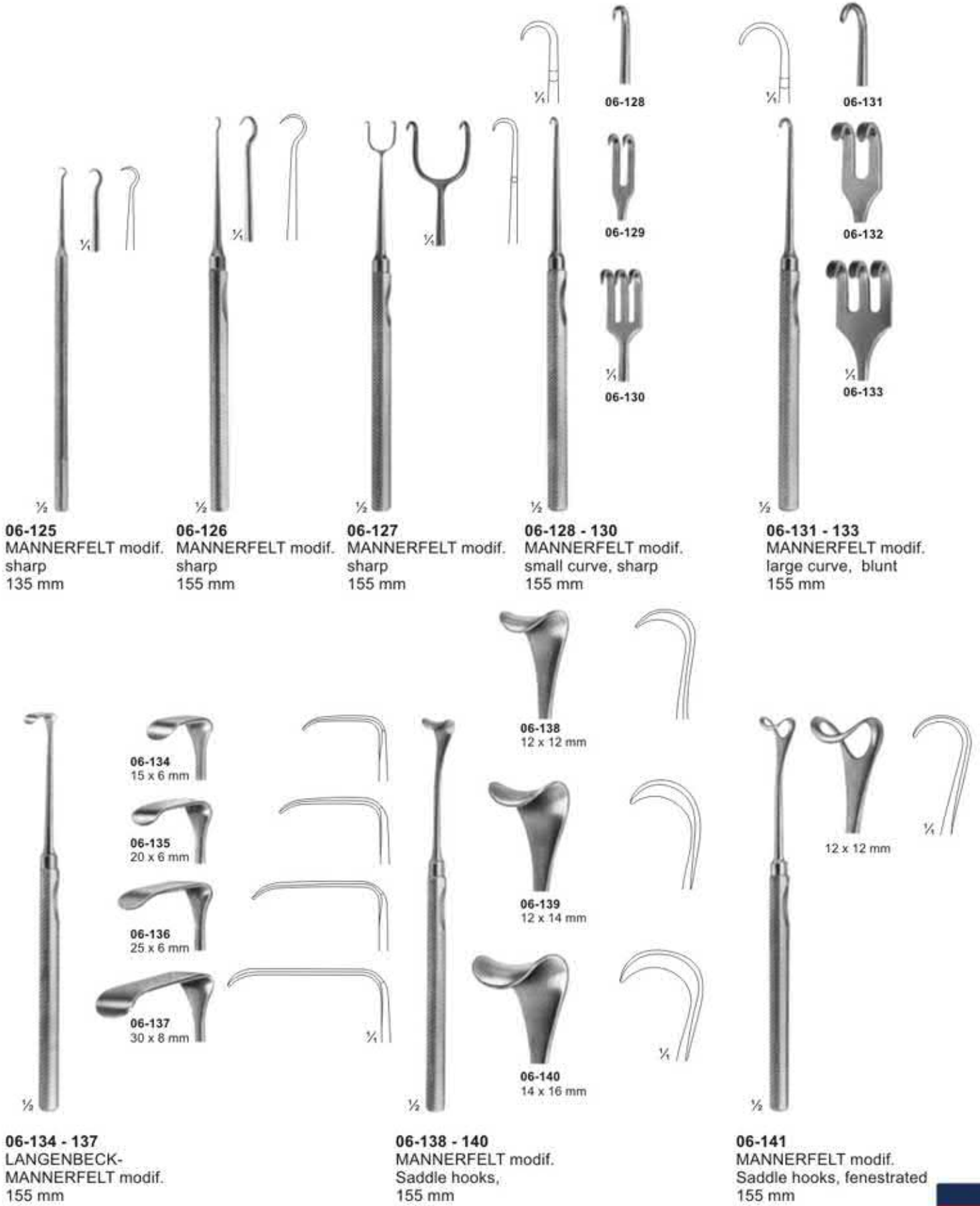

06-125
 MANNERFELT modif.
 sharp
 135 mm

06-126
 MANNERFELT modif.
 sharp
 155 mm

06-127
 MANNERFELT modif.
 sharp
 155 mm

06-128 - 130
 MANNERFELT modif.
 small curve, sharp
 155 mm

06-131 - 133
 MANNERFELT modif.
 large curve, blunt
 155 mm

06-134
 15 x 6 mm

06-135
 20 x 6 mm

06-136
 25 x 6 mm

06-137
 30 x 8 mm

06-138
 12 x 12 mm

06-139
 12 x 14 mm

06-140
 14 x 16 mm

12 x 12 mm

06-134 - 137
 LANGENBECK-
 MANNERFELT modif.
 155 mm

06-138 - 140
 MANNERFELT modif.
 Saddle hooks,
 155 mm

06-141
 MANNERFELT modif.
 Saddle hooks, fenestrated
 155 mm

Retractors



1/4
06-142
 MASING
 140 mm



1/4
06-143
 COTTLE
 140 mm



1/4
06-144 - 148
 DESMARRES
 140 mm



1/4
06-145
 9 x 12 mm



1/4
06-146
 11 x 14 mm



1/4
06-147
 12 x 16 mm



1/4
06-148
 13 x 18 mm



1/4
06-149
 13 x 13 mm



1/4
 10 x 10 mm



1/4
06-150
 12 x 16 mm

1/2
06-149 - 150
 KONIG
 180 mm

1/2
06-151
 CUSHING-KOCHER
 175 mm



1/4
06-152
 20 x 12 mm

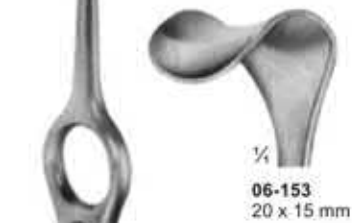

1/4
06-153
 20 x 15 mm

1/2
06-152 - 153
 KOCHER
 205 mm



1/4
 13 x 6 mm

1/2
06-154
 SCHOENBORN
 200 mm



1/4
06-155
 10 x 13 mm

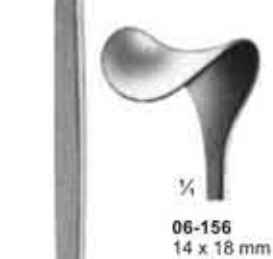

1/4
06-156
 14 x 18 mm

1/2
06-155 - 156
 CUSHING
 205 mm



1/2
06-157
 205 mm



1/4
06-158
 11 x 14 mm



1/4
06-159
 13 x 18 mm

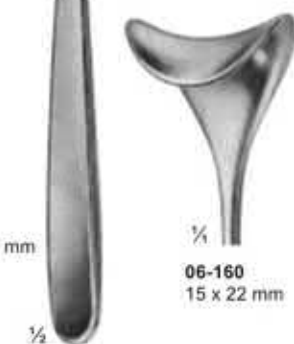

1/4
06-160
 15 x 22 mm

1/2
06-158 - 160
 CUSHING
 250 mm

Retractors



Retractors

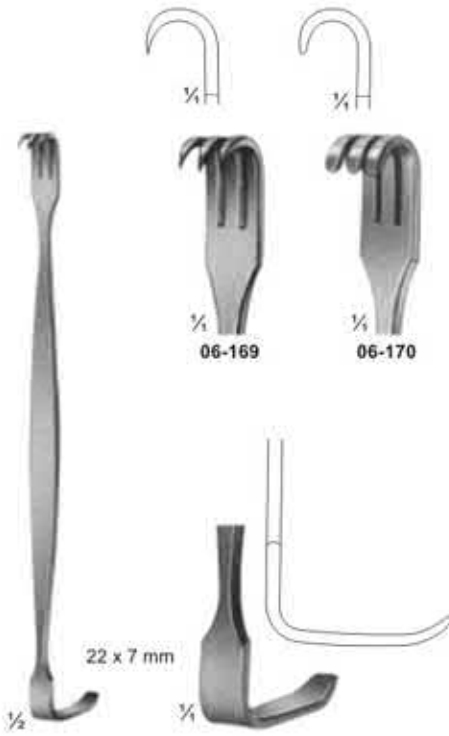

06-169 - 06-170
BABY-SENN-MILLER
 155 mm



06-171
SENN-MILLER
 165 mm



06-172
COLLIN-HARTMANN
 150 mm

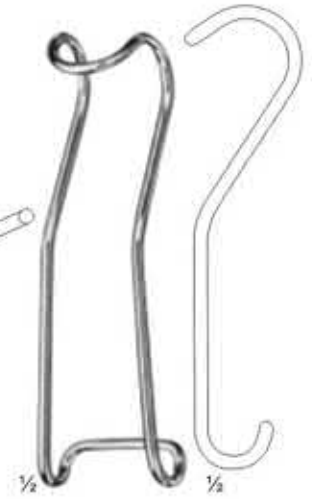

STERBERG
06-173 120 mm
06-174 130 mm
06-175 135 mm
06-176 140 mm



06-177
LUER
 110 mm

06-178
ROSE
 130 mm

06-179
BABY-ROUX
 135 mm



06-180
PARKER
 135 mm

06-181
CRILE
 110 mm



06-182
FARABEUF
 150 mm



06-183
COLLIN
 150 mm

Bone Retractors and Retractors



06-184
 KOCHER
 sharp
 205 mm



06-185
 KOCHER
 sharp
 220 mm



06-186
 KOCHER
 sharp
 220 mm



06-187
 VOLKMANN
 blunt
 220 mm



06-188
 VOLKMANN
 sharp
 220 mm



06-189 - 06-196
 VOLKMANN
 blunt
 225 mm

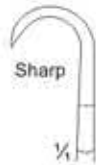

Sharp



06-189
 9 x 8 mm



06-190
 9 x 13 mm



06-191
 9 x 19 mm



06-192
 9 x 29 mm

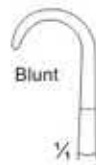

Blunt



06-193
 8,5 x 8 mm



06-194
 8,5 x 13 mm



06-195
 8,5 x 19 mm



06-196
 8,5 x 29 mm

Retractors



06-197
 15 x 15 mm
 220 mm

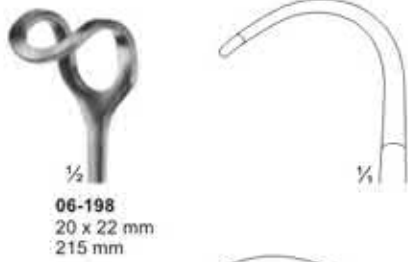

06-198
 20 x 22 mm
 215 mm



06-199
 28 x 28 mm
 235 mm

06-197 - 06-199
 MIDDELDORPF



38 x 18 mm

06-200
 BUCHS
 205 mm



67 x 17 mm

06-201
 CASPAR
 210 mm



36 x 20 mm

06-202
 KOCHER
 230 mm

Retractors, Vario Retractor System



- 06-203- 06-209**
BRUNNER
 275 mm
- 06-203** 80 x 20
 - 06-204** 100 x 25
 - 06-205** 120 x 25
 - 06-206** 130 x 30
 - 06-207** 140 x 30
 - 06-208** 160 x 30
 - 06-209** 180 x 30



Retractors, Lung Spatulas



**Retractors for deep surgery
(Abdominal Retractors)**

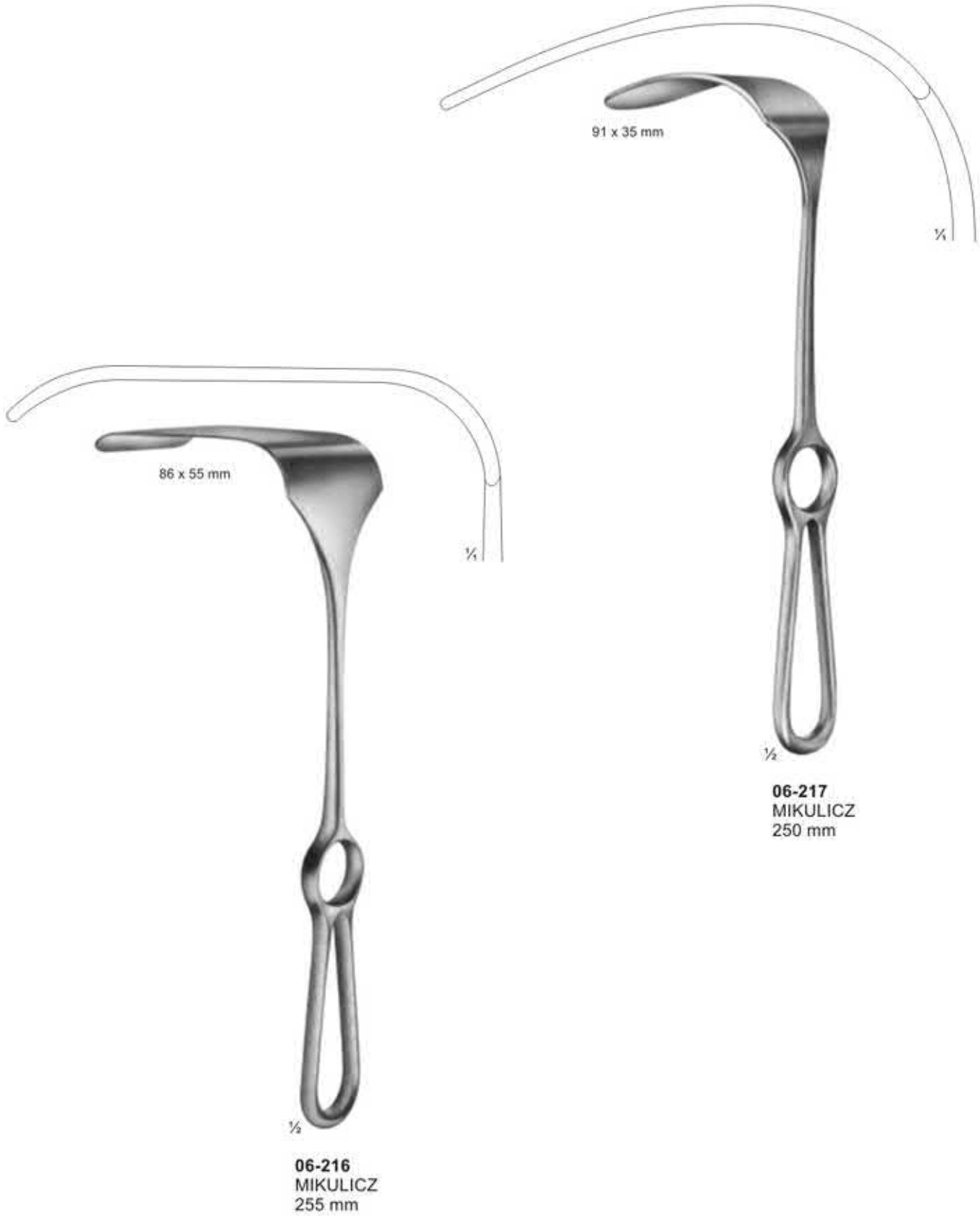

Retractors, Abdominal Retractors

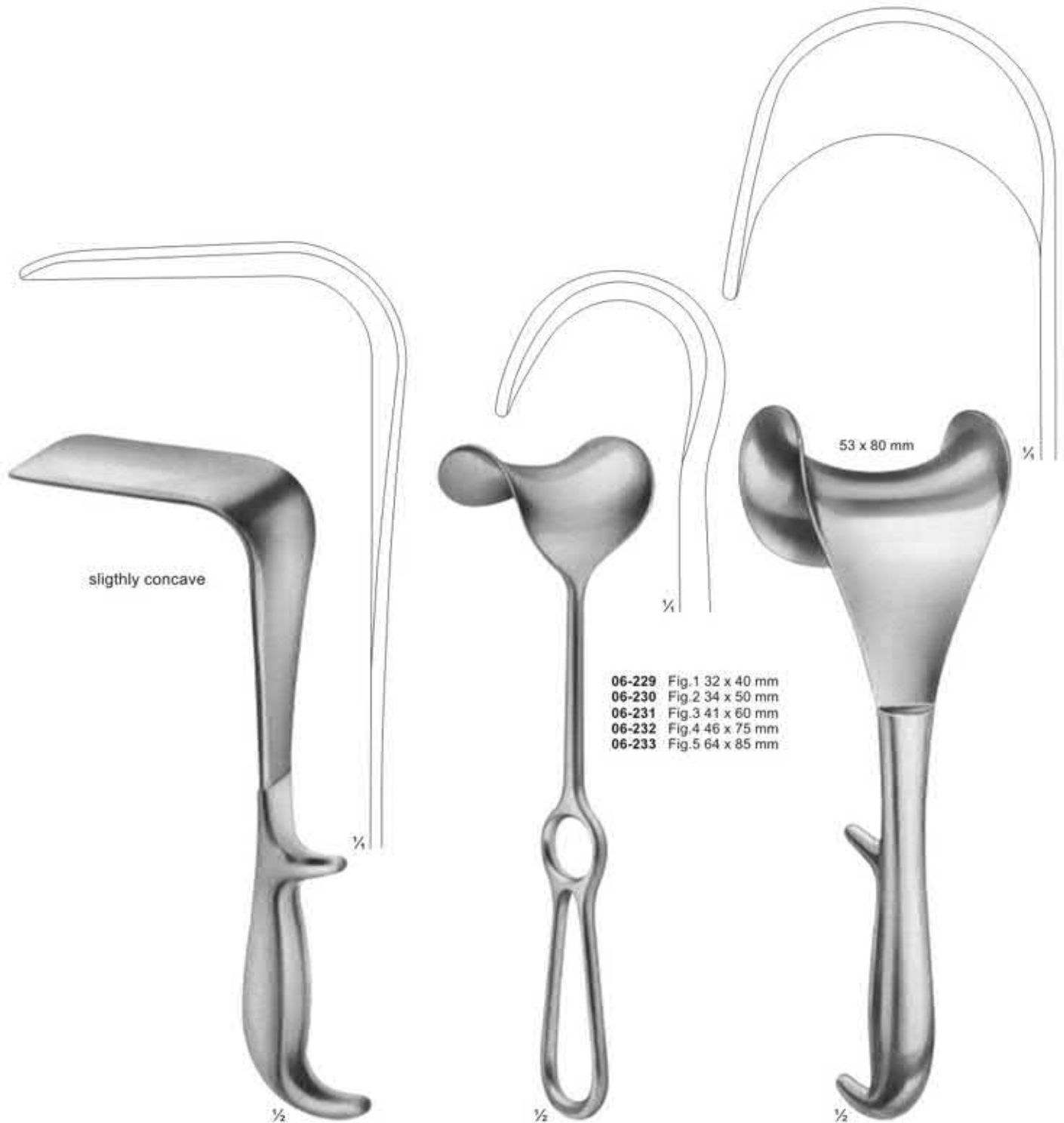

- 06-229 Fig.1 32 x 40 mm
- 06-230 Fig.2 34 x 50 mm
- 06-231 Fig.3 41 x 60 mm
- 06-232 Fig.4 46 x 75 mm
- 06-233 Fig.5 64 x 85 mm

06-218 - 06-228
 DOYEN
 240 mm

06-229 - 06-233
 FRITSCH
 240 mm

06-234
 DOYEN
 250 mm

	width of blades	35 mm, 45 mm, 60 mm
length of blades		
62 mm	06-218 , 06-222 , 06-226	
92 mm	06-219 , 06-223 , 06-227	
122 mm	06-220 , 06-224 , 06-228	
160 mm	06-221 , 06-225	

Abdominal- and Intestinal Spatulas
Bauch- und Darmspatel



06-235
LERICHE
 255 mm

06-236
KUMMEL
 Mealleable
 285 mm

06-237
MIKULICZ
 29 mm
 250 mm

06-238 - 06-239
KADER
06-238 30 mm
06-239 40 mm
 270 mm

Self-Retaining Retractors

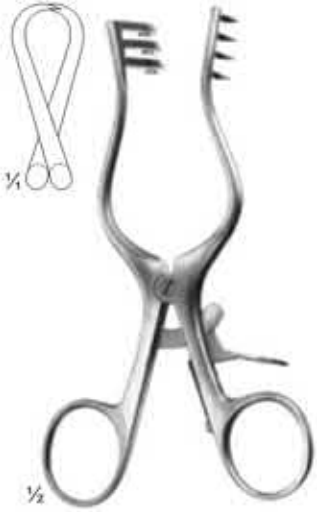

06-240
WEITLANER
 sharp
 130 mm

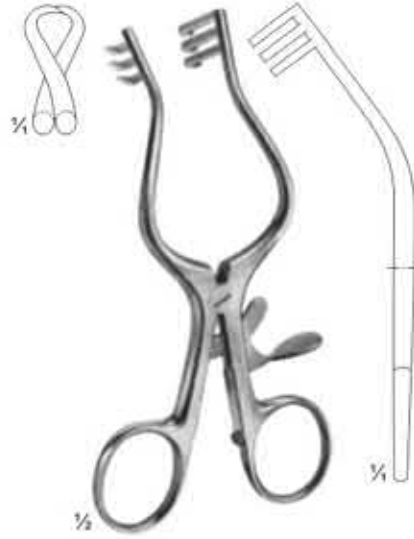

06-241
WULLSTEIN
 sharp
 130 mm

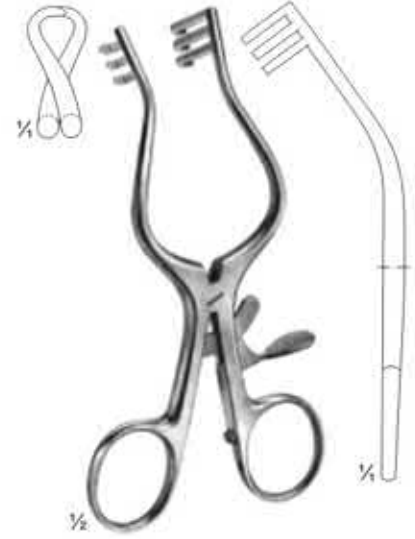

06-242
WULLSTEIN
 blunt
 130 mm



06-243
WEITLANER
 sharp
 165 mm



06-244
PLESTER
 blunt
 110 mm



06-245
PERKINS
 blunt
 130 mm

Special Retractors



06-246
JOLL (FRIEDMAN)
 Thyroid- and vaginal retractor
 155 mm



06-247
JACKSON BURROWS
 Retractor, blunt
 185 mm

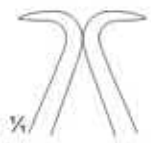

06-248
GELPI
 Vaginal retractor
 135 mm

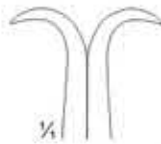

06-249
GELPI
 Skin- and vaginal retractor
 175 mm

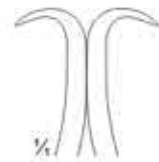

06-250
DE BAKEY
 Femur retractor
 145 mm

Lamina Spreaders



06-251
CLOWARD
 155 mm



06-252
CLOWARD
 135 mm



06-253
INGE
 170 mm

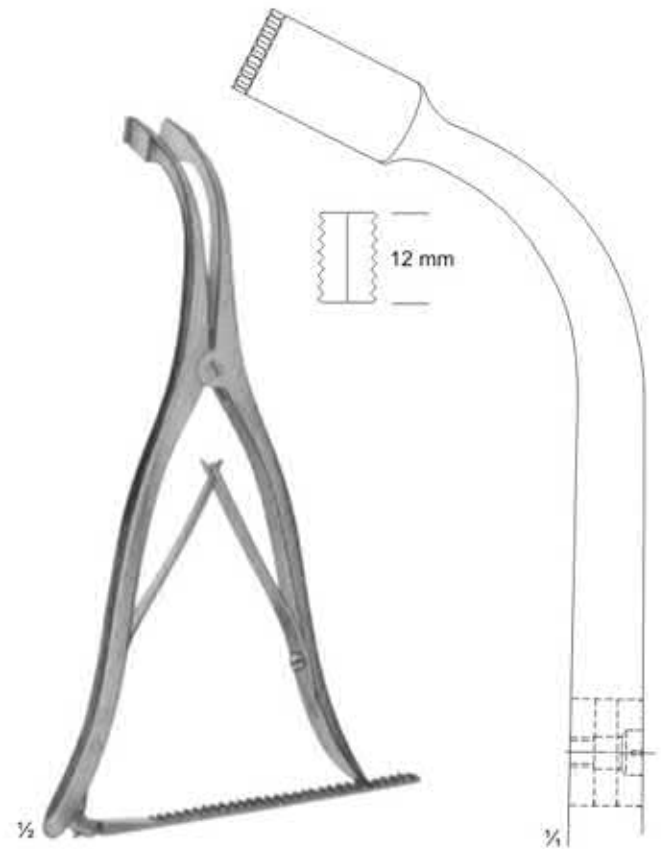

06-254
INGE
 275 mm

Abdominal Retractors



06-255
GOSSET
 Blades: 38 mm deep



06-256
HERTZLER
 Blades 20 X 25 mm

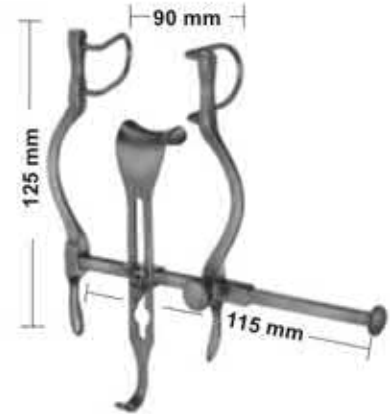

06-257
BALFOUR-BABY
 Lateral blades 27 mm deep
 Center blade 21x24 mm

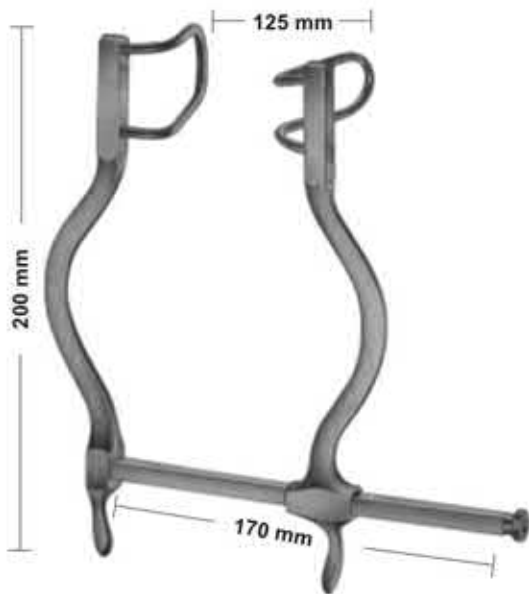

06-258
GOSSET
 Blades: 55 mm deep

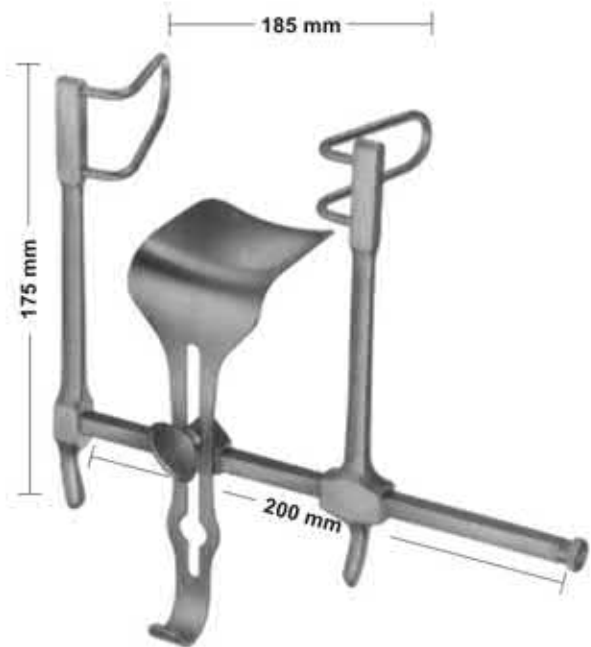

06-259
GOSSET
 Lateral blades 58 mm deep
 Center blade 59 x 57 mm

Abdominal Retractors

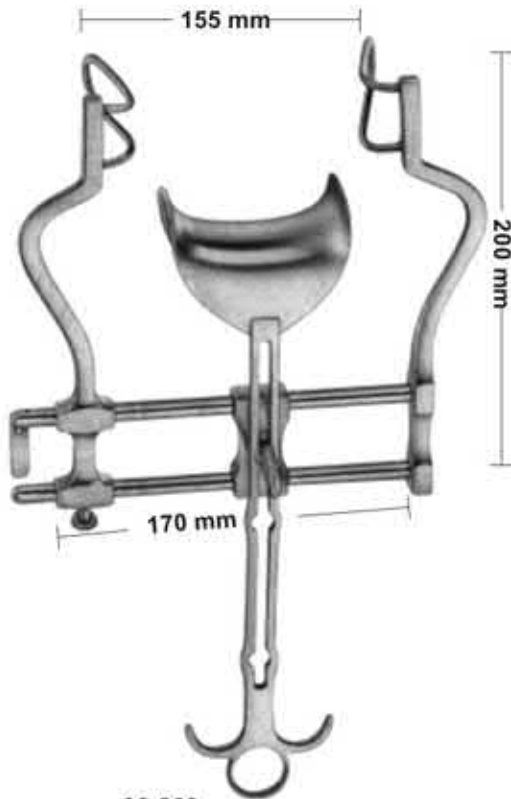

06-260
BALFOUR
 Lateral blades 60 mm deep
 Center blade 47 x 80 mm

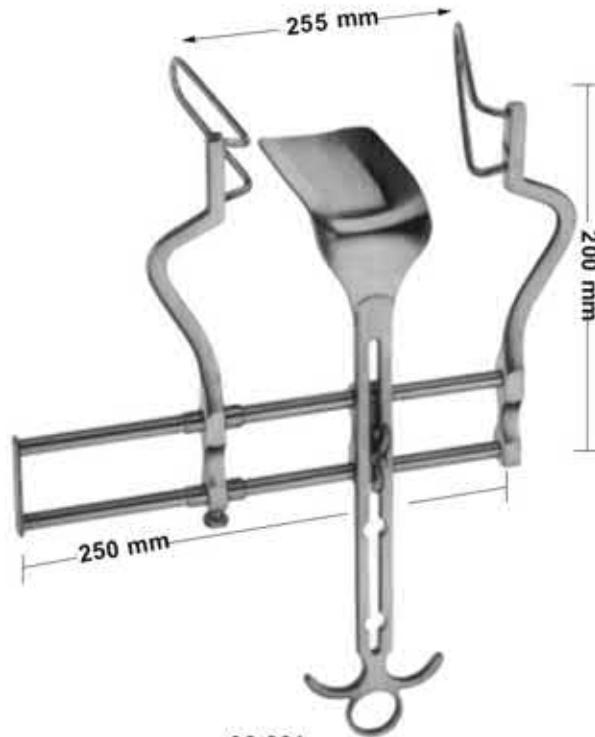

06-261
BALFOUR
 Lateral blades 105 mm deep
 Center blade 107x 59 mm



06-262
 Center blade only
 54x80 mm

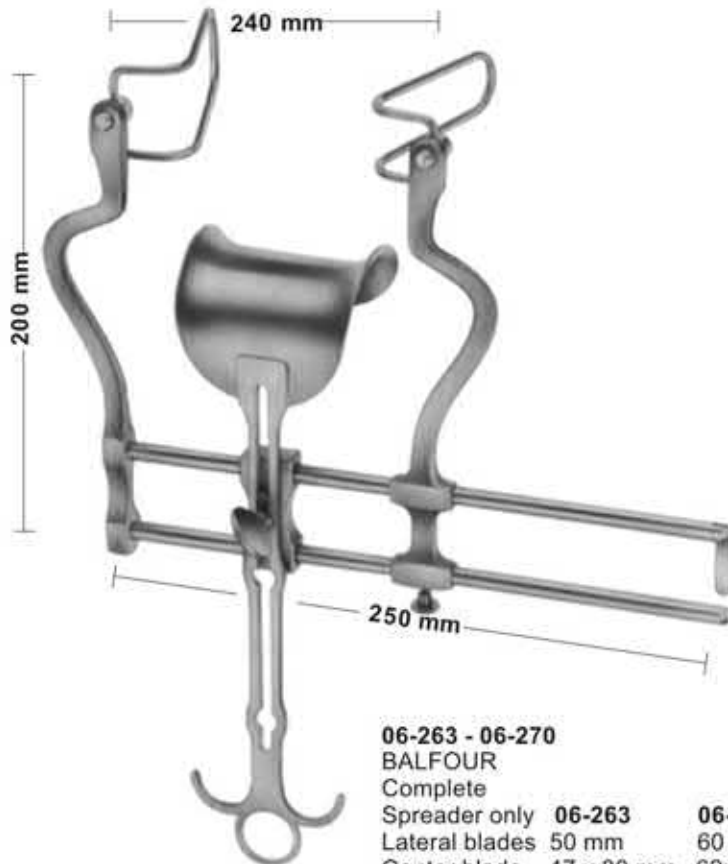

06-263 - 06-270
BALFOUR
 Complete

Spreader only	06-263	06-264	06-265	06-266
Lateral blades	50 mm	60 mm	75 mm	90 mm
Center blade	47 x 80 mm	62x76 mm	80x80 mm	80x80 mm



Lateral blades
06-267 50 mm deep
06-268 60 mm deep
06-269 75 mm deep
06-270 90 mm deep
 Sales Unit of blades: PR = pair

Organ-, Tissue and Intestinal Grasping Forceps

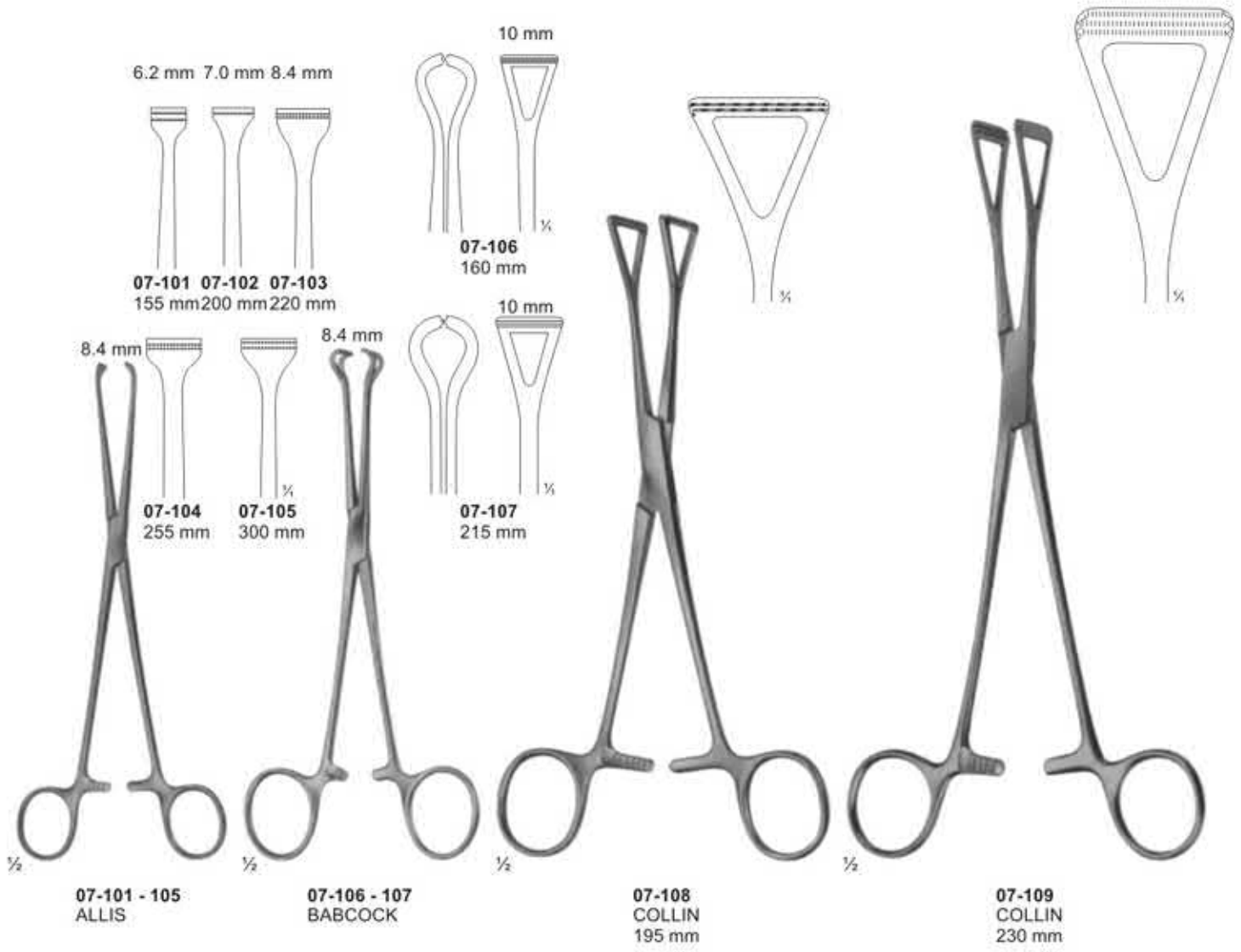

Intestinal Clamps, soft elastic

ATRAUMATA

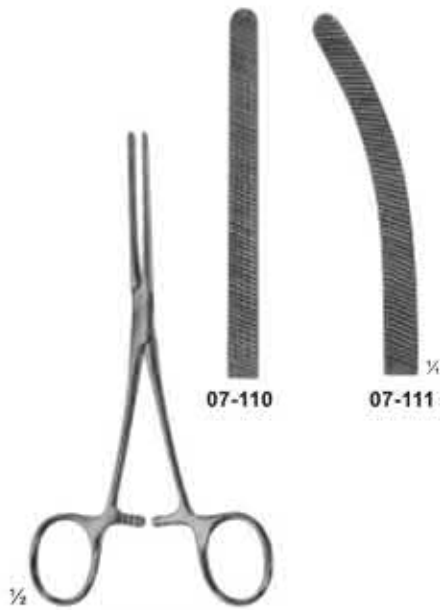

07-110 - 111
DOYEN
 elastic
 165 mm

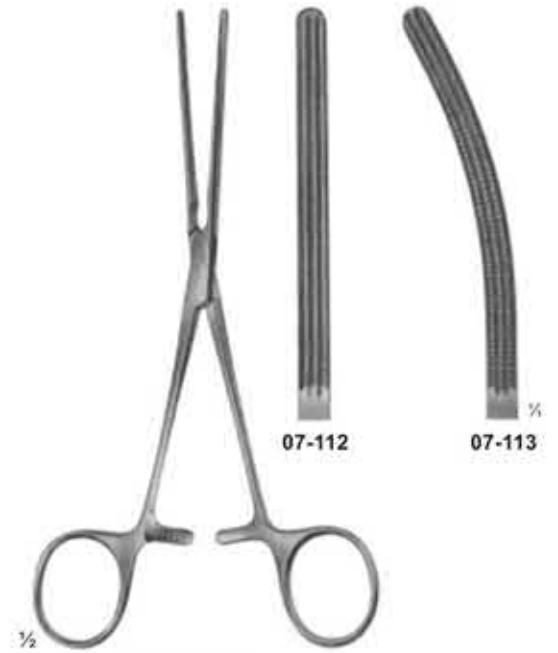

07-112 - 113
DOYEN
 with elastic blades
 170 mm

ATRAUMATA

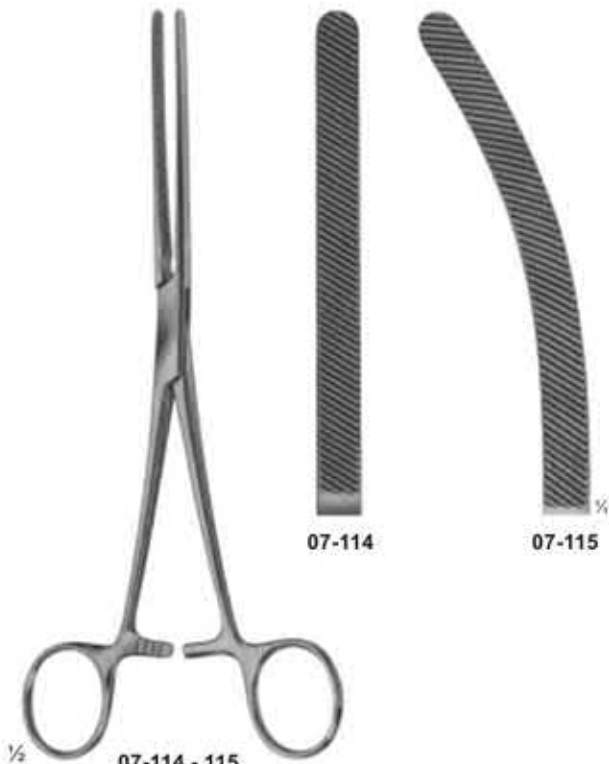

07-114 - 115
HARTMANN
 with elastic blades
 200 mm



07-116 - 117
HARTMANN
 with elastic blades
 200 mm

Intestinal and Pylorus Clamps



07-118
 PAYR
 Intestinal clamp
 light pattern,
 for children
 180 mm

07-119
 PAYR
 200 mm

07-120
 PAYR
 275 mm

07-121
 PAYR
 Pylorus clamp
 315 mm

ATRAUMATA
Sigmoid Anastomosis Forceps

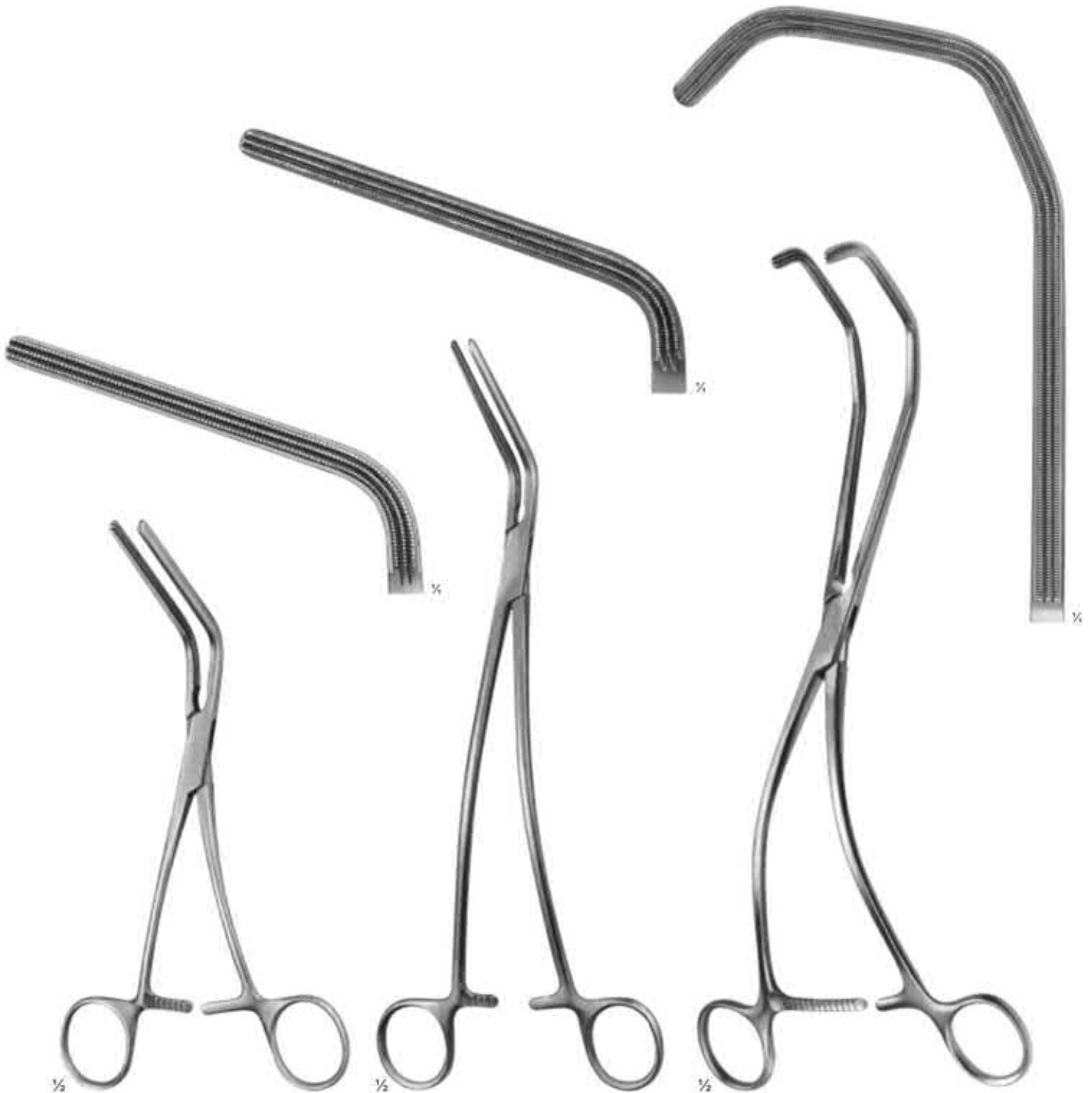

07-122
MORRIS
175 mm

07-123
DE BAKEY
(MORRIS modif.)
240 mm

07-124
KERSTING
270 mm

Nasal Specula



08-101
 Martin
 13 cm / 5 1/8"



08-102
 SIMS
 160 mm



08-103
 Tieck-Halle
 13 cm / 5 1/8"



08-104
 Killian

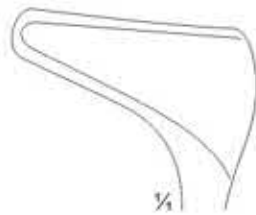

Fig. 1
 14 cm 5 4/8"
 35 mm

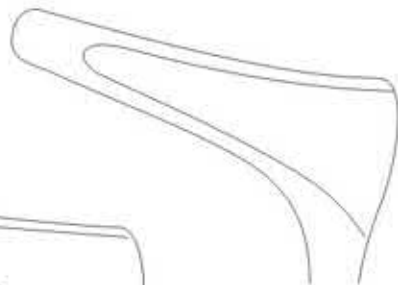

Fig. 2
 14,5 cm / 5 4/8"
 50 mm

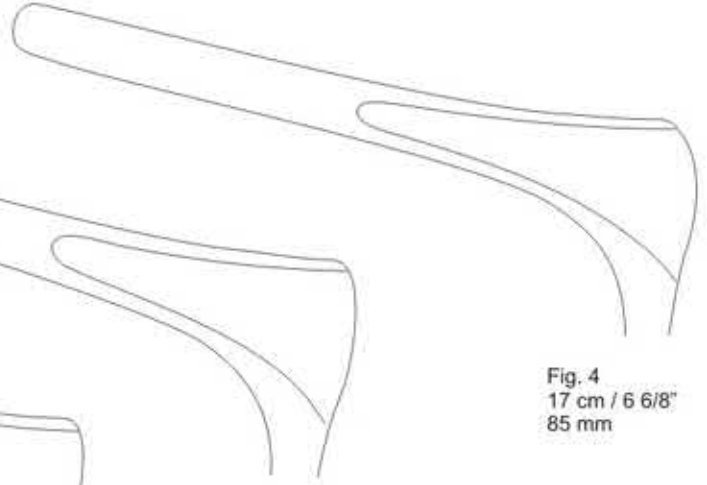

Fig. 3
 16 cm / 6 2/8"
 75 mm

Fig. 4
 17 cm / 6 6/8"
 85 mm

Anuscopy-Sphincteroscopes



08-109
 IVES-FANSLER
 Anuscopy
 145 mm
 Ø24mm



08-110
 KELLY
 Sphincteroscope
 160 mm
 Ø21mm



08-111
 KELLY
 Sphincteroscope
 160 mm
 Ø27mm

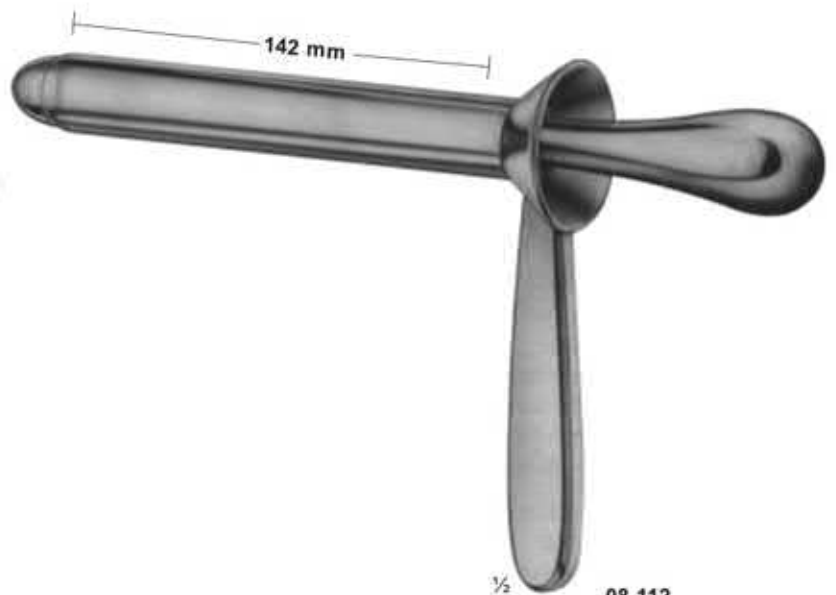

08-112
 KELLY
 Proctoscope
 140 mm
 Ø22mm

Haemorrhoidal Forceps

ATRAUMATA

Pressure Clamp

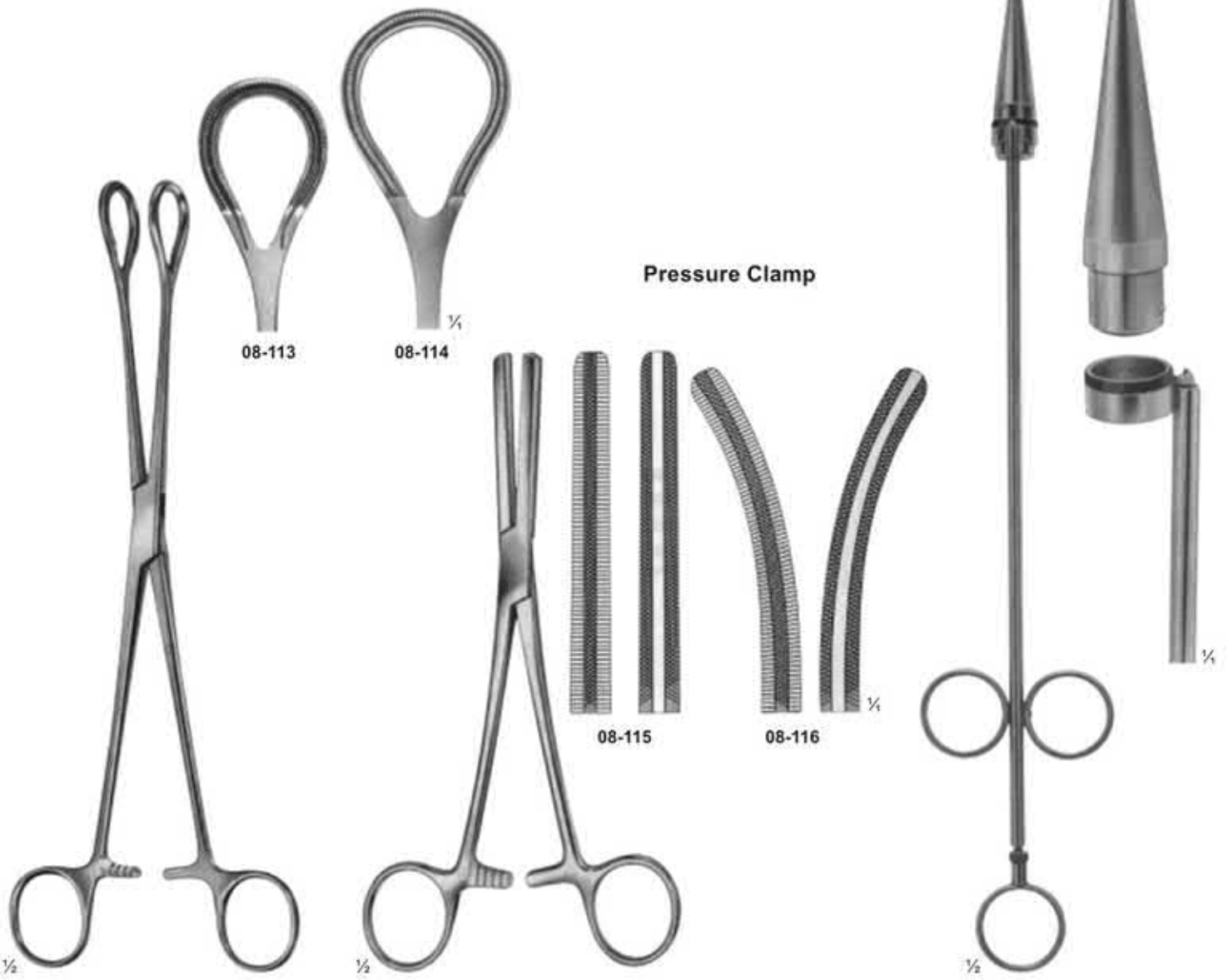

08-113 - 08-114
 250 mm
 270 mm

08-115 - 08-116
 FERGUSSON
 200 mm

08-117
 RUDD
 Haemorrhoidal ligator
 with loading
 attachment and 100
 ligature rubber rings
 315 mm

Gall Duct Forceps



08-118
 LOWER
 180 mm



08-119
 LAHEY (SWEET)
 190 mm



08-120
 LAHEY
 220 mm



08-121
 DESJARDINS
 Gall duct-and cystic forceps
 210 mm



08-122
 NISSEN
 Gall duct-and cystic forceps
 215 mm

Gall Duct Dilators and Gall Stone Scoops

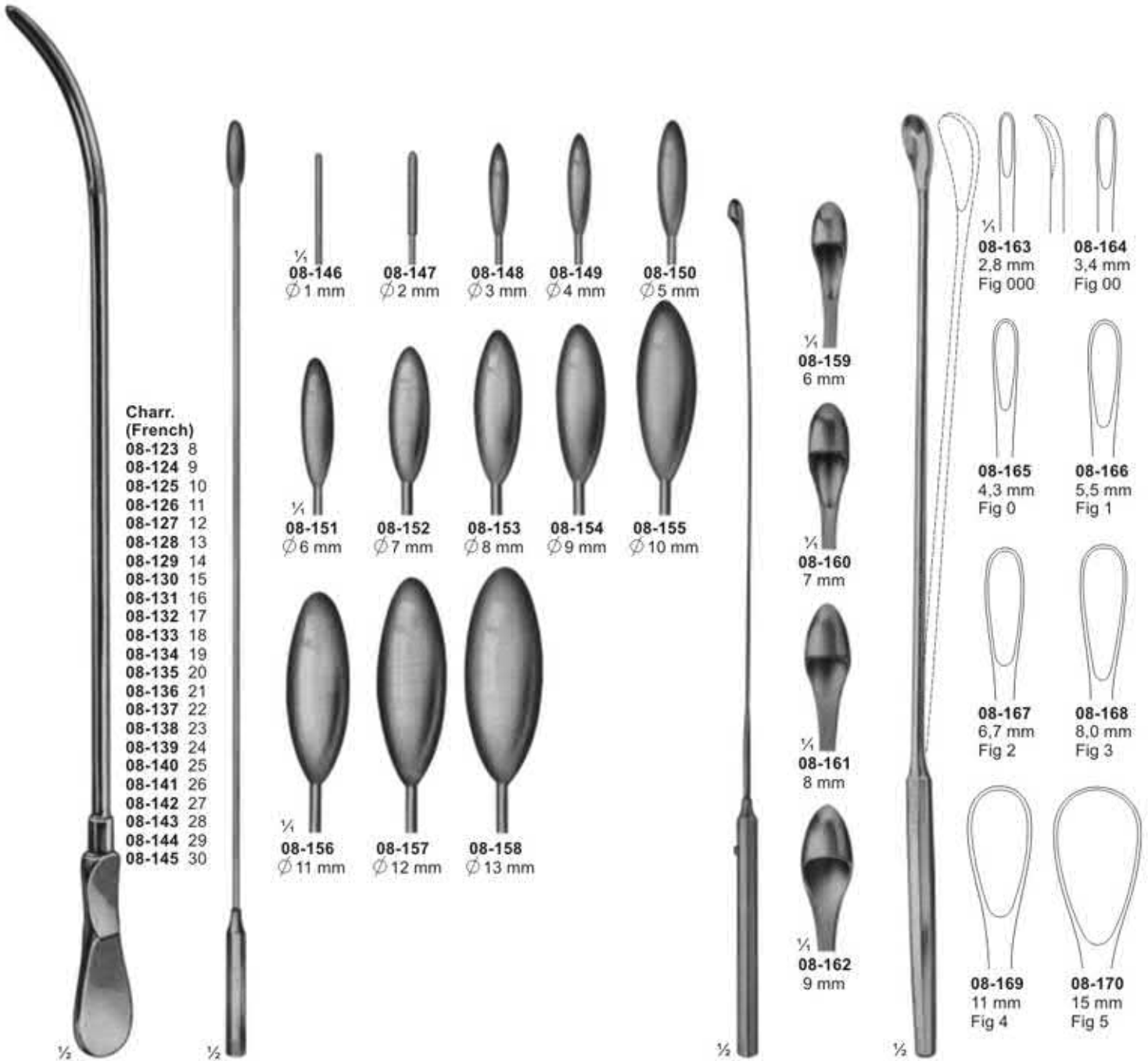

**Charr.
(French)**
08-123 8
08-124 9
08-125 10
08-126 11
08-127 12
08-128 13
08-129 14
08-130 15
08-131 16
08-132 17
08-133 18
08-134 19
08-135 20
08-136 21
08-137 22
08-138 23
08-139 24
08-140 25
08-141 26
08-142 27
08-143 28
08-144 29
08-145 30

1/4
08-146
Ø 1 mm

08-147
Ø 2 mm

08-148
Ø 3 mm

08-149
Ø 4 mm

08-150
Ø 5 mm

1/4
08-151
Ø 6 mm

08-152
Ø 7 mm

08-153
Ø 8 mm

08-154
Ø 9 mm

08-155
Ø 10 mm

1/4
08-156
Ø 11 mm

08-157
Ø 12 mm

08-158
Ø 13 mm

1/4
08-159
6 mm

1/4
08-160
7 mm

1/4
08-161
8 mm

1/4
08-162
9 mm

1/4
08-163
2,8 mm
Fig 000

08-164
3,4 mm
Fig 00

08-165
4,3 mm
Fig 0

08-166
5,5 mm
Fig 1

08-167
6,7 mm
Fig 2

08-168
8,0 mm
Fig 3

08-169
11 mm
Fig 4

08-170
15 mm
Fig 5

08-123 - 08-145
DITTEL
Metall bougies and
dilating sounds, stiff
345 mm

08-146 - 08-158
BAKES
Common bile duct
dilators, malleable
08-146 - 08-150 315 mm
08-151 - 08-158 320 mm

08-159 - 08-162
DESJARDINS
Probe and catch
with flexible schaft
300 mm

08-163 - 08-170
LUER-KOERTE modif
with malleable shaft
310 mm

Gall Stone Forceps

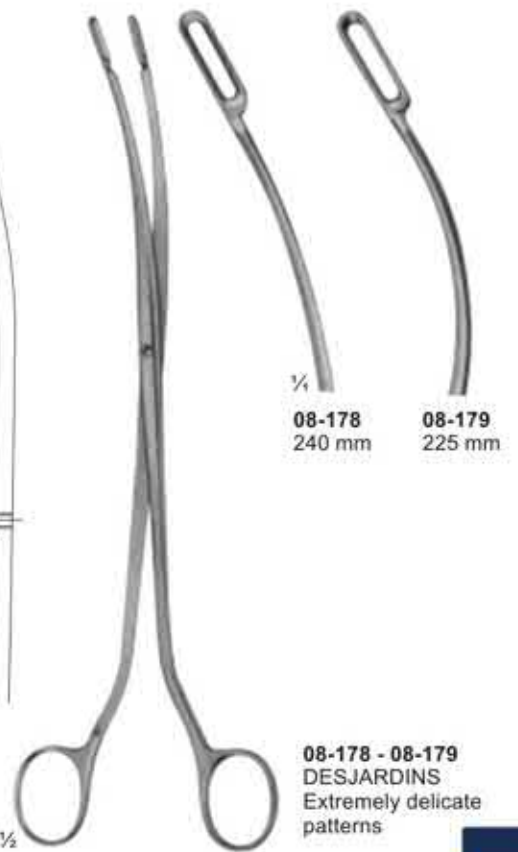
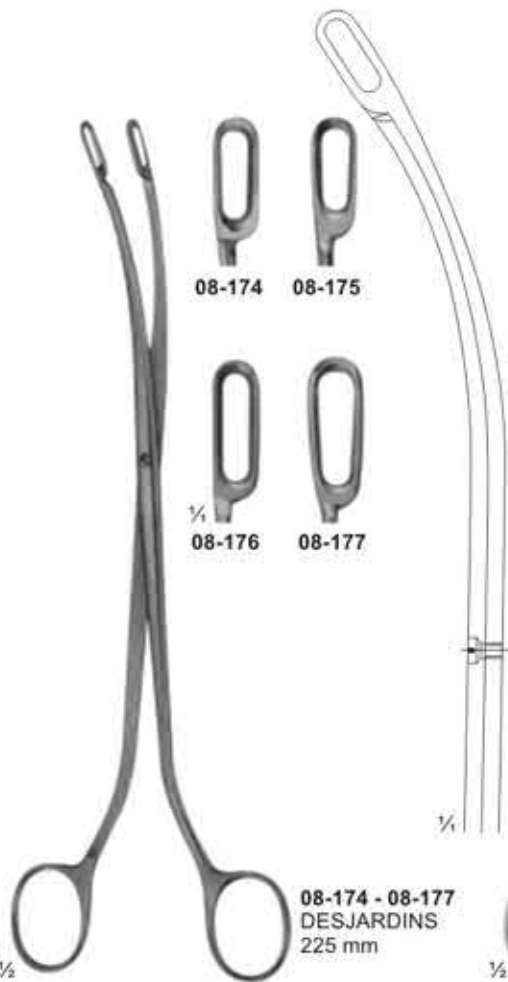
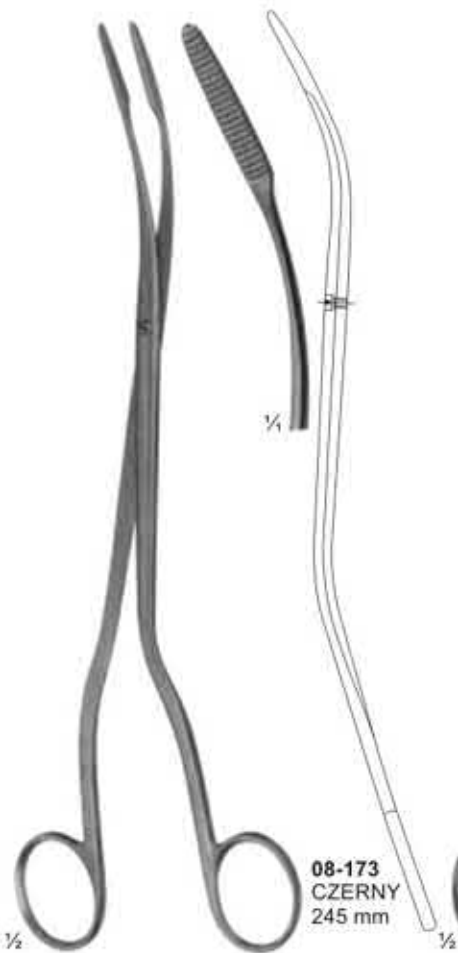

Kidney Clamps

ATRAUMATA

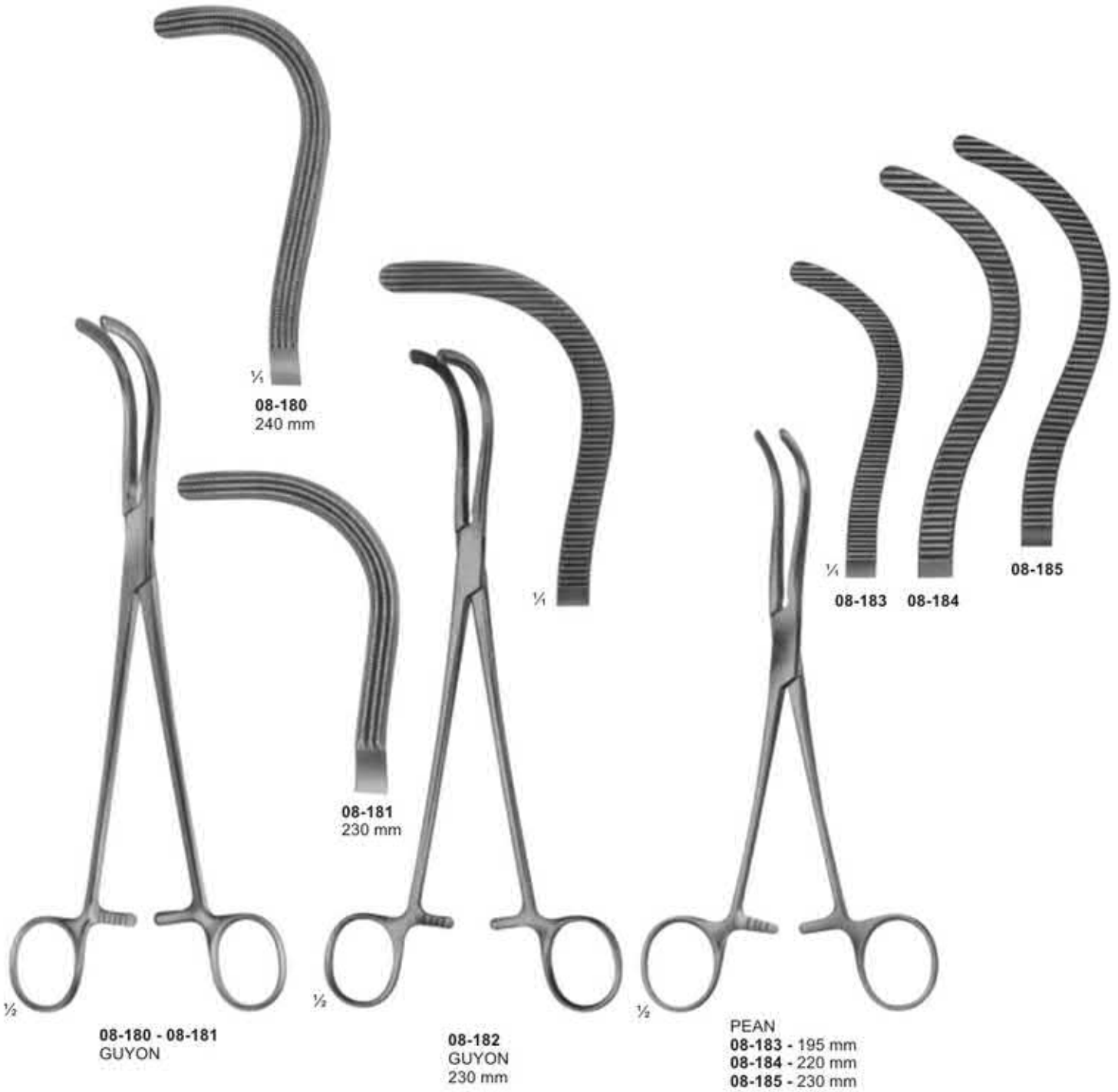

Kidney Stone Forceps



08-186



08-187



08-188



1/4
08-189



08-190



08-191



1/4
08-192



1/2

08-186 - 08-189
 RANDALL
 225 mm



1/2

08-190 - 08-192
 RANDALL
 190 mm

Bladder Retractors

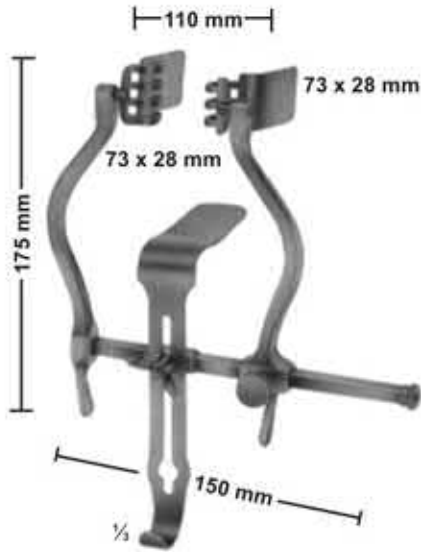

09-101
JUDD-MASSON
 Bladder-and suprapubic retractor

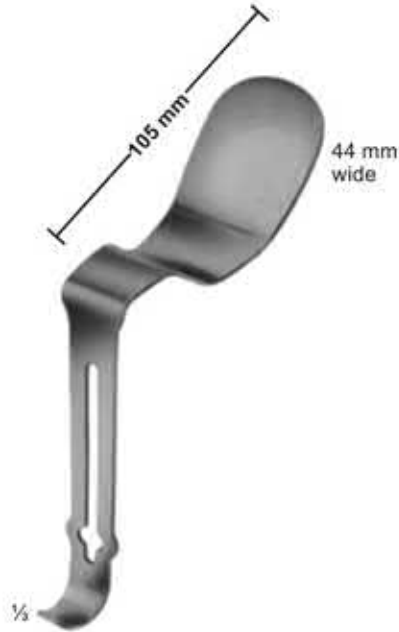

09-102
MILLIN
 Center bladder for retro pubic prostatectomy



09-103
MILLIN
 Bladder retractor, complete
 105X45 mm



09-104
LEGUEU
 Bladder retractor
 Center blade
 80 x 31 mm



09-105
KOCHER
 Bladder spatula
 235 mm

Trocars



09-106
KLIMA ROSEGGER
35 X 1,8 mm
Sternal puncture needle

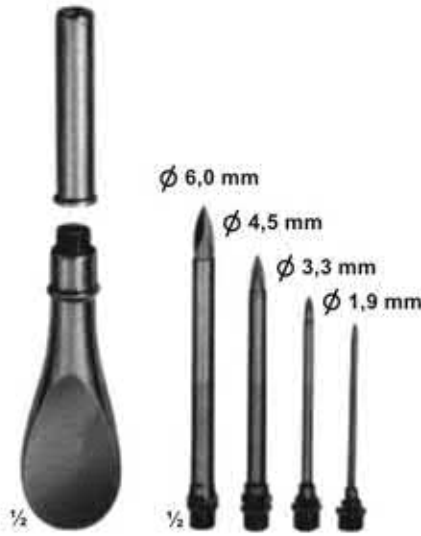

09-107
Universal trocar
with 4 tips



NELSON



09-108 - 112
Inside diam. Outside diam
09-108 2,2 mm 3,0 mm
09-109 3,0 mm 4,0 mm
09-110 4,0 mm 5,0 mm
09-111 5,0 mm 6,0 mm
09-112 5,5 mm 6,5 mm
 for hydrocele and abdominal puncture

09-113 - 116
Inside dime. Outside dime
09-113 2,2 mm 3,0 mm
09-114 3,0 mm 4,0 mm
09-115 4,0 mm 5,0 mm
09-116 5,0 mm 6,0 mm
 for abdominal puncture,
 with stop-cock and lateral
 drain



09-117 - 118
Inside diam. Outside diam
09-117 6,5 mm 8,0 mm
09-118 9,0 mm 10,0 mm
 Empyema trocar
 BUELEU



09-119 - 122
Inside diam. Outside diam
09-119 3,0 mm 4,0 mm
09-120 3,6 mm 4,6 mm
09-121 4,3 mm 5,3 mm
09-122 5,0 mm 6,0 mm
 Gall bladder trocars. OCHSNER



09-123
PIERCE
Antrum trocar
 ϕ 4,0 mm



09-124
COAKLEY
Antrum trocar
3,0 mm

Vaginal Specula



10-101
 COLLIN
 for children
 53 x 10 mm

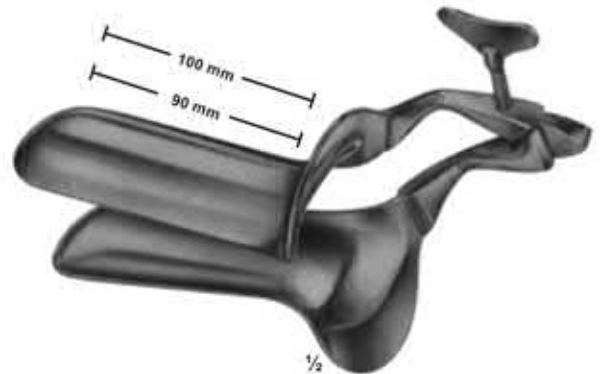

10-102 - 105
 COLLIN

10-102	100/90mm	28 mm
10-103	100/90mm	32 mm
10-104	105/95mm	35 mm
10-105	115/105mm	40 mm

Total length/working length width



10-106
 COLLIN
 for virgins
 95/85 x 18 mm



10-107
 CUSCO
 for virgins
 75 x 17 mm



10-108
 CUSCO
 for virgins
 75 x 17 mm



Swiss patterns
 features: long and narrow

10-109 - 111
 CUSCO

10-109	92X23-25 mm
10-110	100x25-27 mm
10-111	110x27-30 mm

Vaginal Specula- Sets, upper and lower blades



10-112 - 114
GRAVE
 10-112 75X20 mm
 10-113 95X30 mm
 10-114 105X33 mm

1/2



10-115 - 116
PEDERSON
 10-115 100X22 mm
 10-116 120X25 mm

1/2



10-117 - 118
BRIESKY
 10-117 72X25 mm / 77X30 mm 140 mm
 10-118 75X30 mm / 92X38 mm 170 mm

1/2



10-119
SIMS
 70 X 26 mm / 75 X 30 mm
 75 X 30 mm / 80 X 35 mm
 80 X 36 mm / 90 X 40 mm
 175 mm

1/2



10-120 - 122
SEIDL
 10-120 80X8 mm
 10-121 80X10 mm
 10-122 90X14 mm
 For children and infants
 170 mm

1/2



10-123
KRISTELLER
 70X15 mm, (170 mm)
 For children

1/2



10-124 - 10-126
KRISTELLER
 10-124 70X27 mm
 10-125 75X30 mm
 10-126 90X36 mm
 175 mm

1/2

Vaginal Specula- upper and lower blades



10-127 - 131
 KRISTELLER
 10-127 110X18 mm
 10-128 110X20 mm
 10-129 110X27 mm
 10-130 110X30 mm
 10-131 110X36 mm
 220 mm

10-132 - 10-135
 KRISTELLER
 Upper blades

10-136 - 10-139
 KRISTELLER
 Lower blades

Vaginal Specula



Vaginal Retractors



10-154
JOLL (FRIEDMAN)
 155 mm



10-155
RICHTER
 170 mm



10-156
GELPI
 135 mm



10-157
GELPI
 175 mm

Uterine Dilators



11-101	1	mm	11-123	23	mm
11-102	2	mm	11-124	24	mm
11-103	3	mm	11-125	25	mm
11-104	4	mm	11-126	26	mm
11-105	5	mm	11-127	1	1/2mm
11-106	6	mm	11-128	2	1/2mm
11-107	7	mm	11-129	3	1/2mm
11-108	8	mm	11-130	4	1/2mm
11-109	9	mm	11-131	5	1/2mm
11-110	10	mm	11-132	6	1/2mm
11-111	11	mm	11-133	7	1/2mm
11-112	12	mm	11-134	8	1/2mm
11-113	13	mm	11-135	9	1/2mm
11-114	14	mm	11-136	10	1/2mm
11-115	15	mm	11-137	11	1/2mm
11-116	16	mm	11-138	12	1/2mm
11-117	17	mm	11-139	13	1/2mm
11-118	18	mm	11-140	14	1/2mm
11-119	19	mm	11-141	15	1/2mm
11-120	20	mm	11-142	16	1/2mm
11-121	21	mm	11-143	17	1/2mm
11-122	22	mm			

11-101 - 143
 HEGAR
 with very conical point
 185 mm



11-144	1+2	mm
11-145	3+4	mm
11-146	5+6	mm
11-147	7+8	mm
11-148	9+10	mm
11-149	11+12	mm
11-150	13+14	mm
11-151	15+16	mm
11-152	17+18	mm

11-144 - 152
 HEGAR
 205 mm



11-153
 HEGAR
 Uterine dilator set, in canvas
 roll with 8 dilators.

Uterine Probes

5 mm



11-154
 MAYO
 malleable
 330 mm

4 mm



11-155
 SIMS
 malleable
 330 mm

3 mm



11-156
 MARTIN
 330 mm

4 mm



11-157
 SIMPSON
 malleable
 silver-plated
 290 mm



24 mm

11-158
 BRAUN
 Uterine
 depressor
 270 mm



11-159
 Cotton
 applicator
 270 mm

Uterine Dressing Forceps



11-160
PELKMANN
260 mm



11-161
PELKMANN
260 mm



11-162
BOZEMANN
250 mm



11-163
BOZEMANN
255 mm

Jaws with longitudinal groove

Polypus-and Ovum Forceps

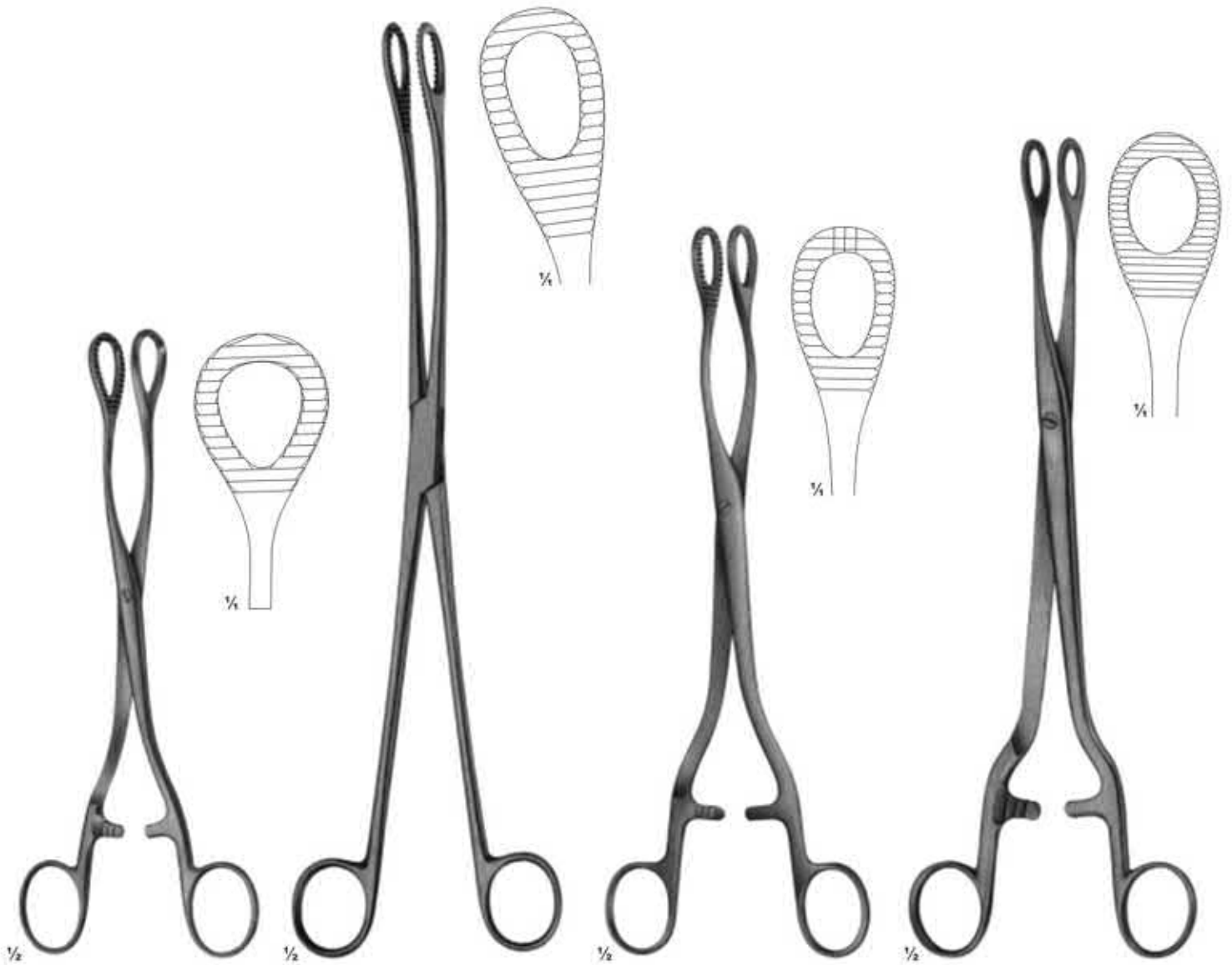

$\frac{1}{4}$
11-164
HEYWOOD-SMITH
200 mm

$\frac{1}{4}$
11-165
KELLY
320 mm

$\frac{1}{4}$
11-166
HEYWOOD-SMITH
250 mm

$\frac{1}{4}$
11-167
NOTO
280 mm

Ear Curettes



12-101
 Langenbeck
 13 cm / 5 1/8"



12-102
 Shapleigh
 15 cm / 5 1/8"

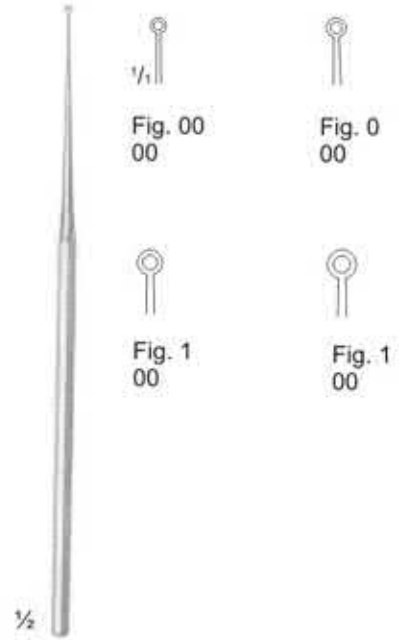

12-103
 Buck
 17cm / 6 6/8"



12-104
 Buck
 15 cm / 6 6/8"

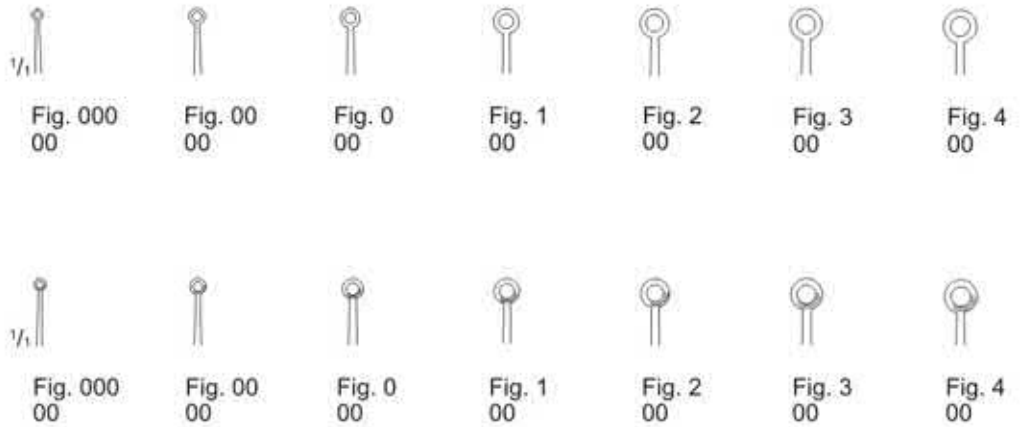

Biopsy Curettes



Ear Polypus Forceps



12-109
 Hartmann-Wullstein
 shaft length
 85 mm



12-110
 Hartmann-Wullstein
 shaft length
 85 mm



12-111
 Hartmann
 shaft length
 85 mm



12-112
 Hartmann
 shaft length
 85 mm

12-113
 14 cm / 5 4/8"
 shaft length
 140 mm



12-109 - 12-119



12-114
 Hartmann-Herzfel
 2,0 mm
 shaft length
 85mm



12-115
 Hartmann
 3 mm
 shaft length
 85mm



12-116
 shaft length
 85mm

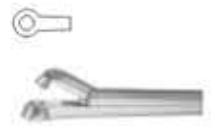

12-117
 Hartmann-Hoffmar
 2,0 mm
 85mm

12-118
 2,5 mm
 85 mm

12-119
 3,0 mm
 85 mm

Biopsy forceps for rectum

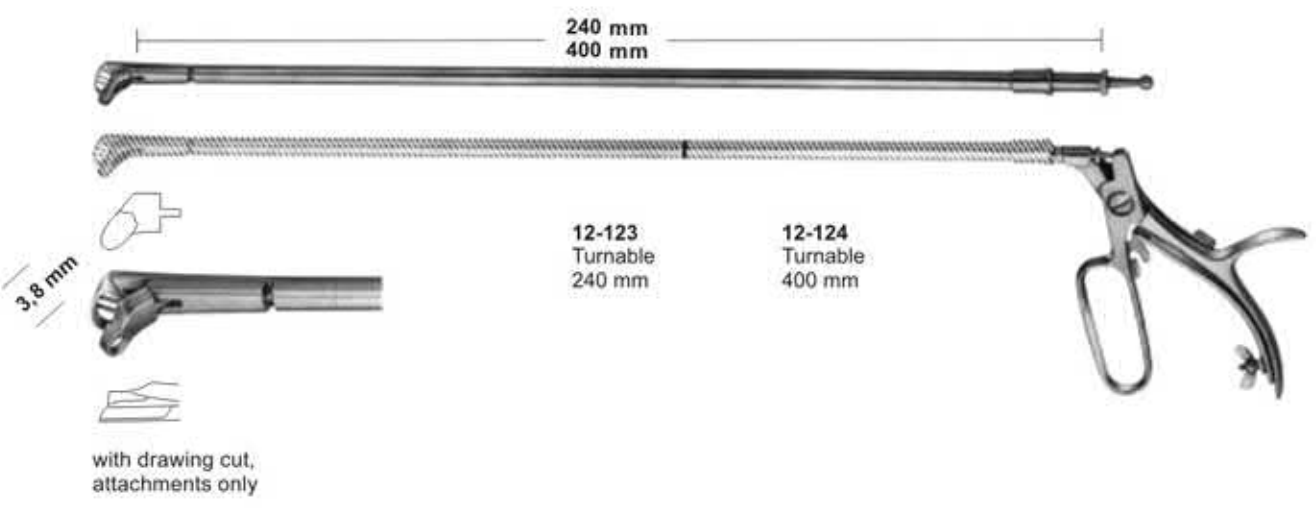
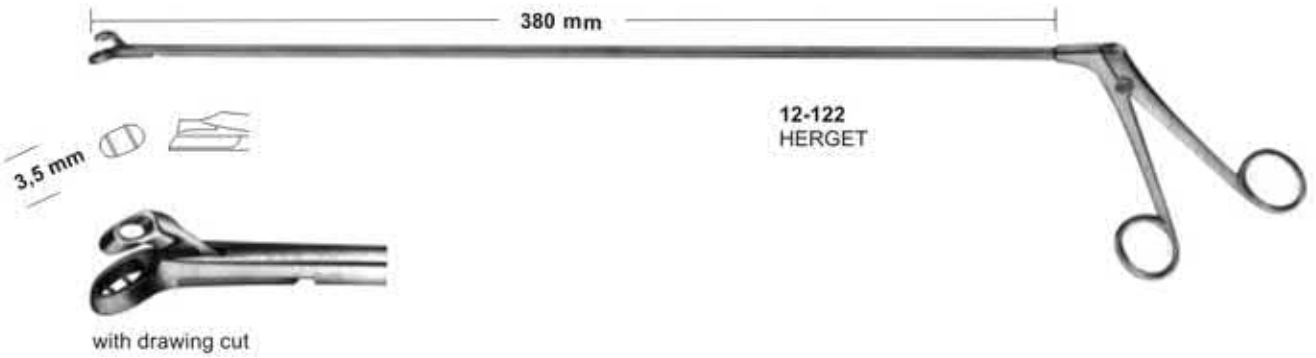
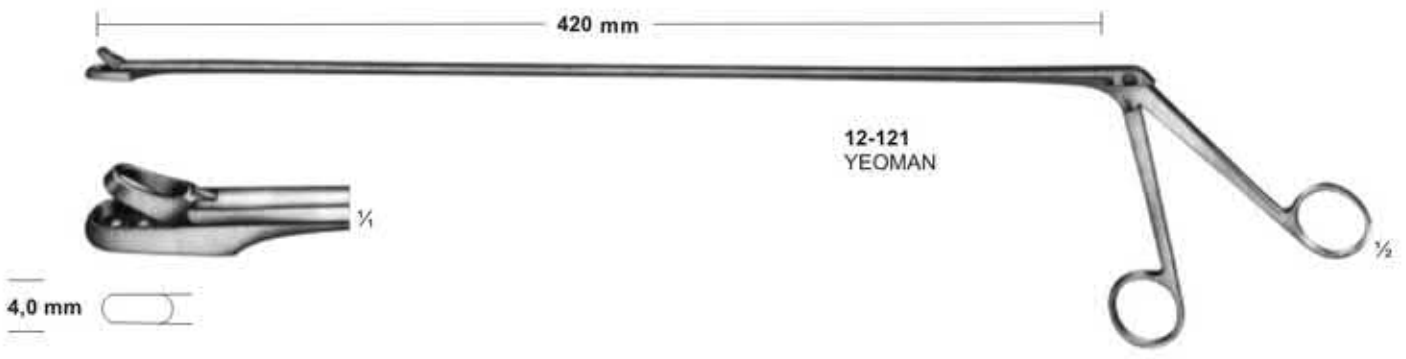
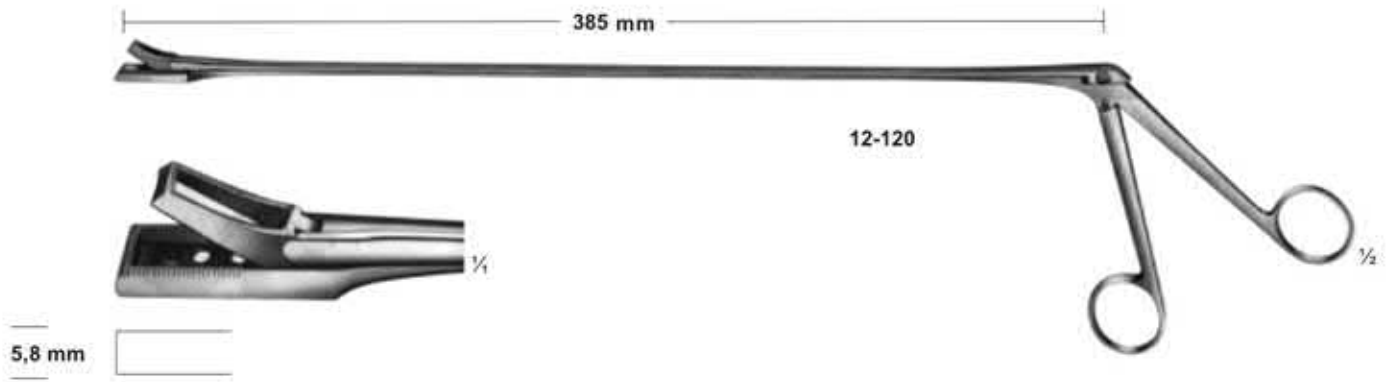

Biopsy Forceps

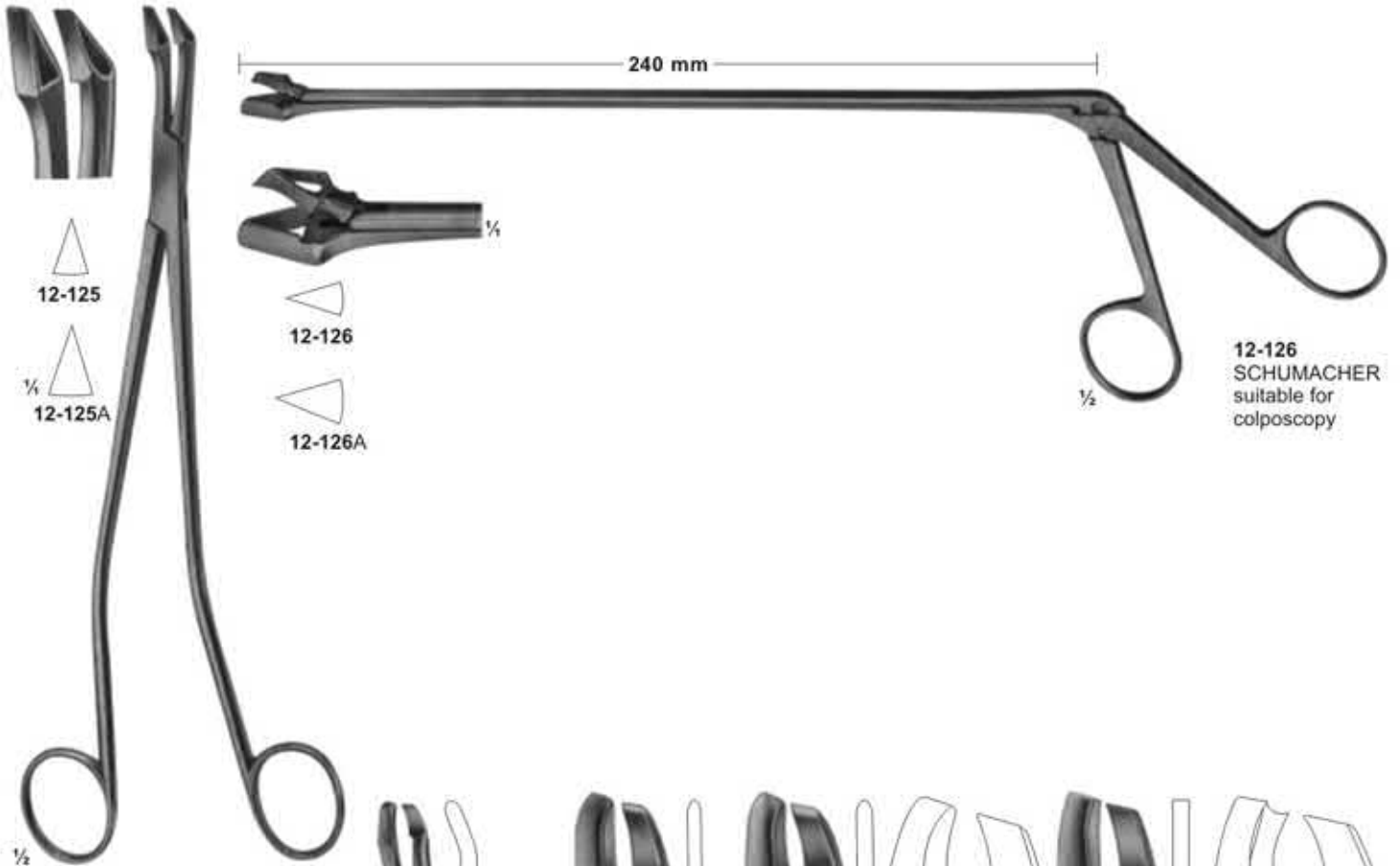

12-125

12-125A

12-126

12-126A

12-126
 SCHUMACHER
 suitable for
 colposcopy

12-125
 SCHUMACHER
 240mm

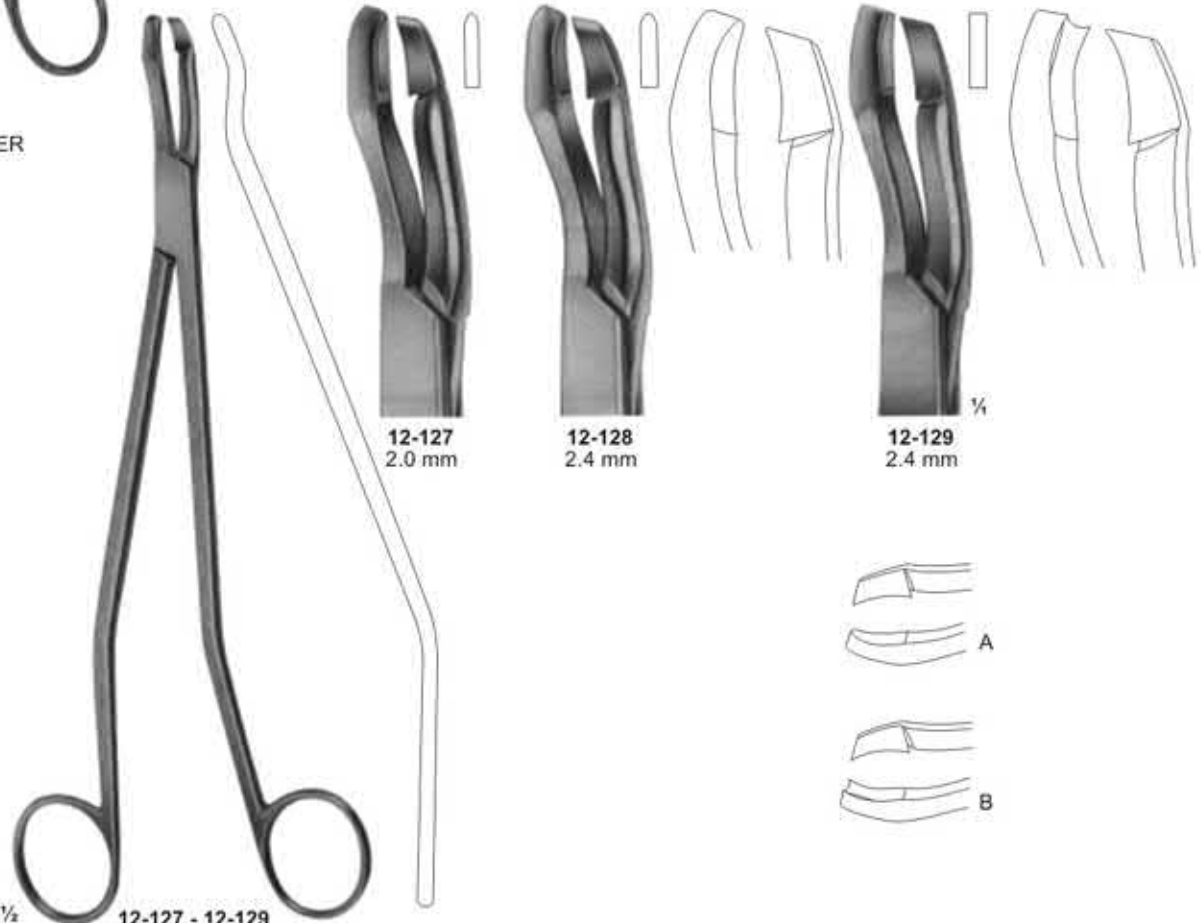

12-127
 2.0 mm

12-128
 2.4 mm

12-129
 2.4 mm

12-127 - 12-129
 SEIDL DBP
 Biopsy forceps, bayonet shaped
 for portio, vagina and vulva
 240mm



Biopsy Forceps

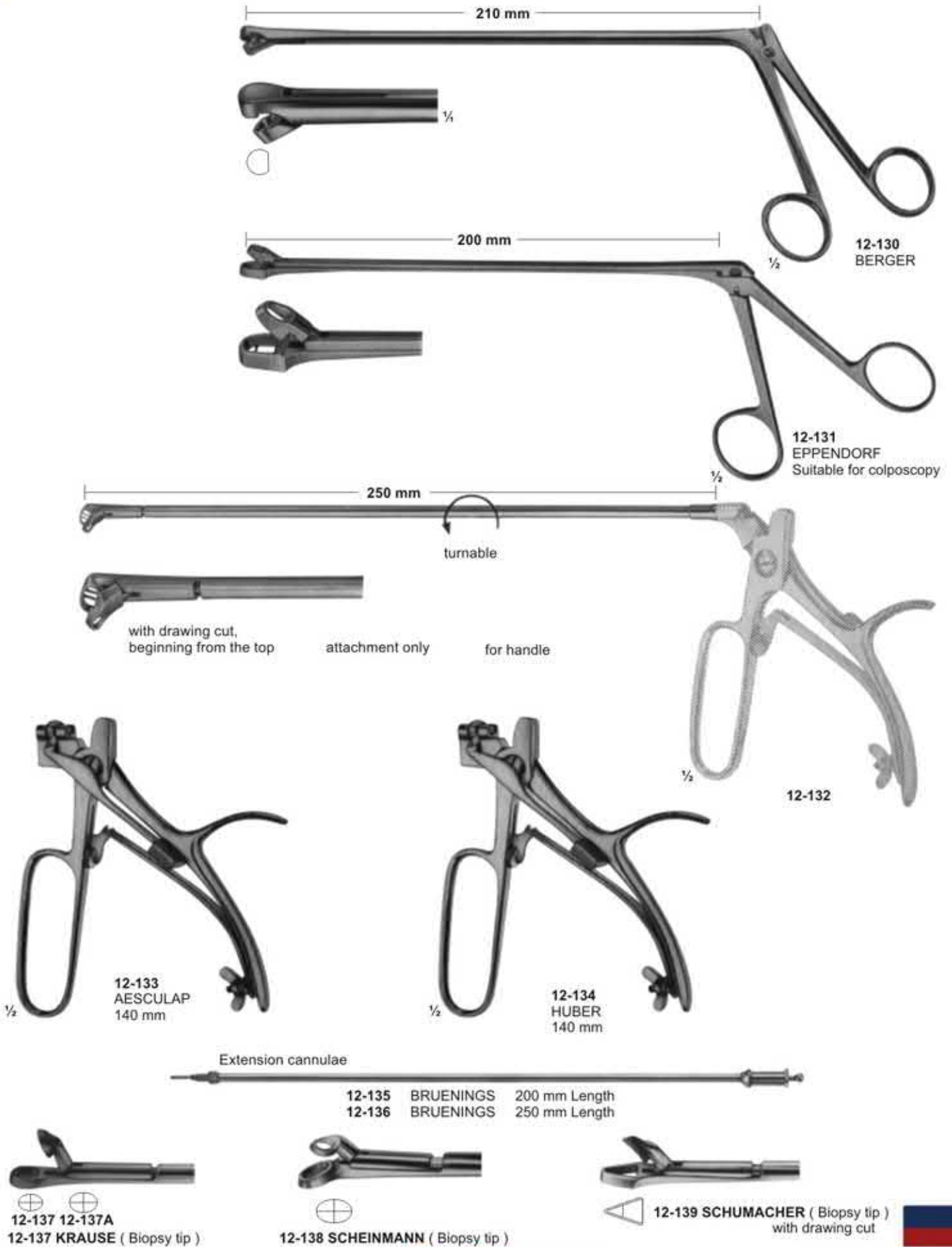

Uterine Scoops



12-140
 SIMON
 240 mm

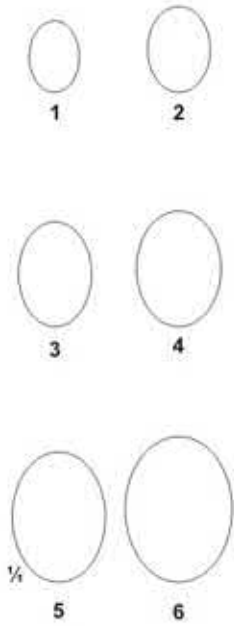

12-141
 SCHROEDER
 310 mm

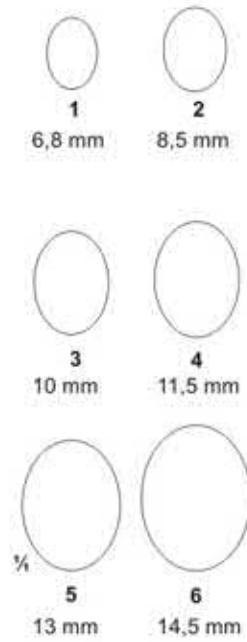

12-142
 RECAMIER
 300 mm

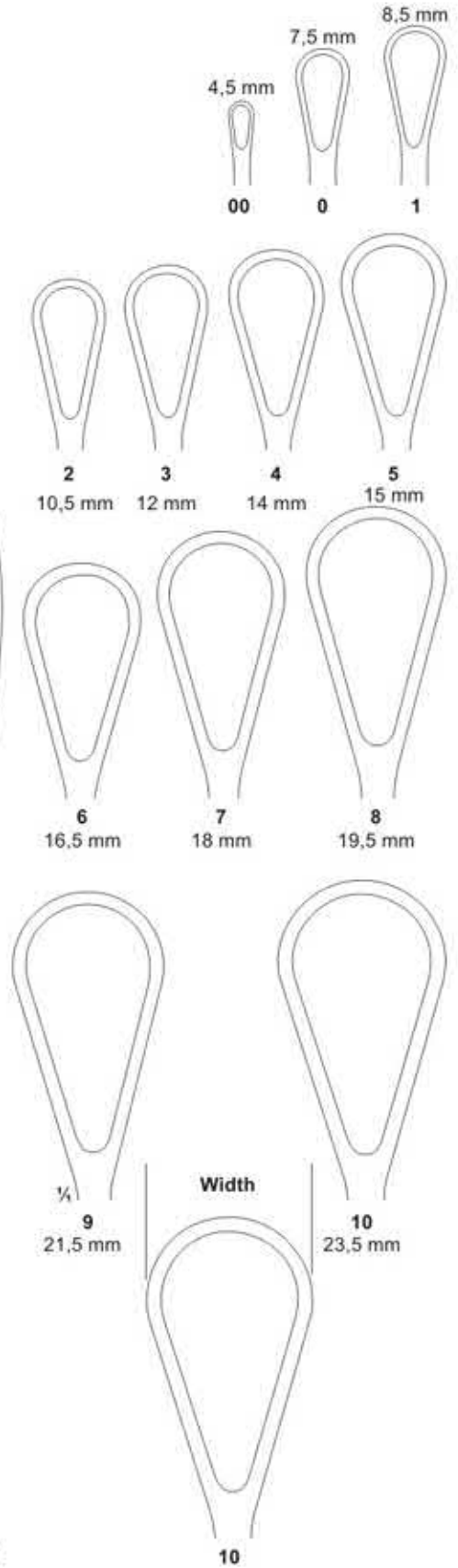

Obstetrical Forceps



13-101
NAEGELE
355 mm



13-102
NAEGELE
400 mm



13-103
SIMPSON-BRAUN
305mm

Obstetrics- Placenta and Ovum Forceps

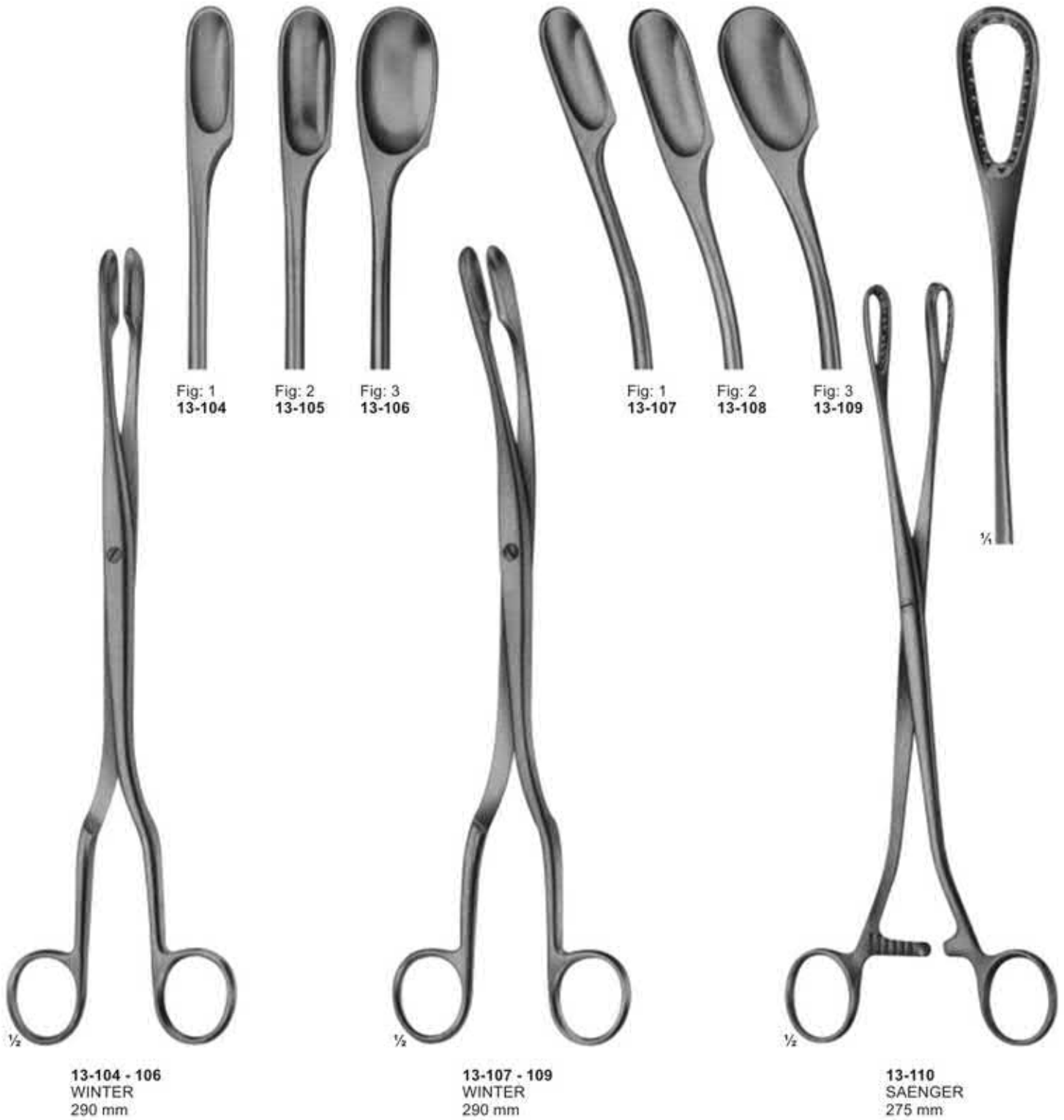

Tound-and Tracheal Hooks and Dilators



13-111
BOSE
165 mm



13-112
BOSE
165 mm



13-113 - 115
180 mm



13-114
blunt



13-115
stumpf/blunt



13-116
FINSEN
50 mm



13-117
FINSEN
70 mm



13-118
TROUSSEAU
120 mm



13-119
LABORDE
125 mm



13-120
LABORDE
strong pattern
135 mm



13-121
Cleaning Brush
for tracheal tubes
285 mm

Vascular Spatulas

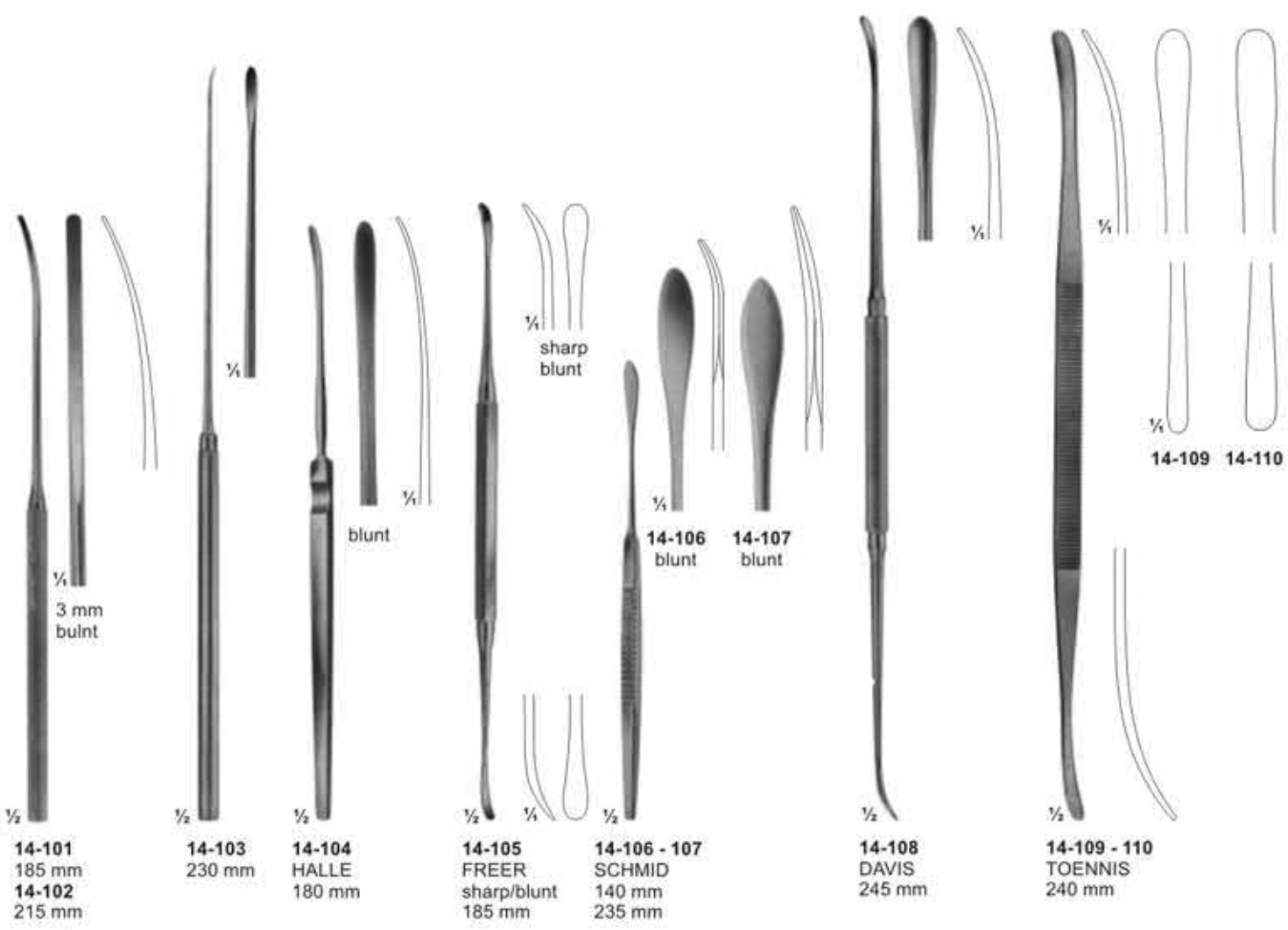

14-101
185 mm
14-102
215 mm

14-103
230 mm

14-104
HALLE
180 mm

14-105
FREER
sharp/blunt
185 mm

14-106 - 107
SCHMID
140 mm
235 mm

14-108
DAVIS
245 mm

14-109 - 110
TOENNIS
240 mm

ATRAUMATA
Forceps

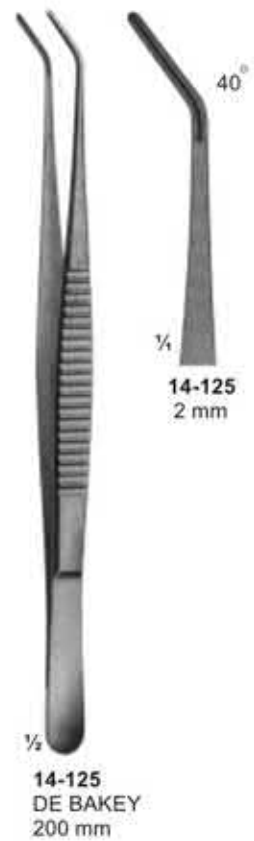
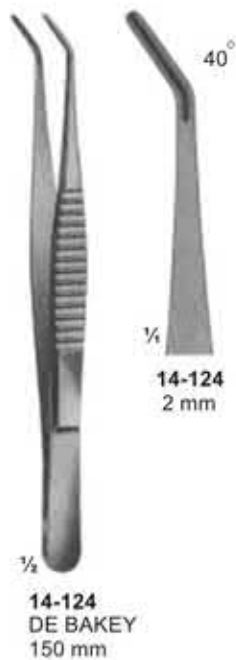
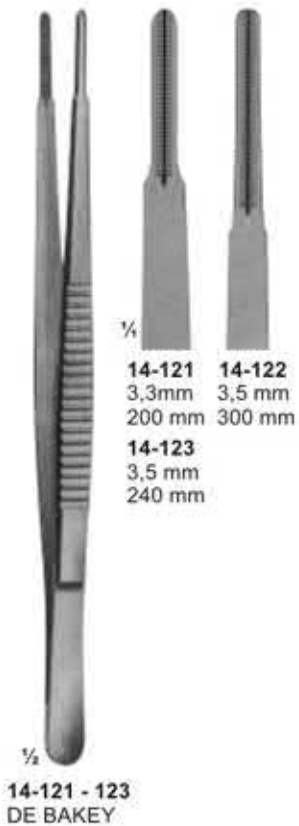
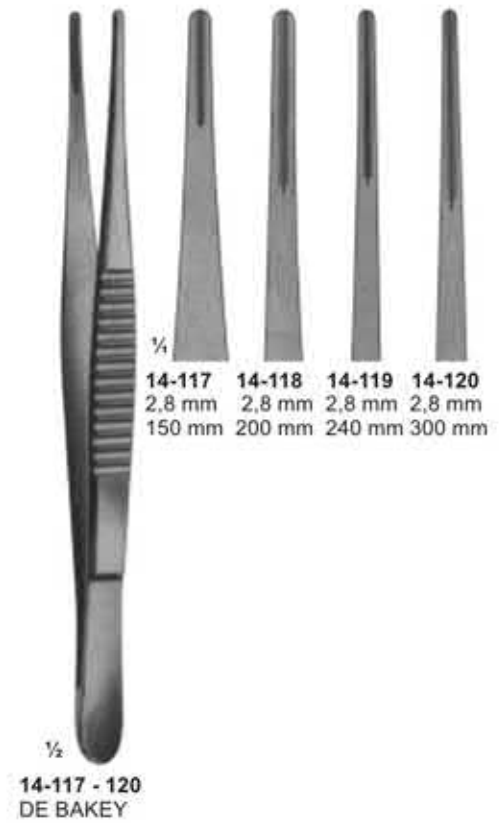
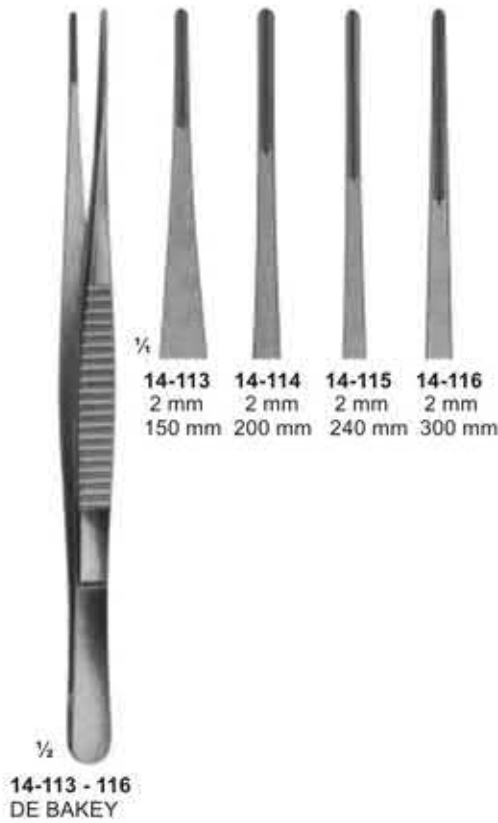
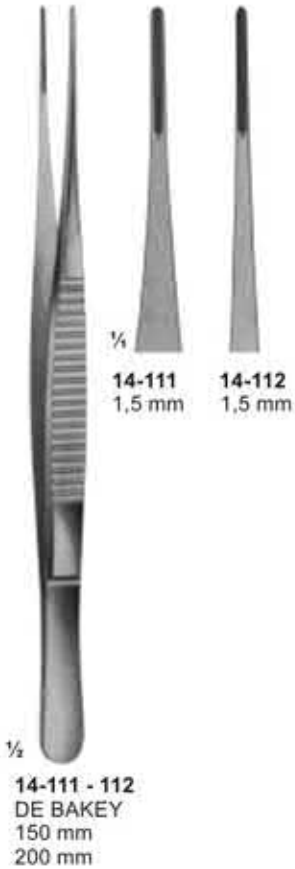

ATRAUMATA
Anastomosis- and Multi- Purpose-
Clamps- Pediatric types

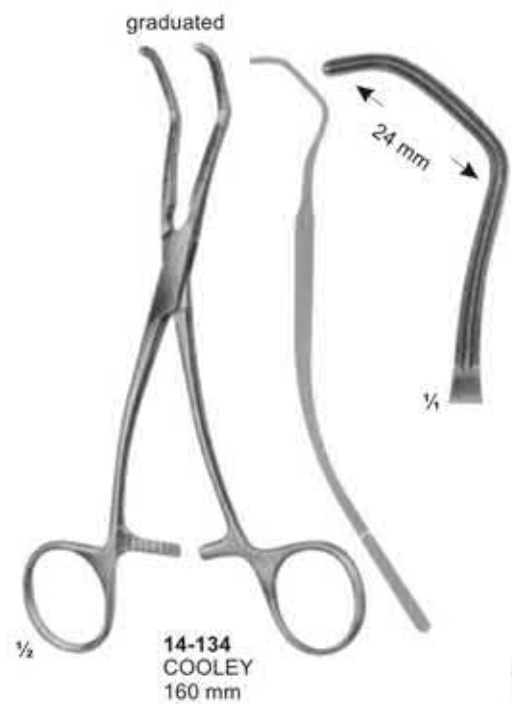
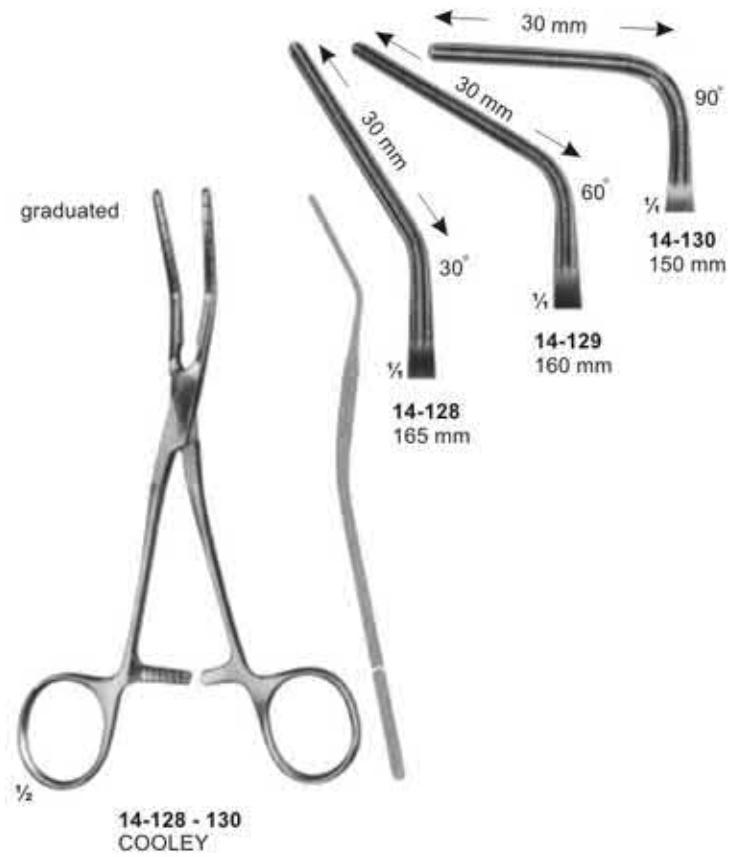
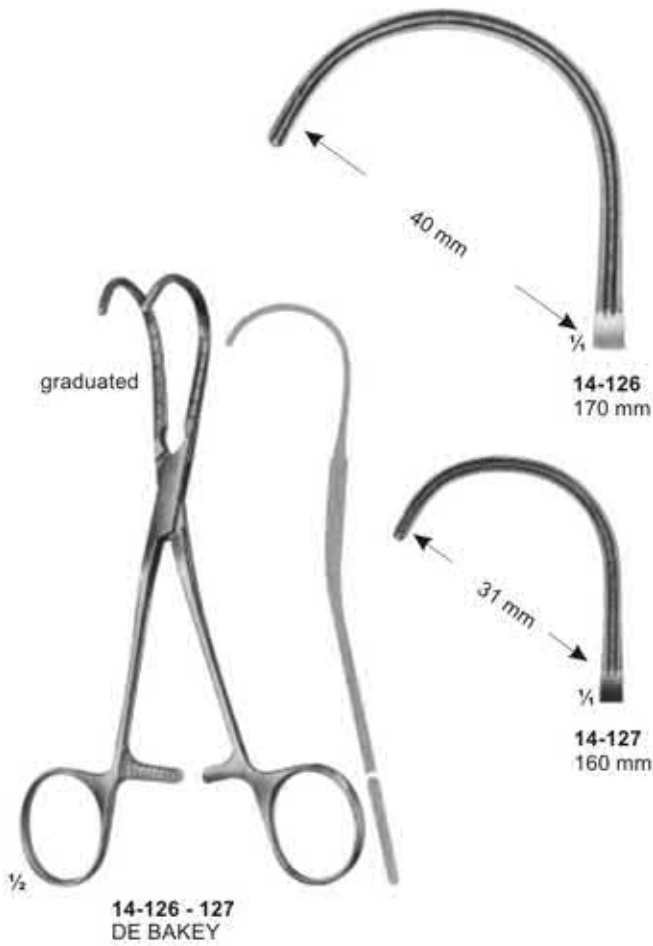

ATRAUMATA
 Coarctation Clamps, Patent-Ductus &
 Peripheral-Vascular Clamps

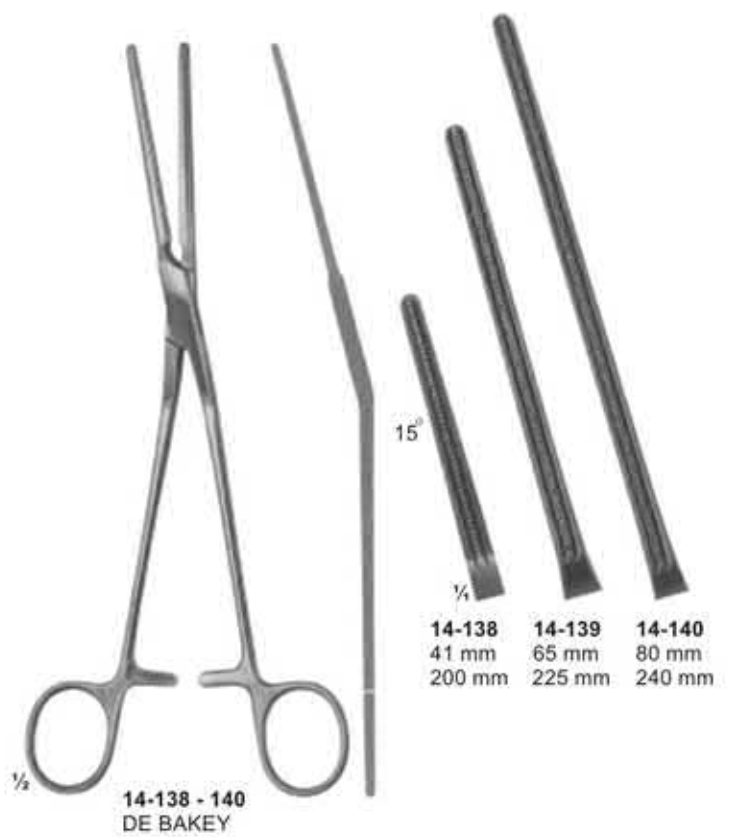

Aorta- Anastomosis Clamps

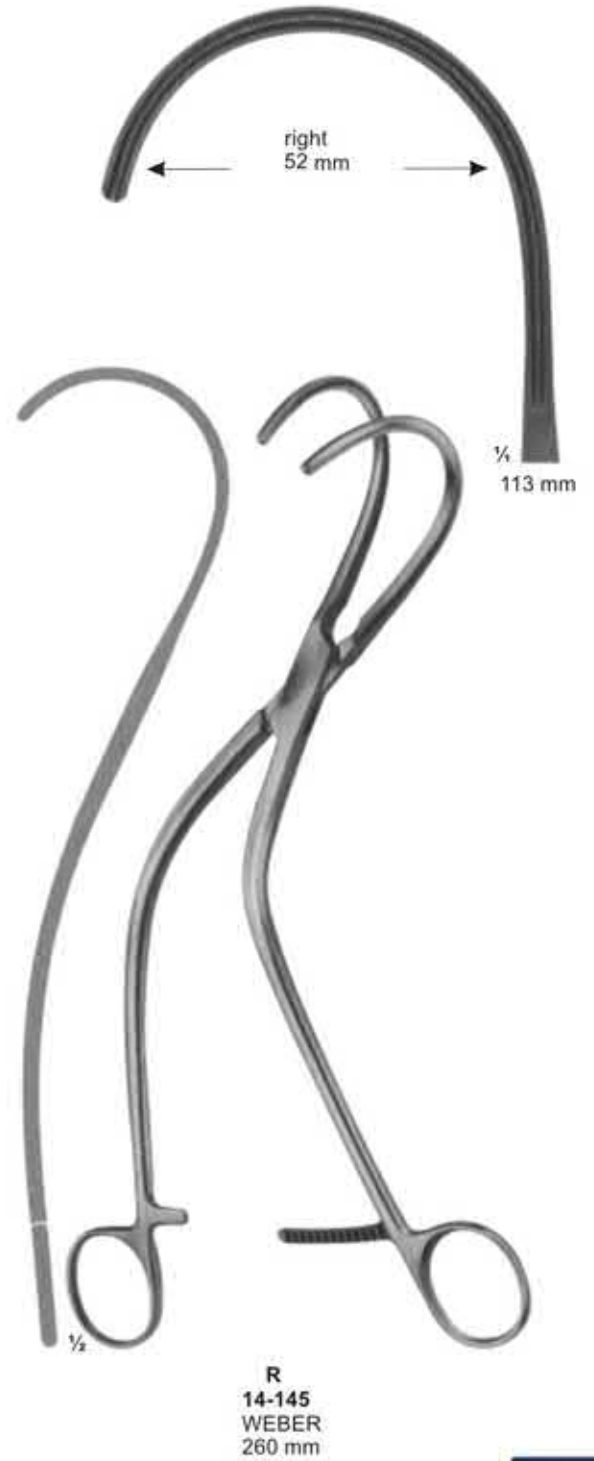
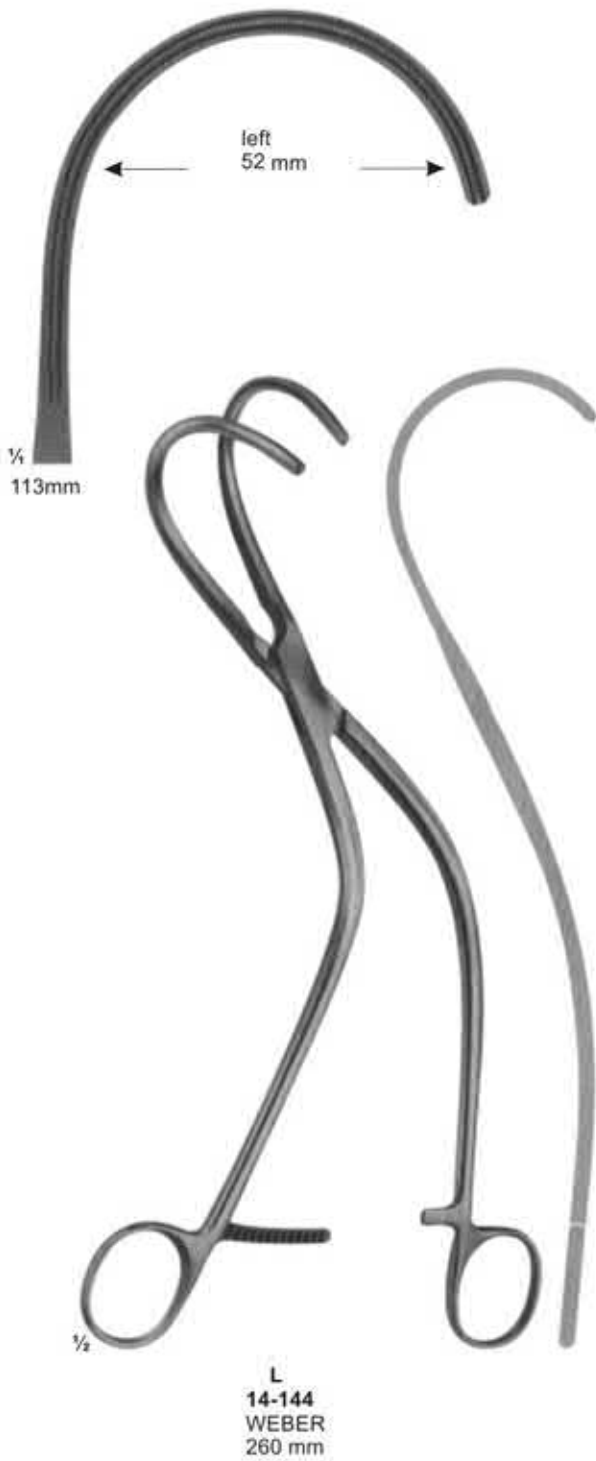

Multi- Purpose-Clamps



14-146 - 149
DE BAKEY

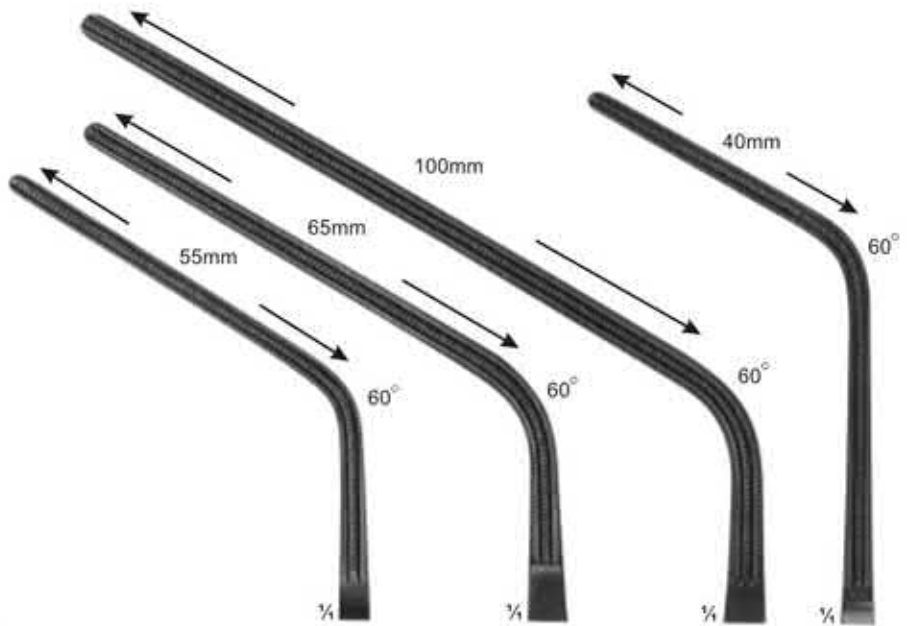

14-146 14-147 14-148 14-149

Total Length:	230 mm	280 mm	305 mm	240 mm
Length of jaws:	85 mm	100 mm	135 mm	93 mm



14-150 - 153
DE BAKEY

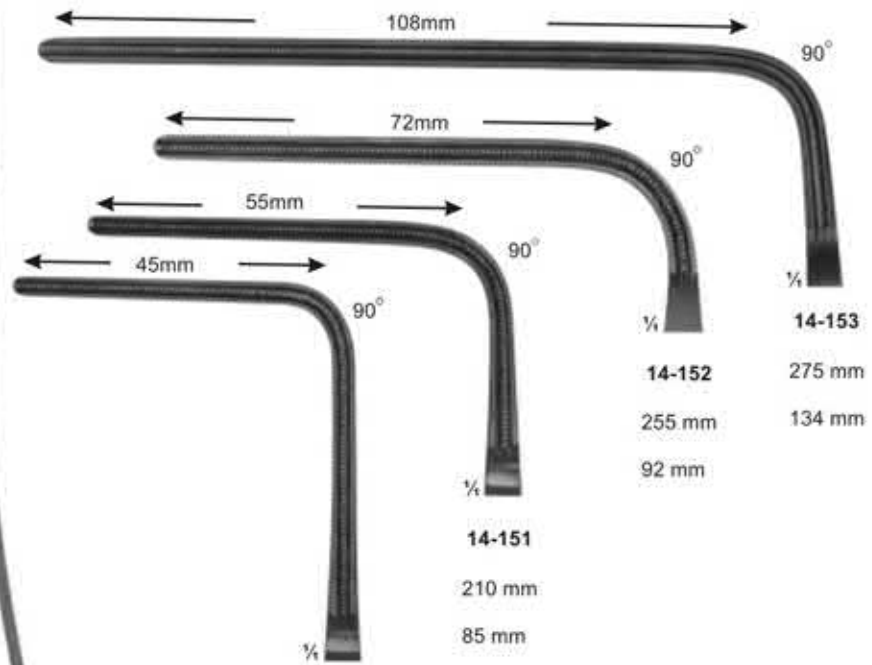

14-150 14-151 14-152 14-153

Total Length:	225 mm	210 mm	255 mm	275 mm
Length of jaws:	93 mm	85 mm	92 mm	134 mm

Sternum Instruments and Rib Shears



14-154
SCHUMACHER
 Sternum shears
 210 mm



14-155
LEBSCHÉ
 Sternum chisel
 200 mm



14-156
 230 mm



14-157
COLLIN
 195 mm



14-158
GLUCK
 190 mm



14-159
BETHUNE
 340 mm



14-160
BRUNNER
 Universal pattern
 340 mm



14-161
GIERTZ-STILLE
 250 mm

Rib Spreaders



14-162
FINOCHIETTO
 Blades
 18X21 mm

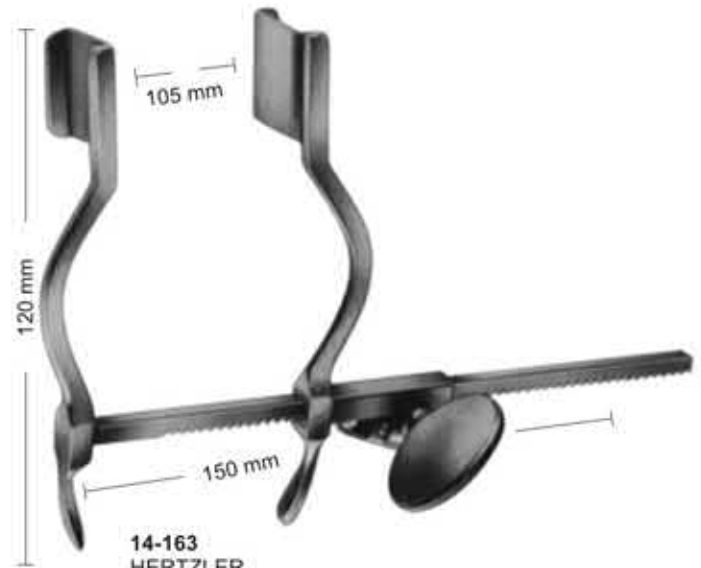

14-163
HERTZLER
 Blades
 20X25 mm

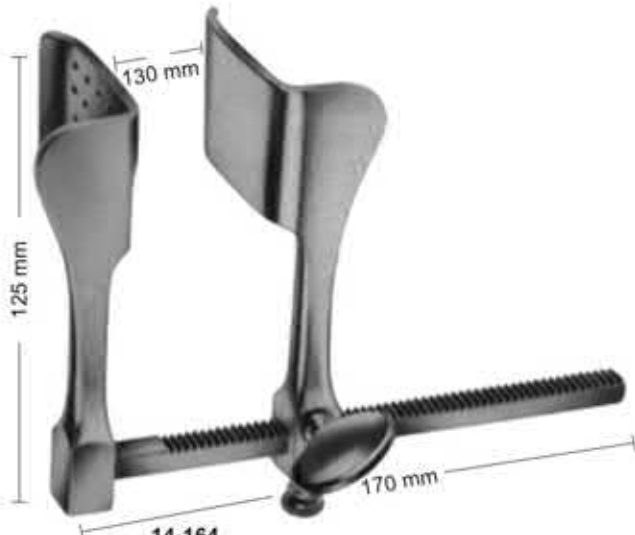

14-164
TUFFIER
 Blades
 43X53 mm

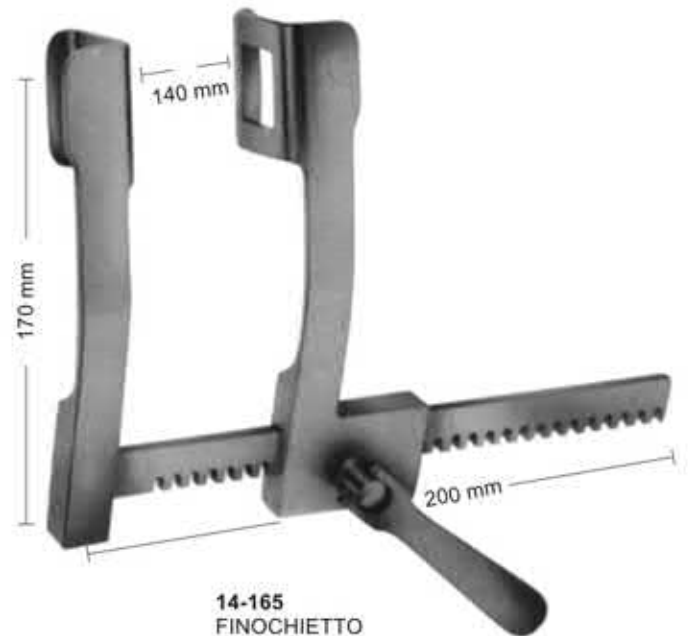

14-165
FINOCHIETTO
 Blades
 36X45 mm

Rib Spreaders-and Contractors



1/2

**14-166
 SELLORS**
 Rib spreader-and contractor
 with swivel blades
 200 mm



1/2

**14-167
 BAILEY**
 150 mm



14-168
 for children

14-169
 for adults

1/2

**14-168 - 169
 BAILEY**
 200 mm

Punches

130° upwards cutting

15-101
1 mm



KERRISON - JACOBY

FERRIS-SMITH-KERRISON

15-102
2 mm



15-103
3 mm



15-104
4 mm



15-105
5 mm

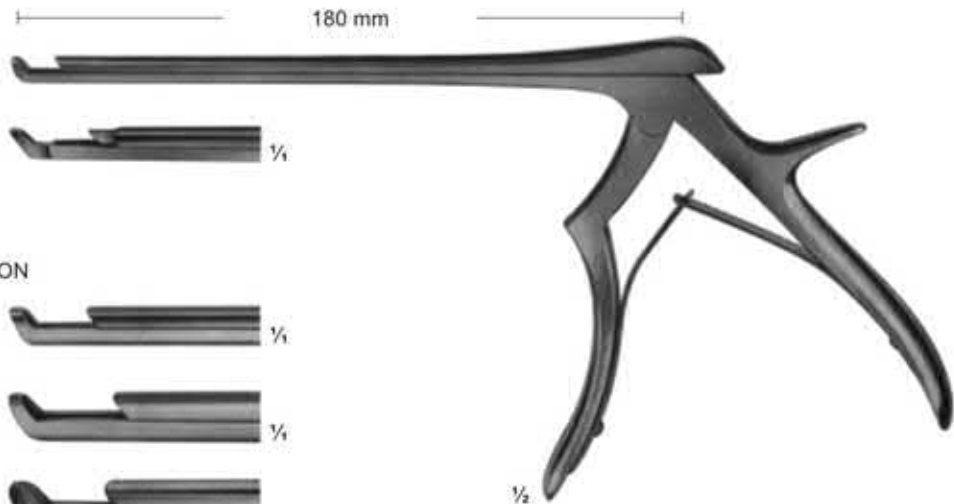

15-101 - 105

90° upwards cutting

KERRISON - JACOBY

15-106
1 mm



15-107
2 mm



FERRIS-SMITH-KERRISON

15-108
3 mm



15-109
4 mm



15-110
5 mm

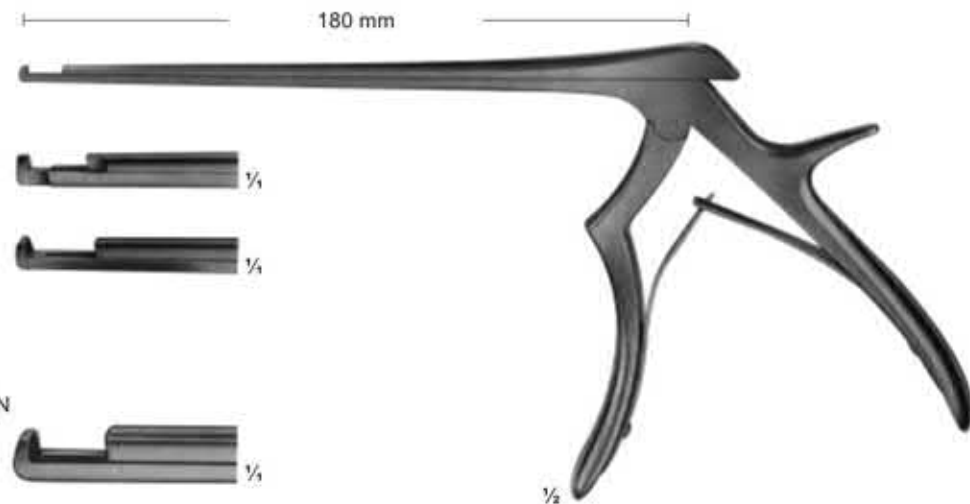

15-106 - 110

Punches

90° upwards cutting

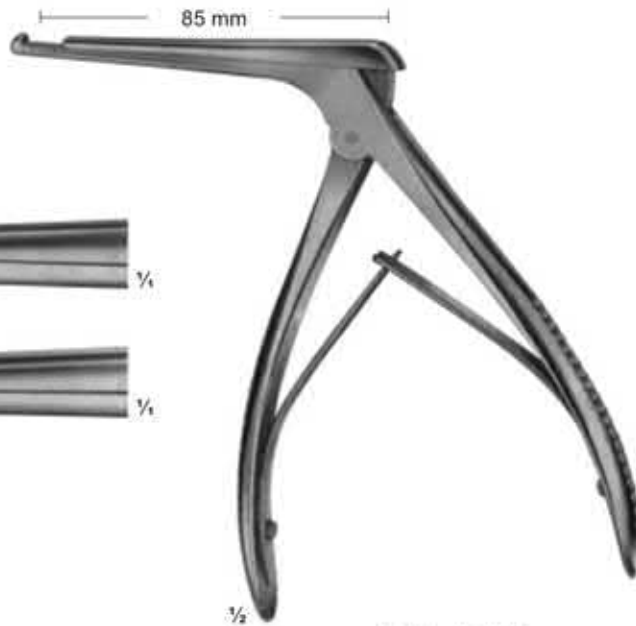

15-111
4 mm



15-112
5 mm



15-111 - 15-112
KERRISON

90° upwards cutting

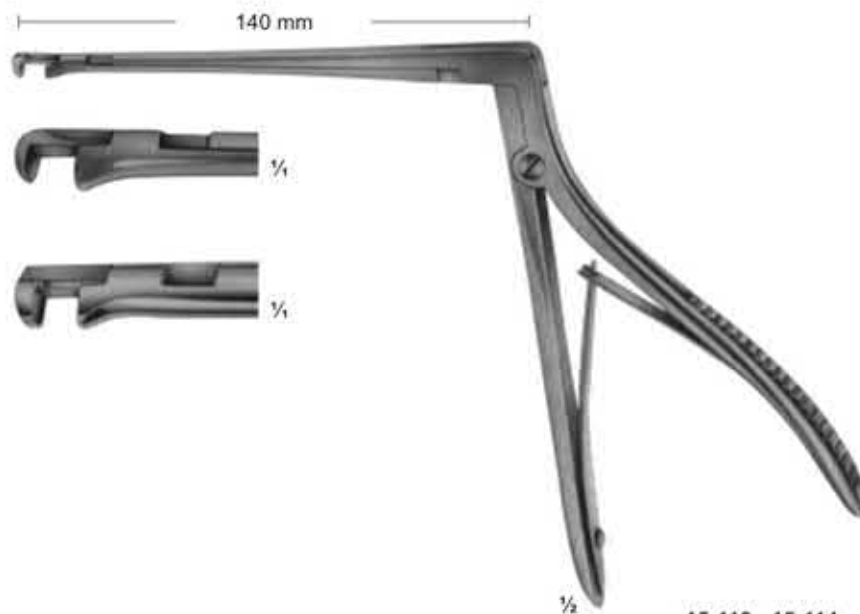

15-113
3,3 mm



15-114
4,0 mm



15-113 - 15-114
HAJEK-KOFLER

Rongeurs

LOVE-GRUENWALD

15-115
 2 X 10 mm

15-116
 3 X 10 mm

SPURLING
15-117
 4 X 10 mm



15-115 - 15-117

15-118
 2 mm

15-119
 3 mm

15-120
 4 mm

15-121
 5 mm

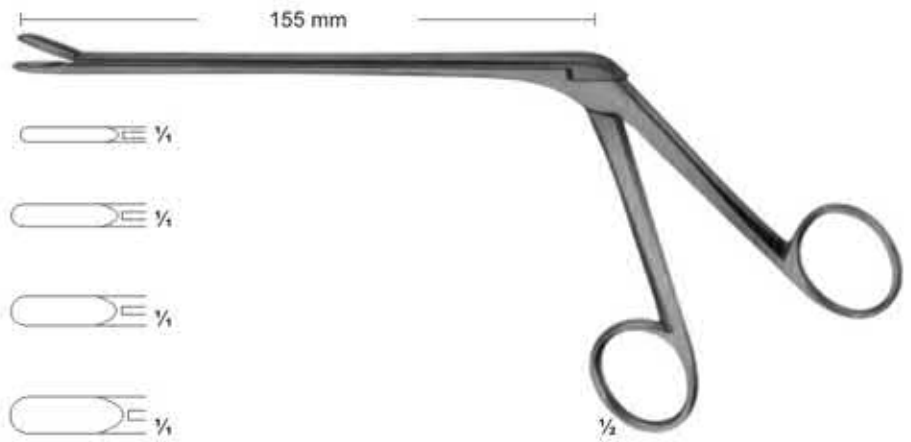

15-118 - 15-121
CASPAR

150°

15-122
 2 mm

15-123
 3 mm

15-124
 4 mm

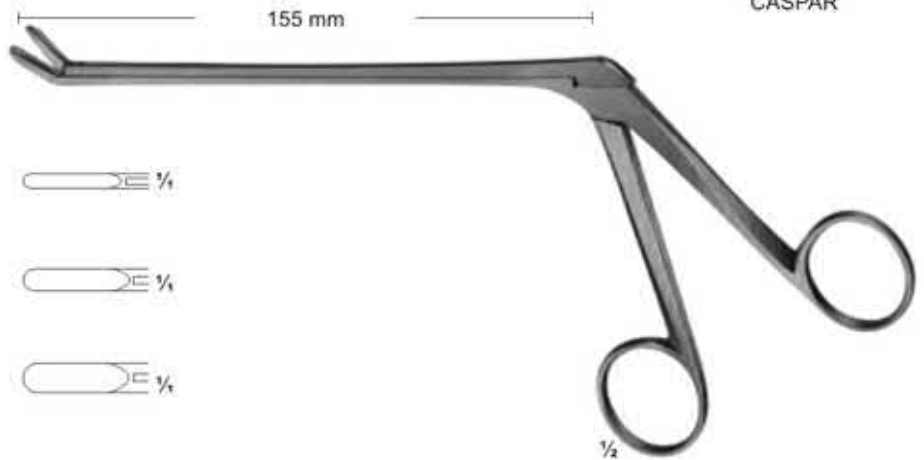

15-122 - 15-124
CASPAR

Rongeurs

Angled positions for rongeurs

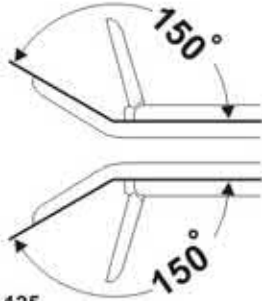

15-125
3,0 mm

15-126
3,6 mm

15-127
4,2 mm

15-128
4,8 mm

15-129
5,8 mm

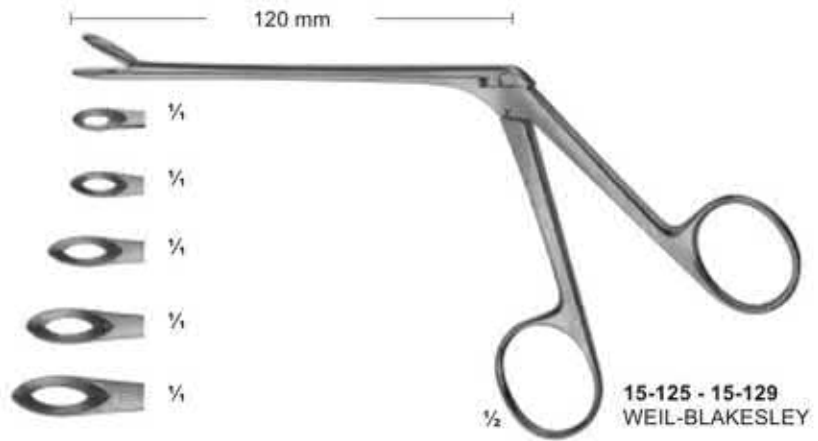
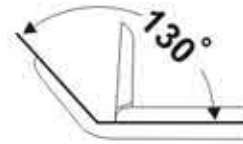
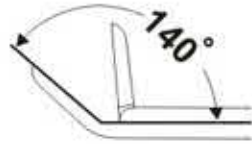

130°

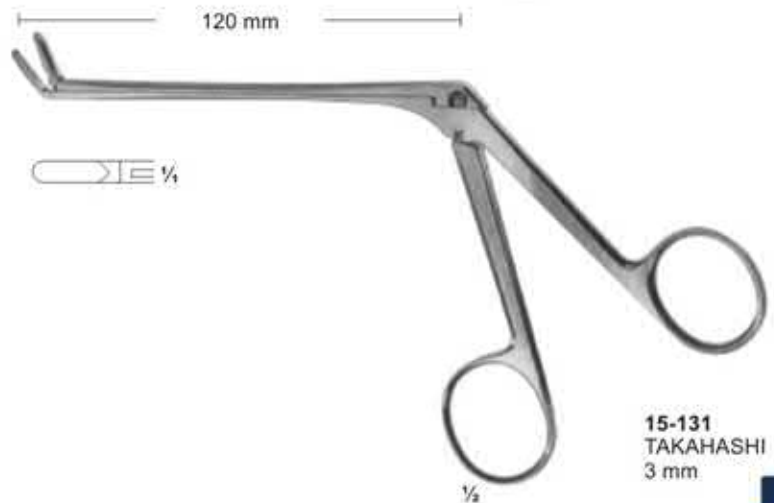

Rongeurs

150°

Lower part of jaws movable

15-132
2 mm

15-133
3 mm

15-134
4 mm



15-132 - 15-134
CASPAR

Length of shaft 140 mm	Length of shaft 160 mm	Length of shaft 185 mm	size of jaws
15-135	15-140	15-145	2 X 12 mm
15-136	15-141	15-146	3 X 12 mm
15-137	15-142	15-147	4 X 14 mm
15-138	15-143	15-148	5 X 14 mm
15-139	15-144	15-149	6 X 16 mm

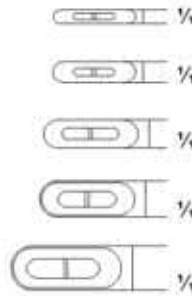

15-135 - 15-149
CASPAR

150°

Length of shaft 140 mm	Length of shaft 160 mm	Length of shaft 185 mm	size of jaws
15-150	15-153	15-156	3 X 12 mm
15-151	15-154	15-157	4 X 14 mm
15-152	15-155	15-158	5 X 14 mm



15-150 - 15-158
CASPAR

Rongeurs

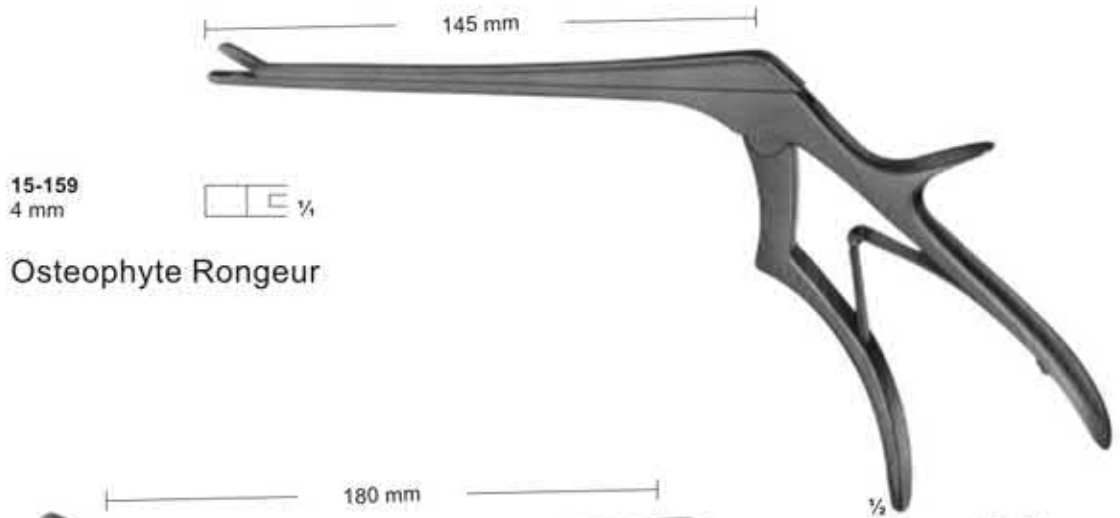

15-159
CASPAR

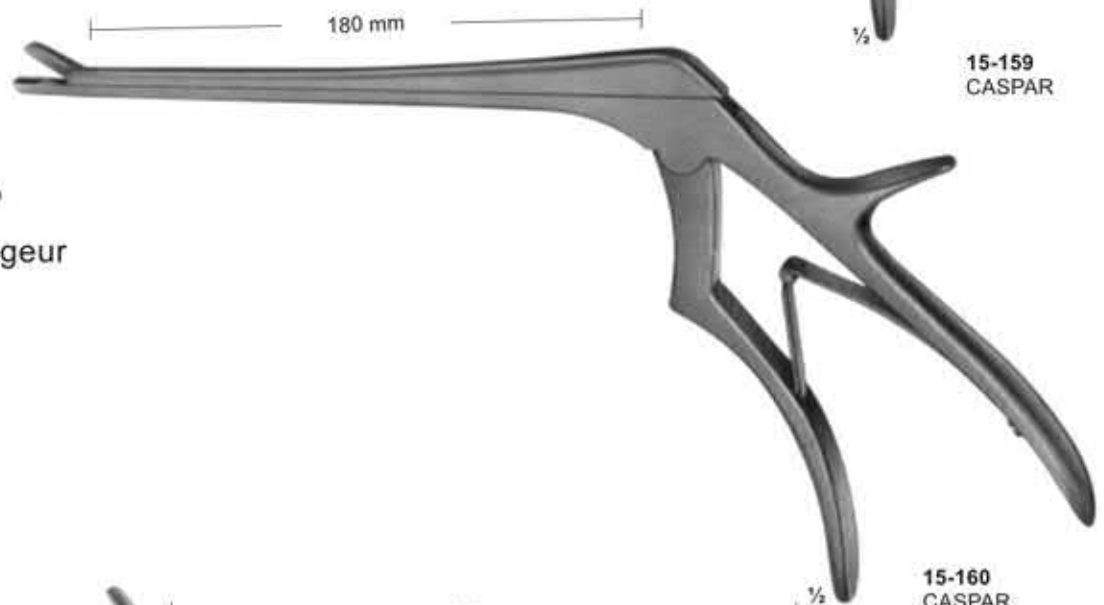

15-160
CASPAR

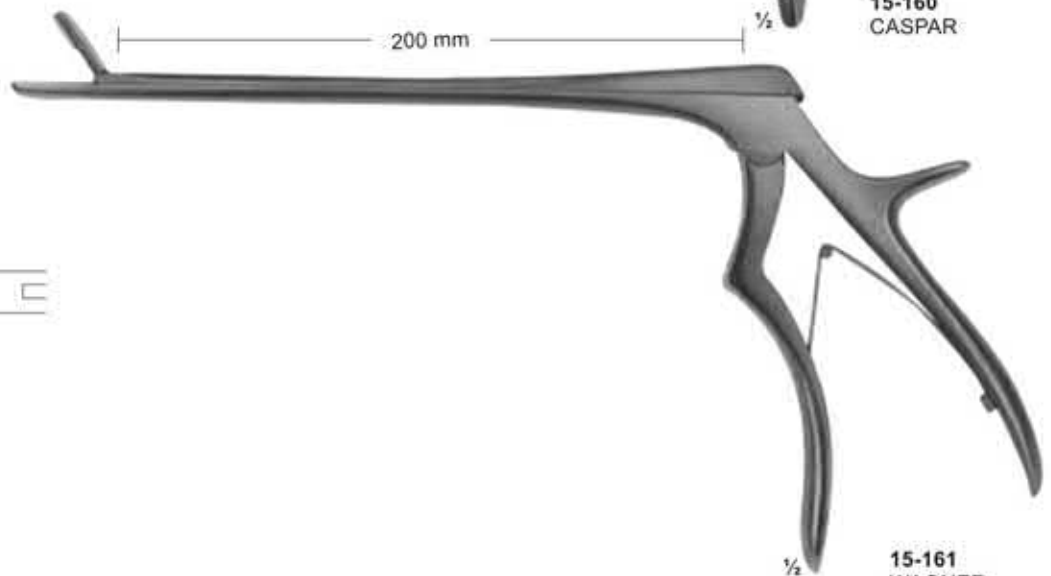

15-161
WAGNER

Elevators and Bone Levers

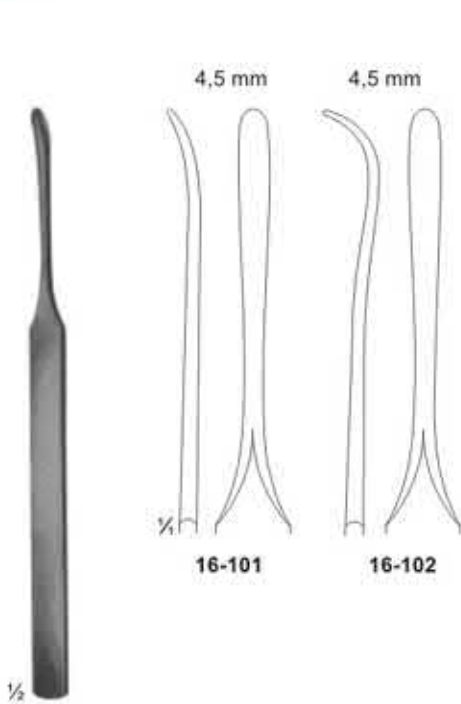

16-101 - 102
KONIG
 155 mm



16-103
WILLIGER
 165 mm

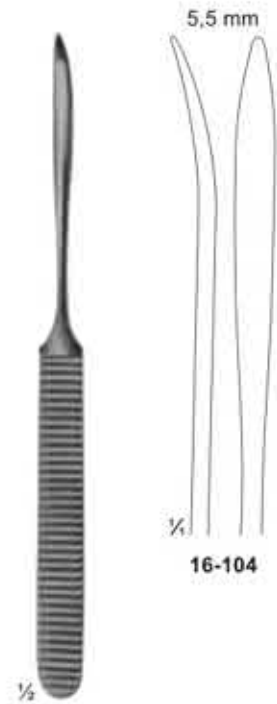

16-104
WILLIGER
 170 mm



16-105
QUERVAIN
 195 mm

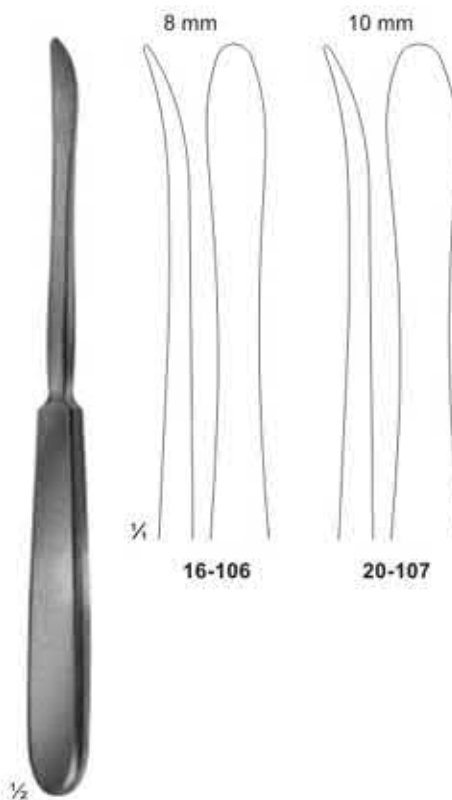

16-106 - 107
LANGENBACK
 195 mm

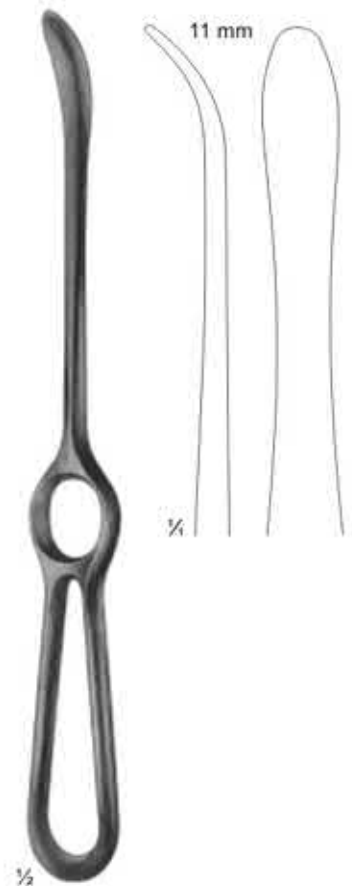

16-108
LANGENBACK
 230mm

Bone Levers



1/2
16-109
 LANE TRETHOWAN
 215mm

1/2
16-110
 LANE
 255mm

1/2
16-111
 LANGE-HOHMANN
 250mm

1/2
16-112 - 113
 LANGE-HOHMANN modif.
16-112 265mm
16-113 280mm

16-112
 30 mm
 16-113
 33 mm

Raspatories



16-114
 PARTSCH
 150 mm



16-116
 PARTSCH mod. LANGE
 145 mm



16-117
 MC KENTY
 155 mm

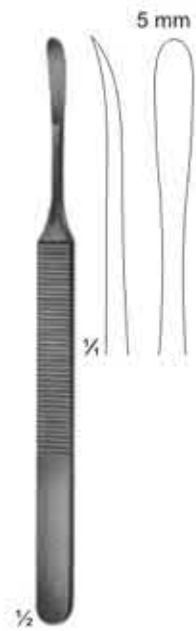

16-118
 KOENIG
 155 mm

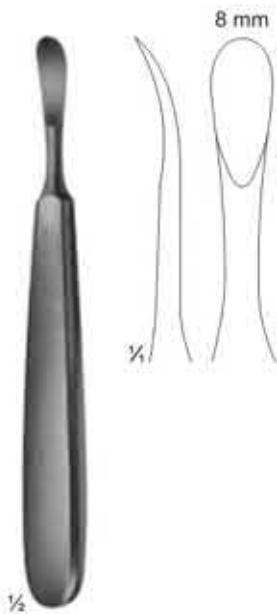

16-119
 TRELAT
 150 mm

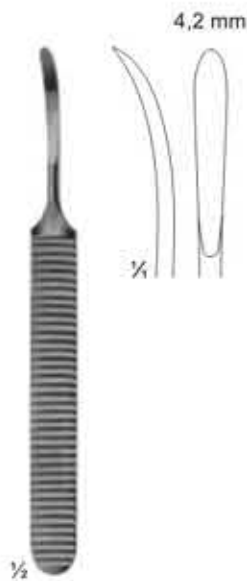

16-120
 WILLIGER
 140 mm



16-121
 WILLIGER
 160 mm

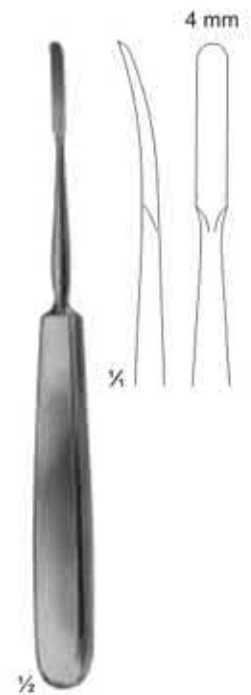

16-122
 JOSEPH
 170 mm

Bone File and Rasps

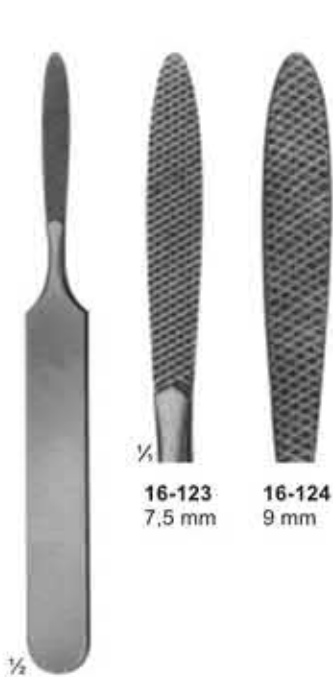

16-123
7.5 mm

16-124
9 mm

16-123
JOSEPH
fine, chequered

16-124
coarse, chequered
165 mm

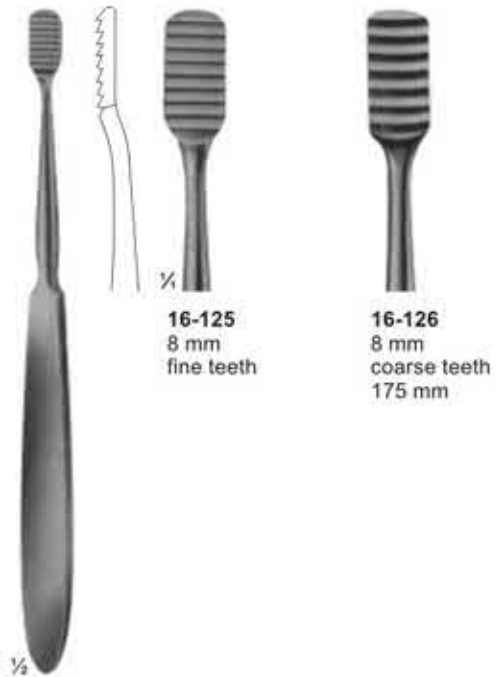

16-125
8 mm
fine teeth

16-126
8 mm
coarse teeth
175 mm

16-125 - 16-126
LEWIS



16-127
9 mm

16-127
MALTZ
down stroke
180 mm

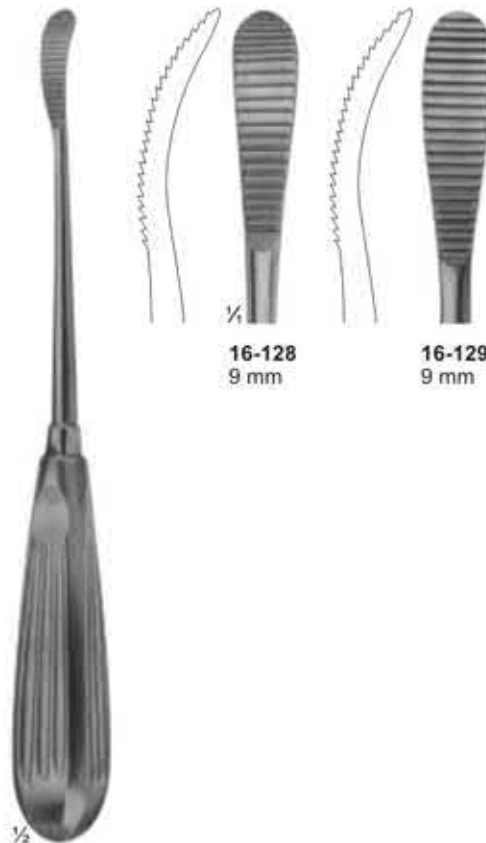

16-128
9 mm

16-129
9 mm

16-128 - 16-129
AUFRICHT
up stroke
16-129
down stroke
220 mm



16-130
6.5 mm

16-130
GALLAHER
190 mm

Bone Currettes



16-131
JACOBSON
 140 mm



16-132
MARTINI
 140 mm



16-133
MARTINI
 140 mm



16-134
WILLIGER
 145 mm



16-135
JANSEN
 160 mm



16-136
BARTH
 180 mm



16-137
VOLKMANN
 130 mm



16-138
VOLKMANN
 145 mm



16-139
VOLKMANN
 170 mm

Mallets Weights refer to the heads of the mallets
Hammer Die Gewichtsangaben beziehen sich auf den Kopf des jeweiligen Hammers



17-101
 MEAD
 185 g
 with interchangeable
 plastic disks
 190 mm
17-102
 pair of spare disks



17-103
 140 g
 with interchangeable
 plastic disks
 185 mm
17-104
 pair of spare disks.



17-105
 COTTLE
 140 g
 1 Side Flat
 1 Side convex
 185 mm



17-106
 165 g
 lead filled head
 190 mm

Osteotomes, Chisels and Gouges



17-107
MANNERFELT
 Gouge
 155 mm

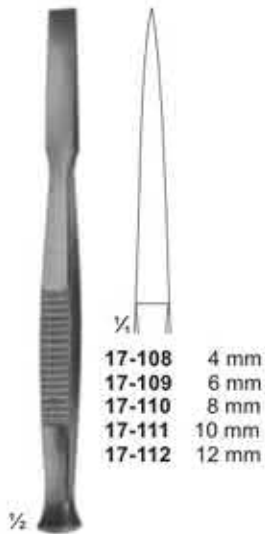

17-108 - 112
 Osteotomes
 140 mm

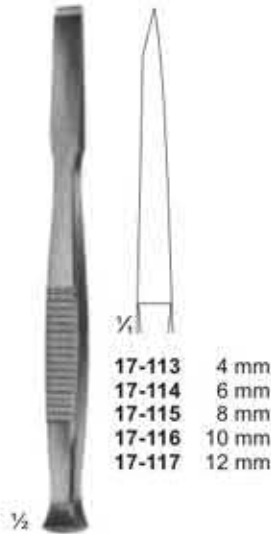

17-113 - 117
 Chisels
 140 mm

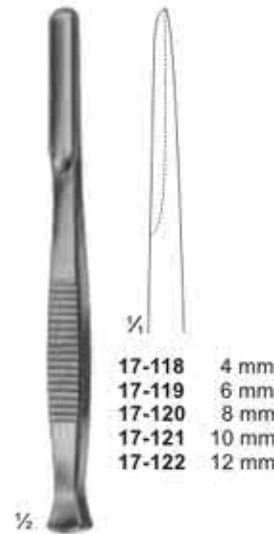

17-118 - 122
 Gouges
 140 mm

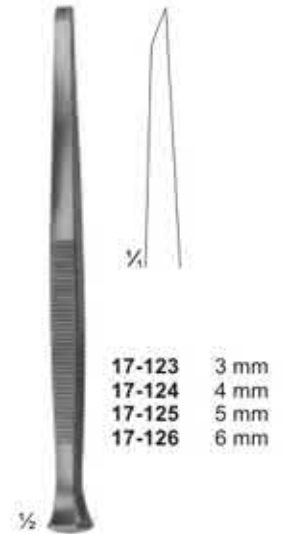

PARTSCH
17-123 - 126
 Chisels
 140 mm

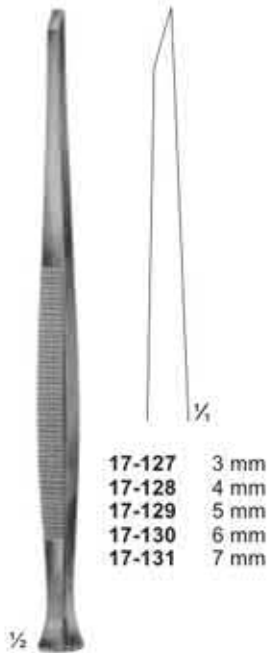

PARTSCH
17-127 - 131
 Chisels
 170 mm

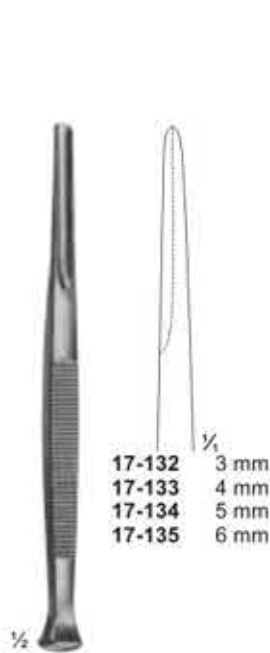

PARTSCH
17-132 - 135
 Gouges
 140 mm

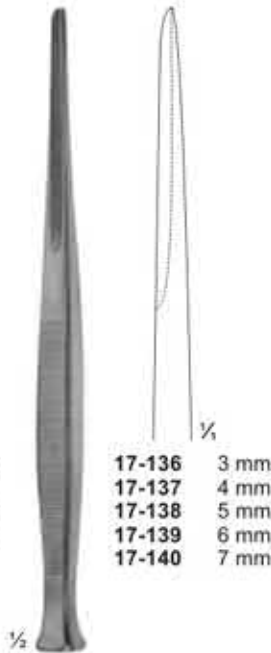

PARTSCH
17-136 - 140
 Gouges
 170 mm



LUCAS
17-141 - 142
 Chisels
 160 mm



LUCAS
17-143 - 144
 Gouges
 160 mm

Reposition Forceps, Bone Holding Forceps



17-145
 Patella forceps
 185 mm



17-146
 Forceps with
 ratchet fixation
 140 mm



17-147
 Forceps with
 thread fixation
 170 mm



17-148
 Forceps with
 thread fixation
 235 mm

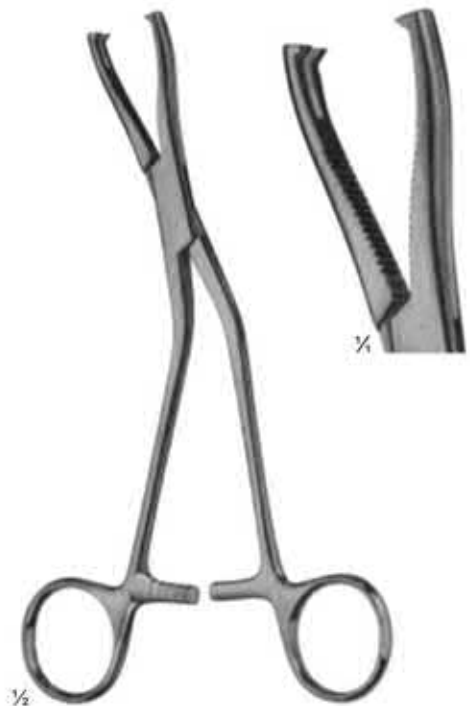

17-149
 DINGMANN
 185 mm

Bone Holding Forceps & Bone Clamps



Bone Rongeurs



17-158
 LUER
 150 mm



17-159
 LUER
 155 mm



17-160
 BLUMENTHAL
 155 mm



17-161
 BLUMENTHAL
 150 mm



17-162 - 163
 JANSEN
 175 mm

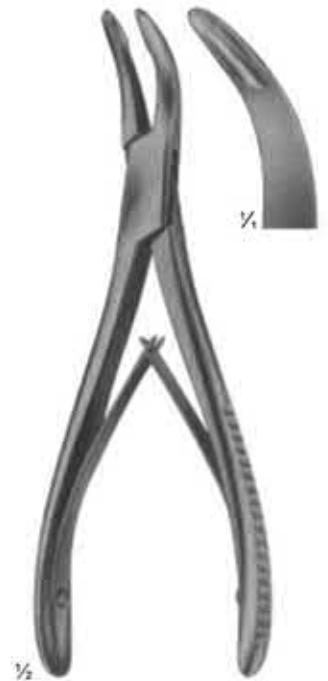

17-164
 BANE-HARTMANN
 175 mm

Bone Rongeurs



17-165
STILLE
235 mm



17-166
LEKSELL-STILLE
240mm



17-167
STILLE-RUSKIN
240mm

Bone Cutting Forceps



17-168
LISTON
curved on flat
240 mm



17-169
LISTON
straight
280 mm

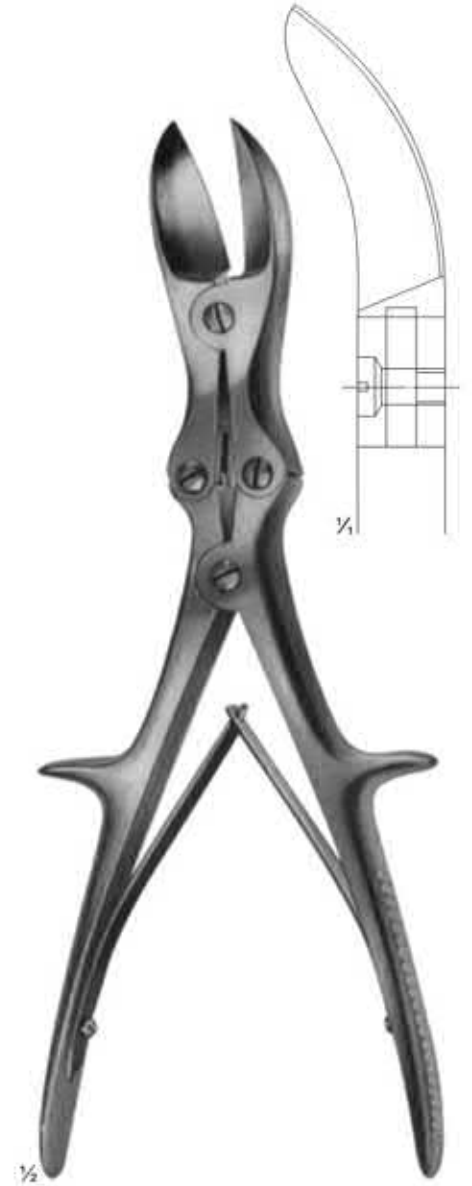

17-170
LISTON
curved on flat
280 mm

Wire Extension

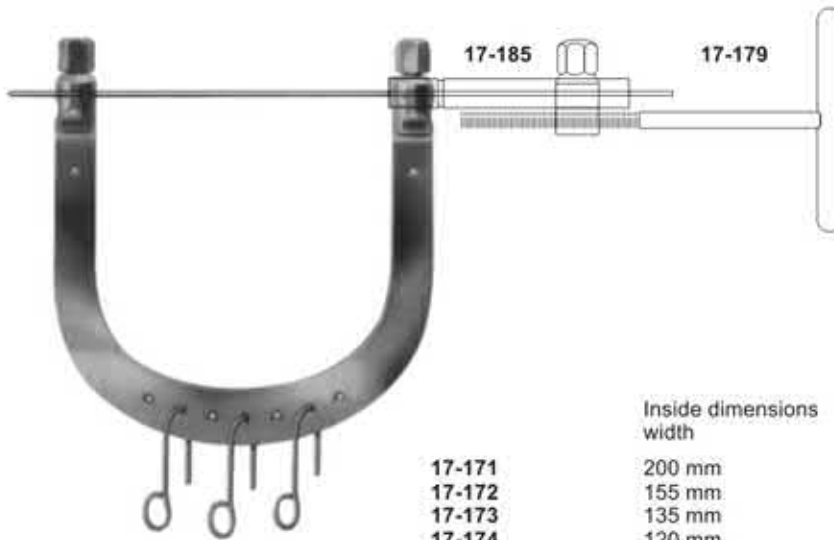

17-171 - 17-177
KIRSCHNER
 Wire traction bows,
 to be used with
 KIRSCHNER-wires
 up to 2.5 mm diam.,
 With 3 hooks,
 stainless steel

	Inside dimensions width	depth	
17-171	200 mm	155 mm	for the hip
17-172	155 mm	155 mm	for the femur
17-173	135 mm	130 mm	for the knee
17-174	120 mm	120 mm	for the knee
17-175	105 mm	100 mm	for the knee
17-176	95 mm	110 mm	for the calcaneus
17-177	95 mm	70 mm	for the arm and elbow



17-178
 Wrench, double - ended,
 for wire traction bows



17-179
 Wire tightener, with
 clamping jaws



17-182	max. 105 mm
17-183	max. 160 mm
17-184	max. 200 mm
17-182	80-95 mm
17-183	90-120 mm
17-184	140-170 mm
diam upto	
17-182	1,6 mm
17-183	2,0 mm
17-184	2,5 mm

17-182 - 17-184
KIRSCHNER
 Wire traction bows, modified,
 adjustable in width, holds wire
 securely, with 1 hook



17-180
 Traction hook only,
 large size



17-181
 Traction hook only,
 small size



17-185
 Fixation clamp, to secure clamping
 jaws of 17-179 stainless steel

Cerclage Instruments

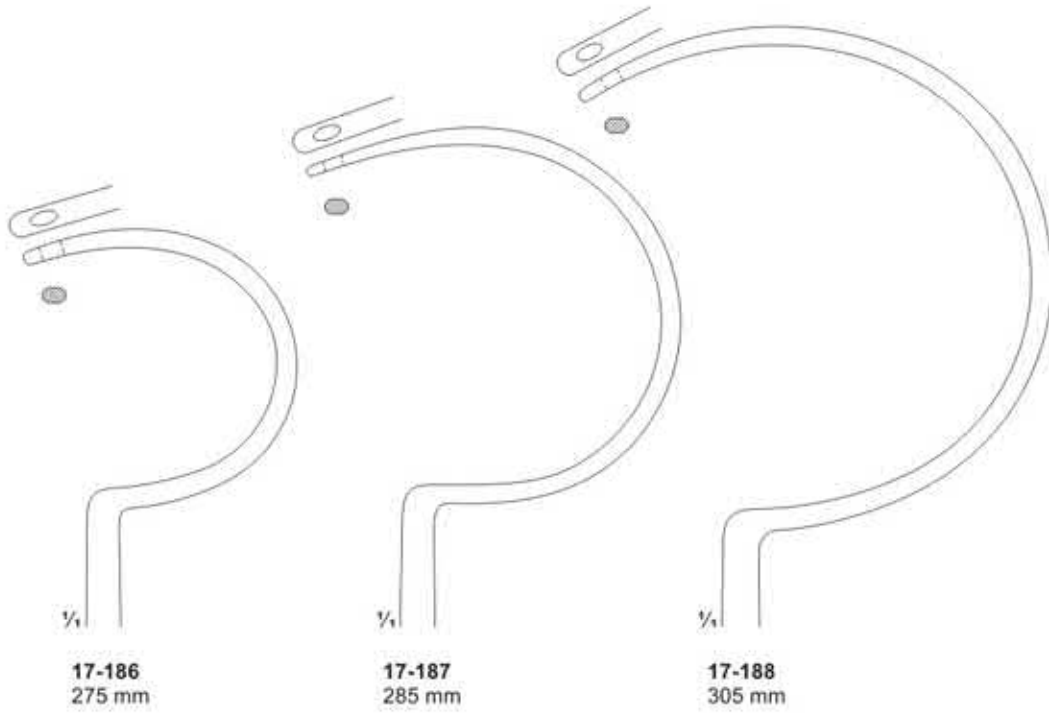

17-186 - 17-188
 DEMEL
 Wire guides

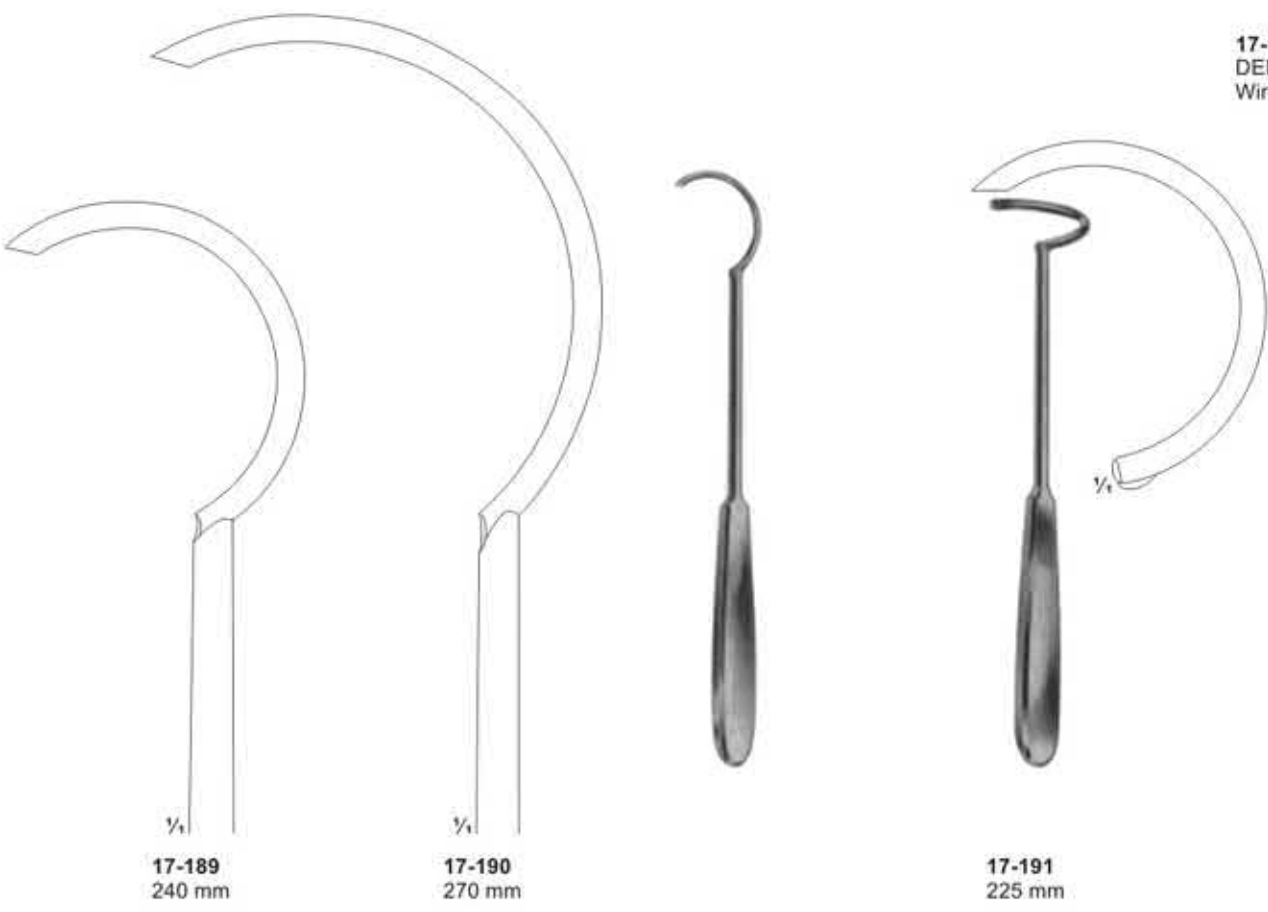

Wire Holding forceps, Wire Tightening Pliers, Flat-nosed Pliers DUROGRIP with Hard Metal Inserts



17-192
 DUROGRIP
 Holding forceps for cerclage wire, with lateral jaws to avoid wire slipping off
 170 mm



17-193
 DUROGRIP
 Wire, tightening pliers, Ligature pliers
 150 mm



17-194
 DUROGRIP
 Wire, tightening pliers, Ligature pliers
 150 mm



17-195
 with serrated jaws
 140 mm



17-196
 one jaw smooth, one jaw serrated
 140 mm



17-197
 with serrated jaws
17-198
 with longitudinal and transversal grooves
 170 mm



17-199
 190 mm

**Wire Holding forceps, Flat-nosed Pliers,
 Pliers for bending and cutting wires**

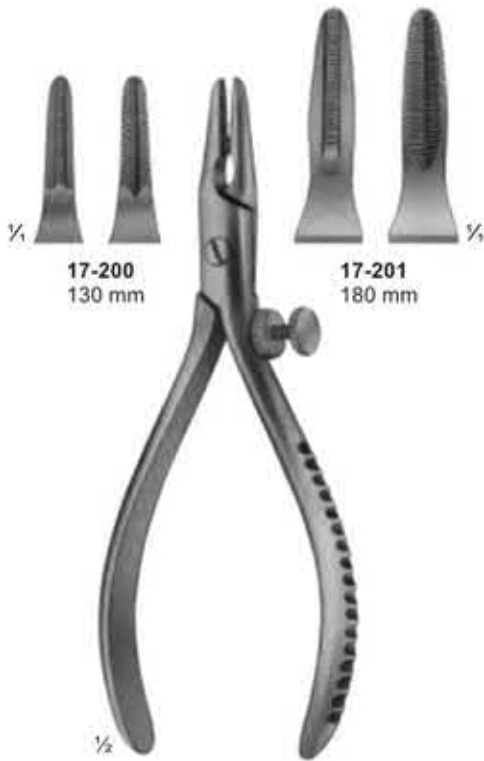

17-200 - 17-201
 Extraction pliers
 for boring wires



17-202
 Flat-nosed pliers,
 parallel
 185 mm

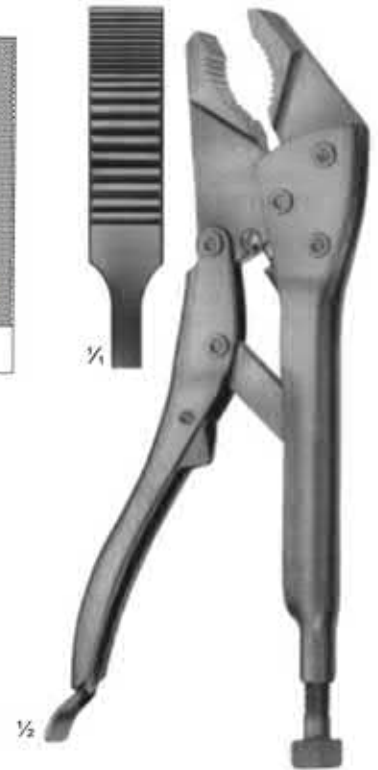

17-203
 Vise grip
 200 mm



17-204
 Round Pliers
 180mm

17-205 145 mm
17-206 180 mm
17-207 180 mm
 Extraction pliers for wires



17-208
 Bending pliers
 for wires up to
 1.8 mm diam.

Wire Cutters and wire Cutting Scissors DUROTIP with Carbide Cutting Edges



17-209
ANGLE
130 mm

for soft wire
up to diam.
for hard wire
up to diam.

0,5 mm
0,3 mm

17-210
DUROTIP
ANGLE
130 mm

0,6 mm
0,4 mm

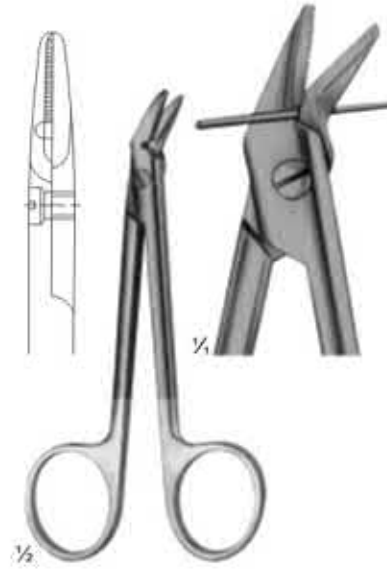

17-211
120 mm

for soft wire
up to diam.
for hard wire
up to diam.

1,2 mm
0,8 mm

17-212
DUROTIP
120 mm

1,2 mm
0,8 mm

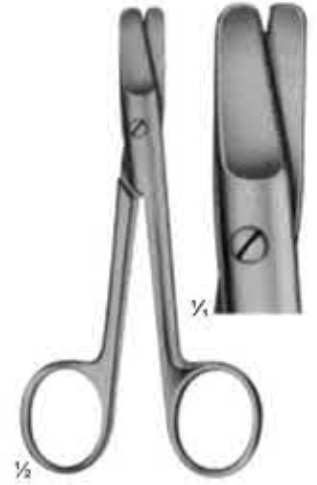

17-213
HARVEY
125 mm

0,4 mm
0,3 mm



17-214
150 mm

for soft wire
up to diam
for hard wire
up to diam

1,5 mm
1,0 mm



17-215
160 mm

1,5 mm
1,2 mm



17-216
140 mm
DUROTIP
1,5 mm

1,0 mm

Wire Cutting Pliers, Lateral Cutting Action



17-217
180 mm

for soft wire
 up to diam. 2,0 mm
 For hard wire 1,5 mm
 up to diam
 specially hardened
 cutting edges, front
 and lateral cutting
 action



17-218
REILL
175 mm

for soft wire
 up to diam. 2,0 mm
 For hard wire 1,6 mm
 up to diam
 specially hardened
 cutting edges, for
 cutting off wires close
 to the bone



DUROTIP

17-219
235 mm

for soft wire
 up to diam. 3,0 mm
 For hard wire 2,2 mm
 up to diam

Wire Cutting Pliers, Lateral and Front Cutting Action



17-220
240 mm

for soft wire
up to diam. 2,0 mm
For hard wire
up to diam 1,6 mm



17-221
145 mm

for soft wire
up to diam. 1,5 mm
For hard wire
up to diam 1,0 mm



17-222
145 mm

for soft wire
up to diam. 2,0 mm
For hard wire
up to diam 1,5 mm



17-223
220 mm

for soft wire
up to diam. 3,5 mm
For hard wire
up to diam 2,5 mm

Wire Cutting Pliers



17-224
 320 mm

for soft wire
 up to diam. 3,0 mm
 For hard wire
 up to diam. 3,0 mm



Cutter for cutting off
 KIRSCHNER wires,
 Tibia head screws,
 bolts, pins, up to 3 mm diam.



DUROTIP

17-225
 Cutter for cutting off
 KIRSCHNER wires,
 Tibia head screws,
 bolts, pins, up to 6 mm diam.
 470 mm

Finger Nail Instruments

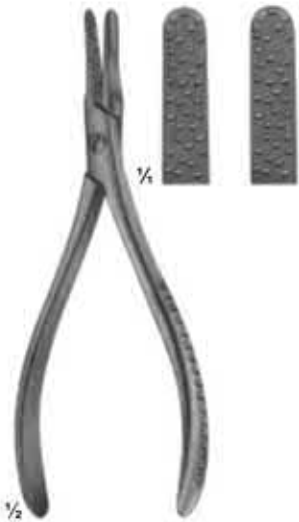

17-226
 Nail extracting
 forceps
 135 mm



17-227
 Nail extracting
 forceps
 145 mm



17-228
 Finger nail drill
 with 3 drill points

17-228 **17-229** **17-230**
 Drill points only

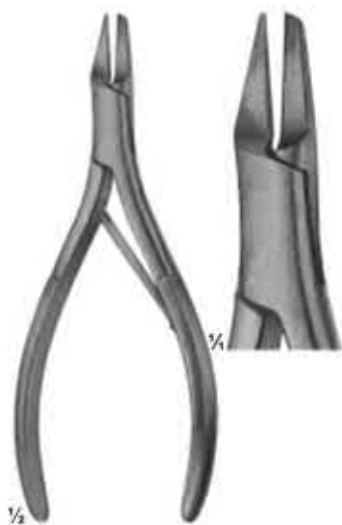

17-231
 Nail splitting
 forceps
 135 mm



17-232
 SYSTRUNK
 Scissors, for splitting
 finger nails
 130 mm



17-233
 Finger ring saw
 150 mm

Spare blade
 17-234

Plaster Shears



17-235
STILLE-AESCULAP
260 mm



17-236
STILLE-AESCULAP
360 mm

Plaster Spreader, Plaster Breakers



17-237
 HENING
 270 mm



17-238
 MOD. USA
 230 mm



17-239
 290 mm



with removable jaws



17-240 - 17-241
 WOLFF
 17-240 180 mm
 17-241 240 mm
 plaster breakers

Vacuum Curettes for Aspiration Lipectomy, Suction Instruments

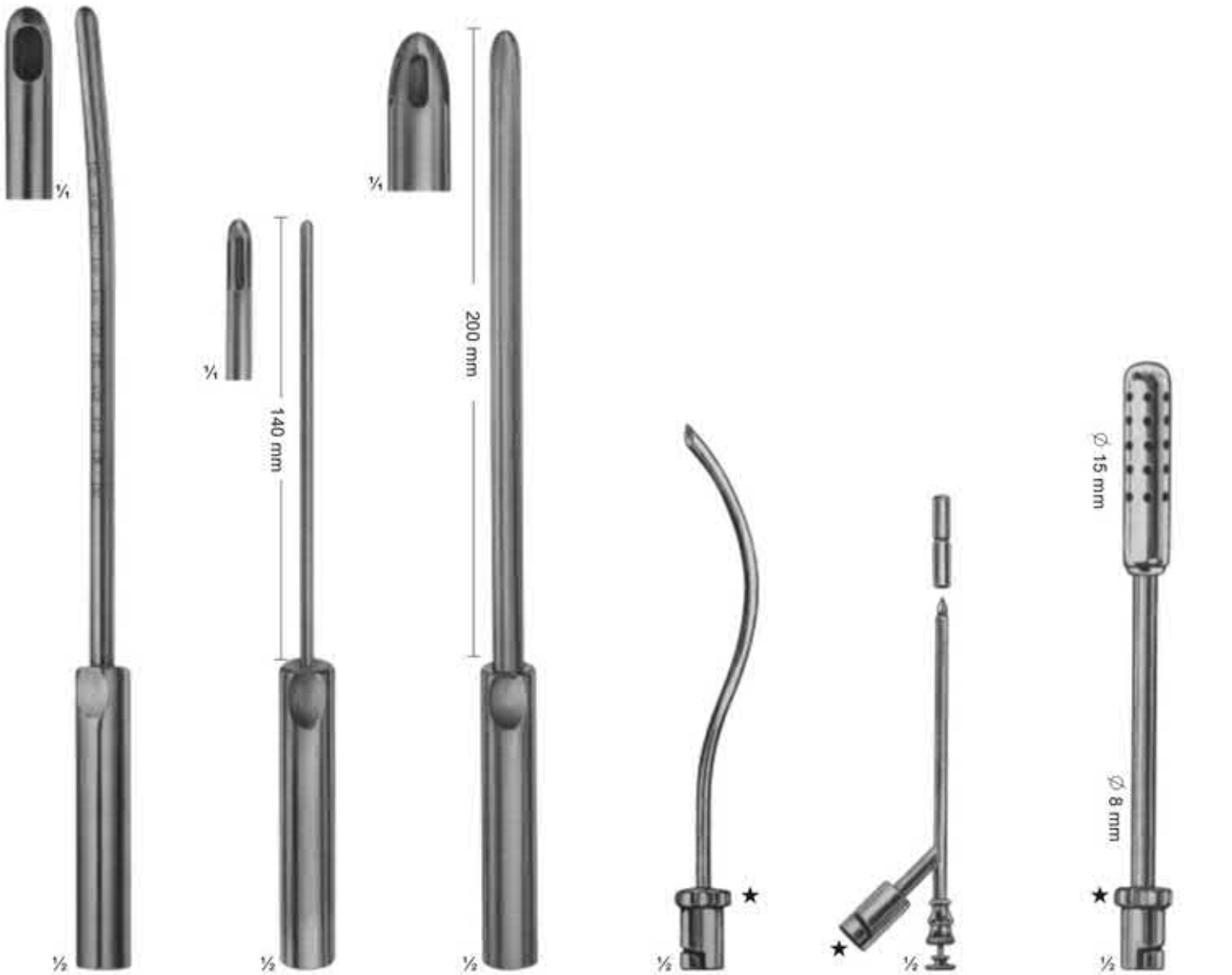

18-101 - 18-106

BIEMER

18-101 \varnothing 4 mm

18-102 \varnothing 6 mm

18-103 \varnothing 8 mm

18-104 \varnothing 10 mm

18-105 \varnothing 12 mm

18-106 \varnothing 14 mm

Curettes for aspiration lipectomy, graduated, slightly curved

18-107 - 18-108

BIEMER

18-107 \varnothing 4 mm

18-108 \varnothing 6 mm

Curettes for aspiration lipectomy, with three apertures, slightly curved malleable

18-109 - 18-111

BIEMER

18-109 \varnothing 8 mm

18-110 \varnothing 10 mm

18-111 \varnothing 12 mm

Curettes for aspiration lipectomy, with three apertures, slightly curved malleable

18-112

For aspirating fluid from the excretory ducts of large glands and for keeping the operating area clear 170 mm

18-113

Trocar

For puncturing 150 mm

18-114

For clearing large quantities of fluid 190 mm

Suction Instruments

18-115 150mm
 Suction handle, with vacuum regulator and finger cut-off, brass, mirror-finish chromium-plated



olive
 Ø 9 mm

18-116 170mm
 Suction handle, with hand regulation valve and quick-shutter, brass, mirror-finish chromium-plated



Both suction handles have bayonet fitting olive and can be used for the suction cannulae. Ø 9 mm



18-117
 Trocar
 For puncturing
 170 mm



18-118
 Hollow needle,
 sharp
 150 mm



18-119
 double curved
 For general
 surgery
 230 mm



18-120
 For tonsillectomy,
 oral and laryngeal
 operations
 190 mm



18-121
 For tonsillectomy,
 oral and laryngeal
 operations
 220 mm

★ With bayonet fitting to be used with suction handles (18-115 - 18-116)

Suction Instruments

18-122
WULLSTEIN
Suction tube, conical, silver, olive
with LUER hub
160 mm



18-123 1,5 mm
18-124 2,0 mm
WULLSTEIN
Suction tube, cylindrical, silver, with
stylet olive with LUER hub
160 mm



Usable length

YASARGIL usable length diam.		YASARGIL usable length diam.	
18-125	130 mm 1,5 mm	18-133	130 mm 2,5 mm
18-126	150 mm 1,5 mm	18-134	150 mm 2,5 mm
18-127	180 mm 1,5 mm	18-135	180 mm 2,5 mm
18-128	220 mm 1,5 mm	18-136	220 mm 2,5 mm
18-129	130 mm 2,0 mm	18-137	130 mm 3,5 mm
18-130	150 mm 2,0 mm	18-138	150 mm 3,5 mm
18-131	180 mm 2,0 mm	18-139	180 mm 3,5 mm
18-132	220 mm 2,0 mm	18-140	220 mm 3,5 mm
		18-141	180 mm 4,5 mm

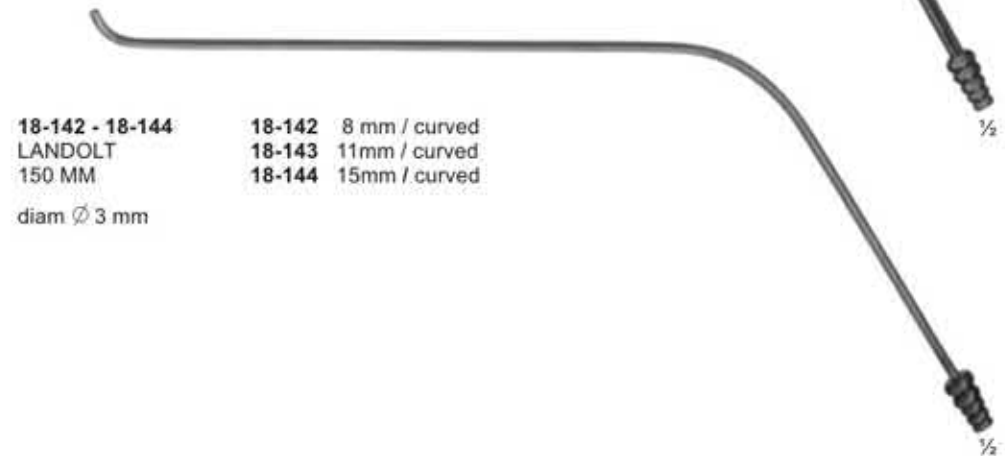

18-142 - 18-144
LANDOLT
150 MM
diam \varnothing 3 mm

18-142 8 mm / curved
18-143 11mm / curved
18-144 15mm / curved



18-147 2,0 mm diam
18-148 2,5 mm diam
18-149 3,0 mm diam
with finger cut-off,
thumb piece 90° to
curve, with LUER hub
250 mm



Combined Suction and Irrigation Cannulae, Coagulation Suction Cannulae



18-150
FINSTERER
320 mm

olive Ø 9-13 mm ½



18-151
YASARGIL
LUER-LOCK cone
200 mm

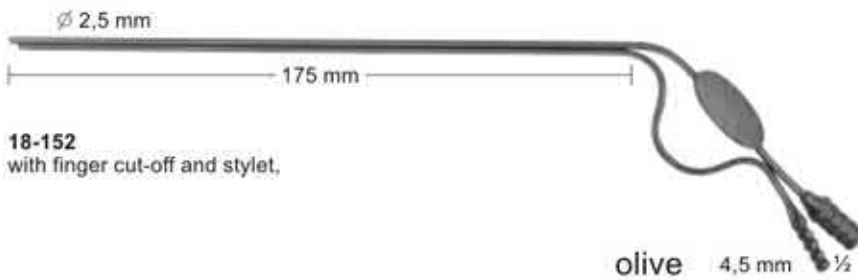

18-152
with finger cut-off and stylet,

olive 4,5 mm ½

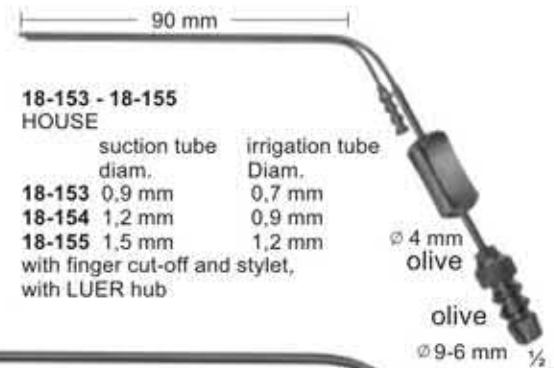

18-153 - 18-155
HOUSE

	suction tube diam.	irrigation tube Diam.
18-153	0,9 mm	0,7 mm
18-154	1,2 mm	0,9 mm
18-155	1,5 mm	1,2 mm

with finger cut-off and stylet,
with LUER hub

olive Ø 4 mm
olive Ø 9-6 mm ½



18-156 3,5 mm
with LUER-LOCK cone

olive Ø 9 mm ½



18-157 Ø 5.0 mm
LANDOLT
with finger cut-off and
stylet, can be sterilized
in an autoclave up to 3 bar (143 °C)

Connection for
suction hose

olive Ø 7,5-12 mm

4 mm diam., Untarnished
contact to be touched by
HF-electrodes

Suction Instruments

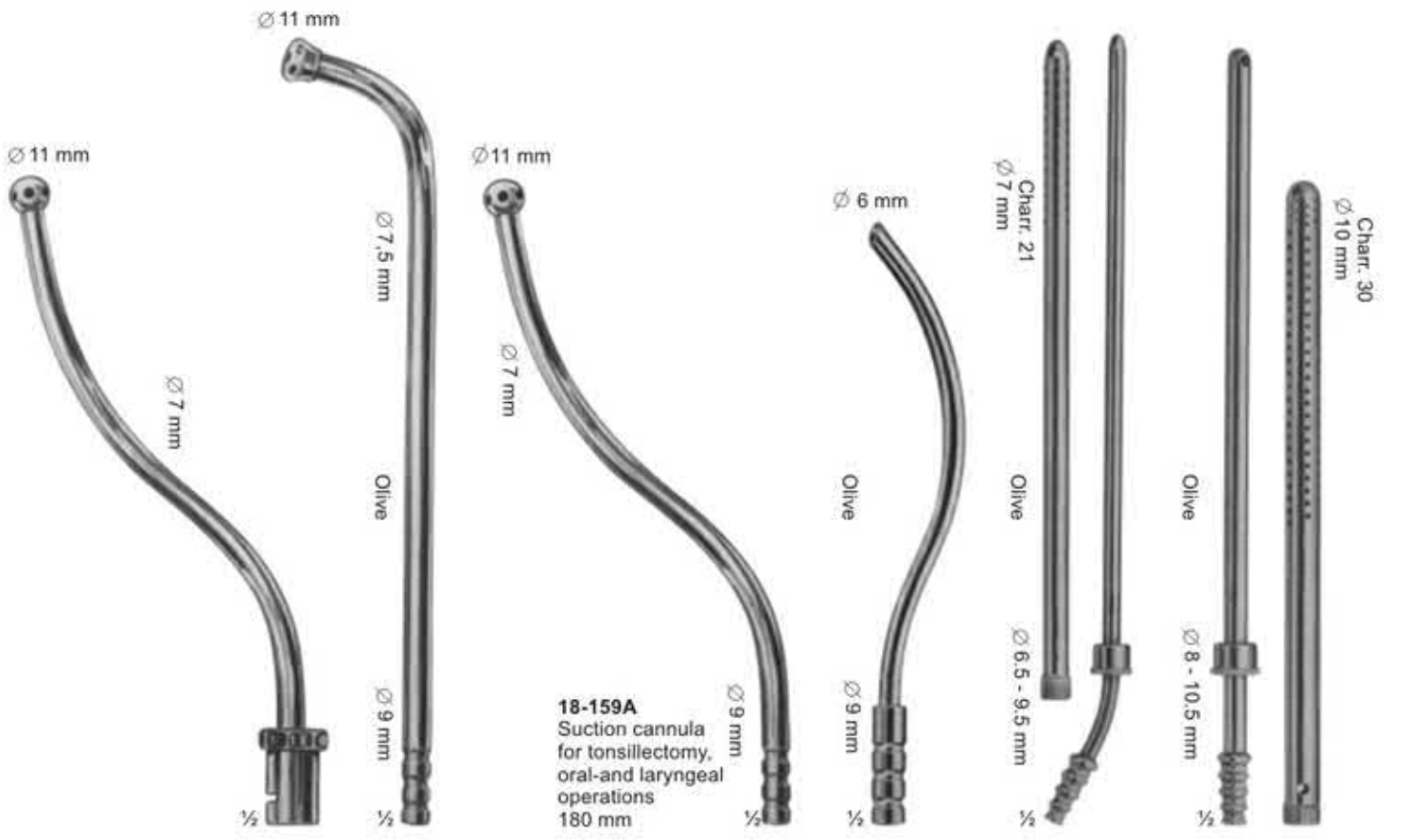

18-158
 For tonsillectomy,
 oral-and laryngeal
 operations
 180 mm

18-159
 Suction cannula
 for tonsillectomy,
 oral-and laryngeal
 operations
 220 mm

18-159A
 Suction cannula
 for tonsillectomy,
 oral-and laryngeal
 operations
 180 mm

18-160
 S-shaped blunt cannula
 for aspirating fluid from
 the excretory ducts of
 large glands and for
 keeping the operating
 area clear
 170 mm

18-161
 POOL
 Suction cannula,
 with outer tube
 to be screwed off
 225 mm

18-162
 POOL
 Suction cannula,
 with outer tube
 to be screwed off
 225 mm

Suction Instruments

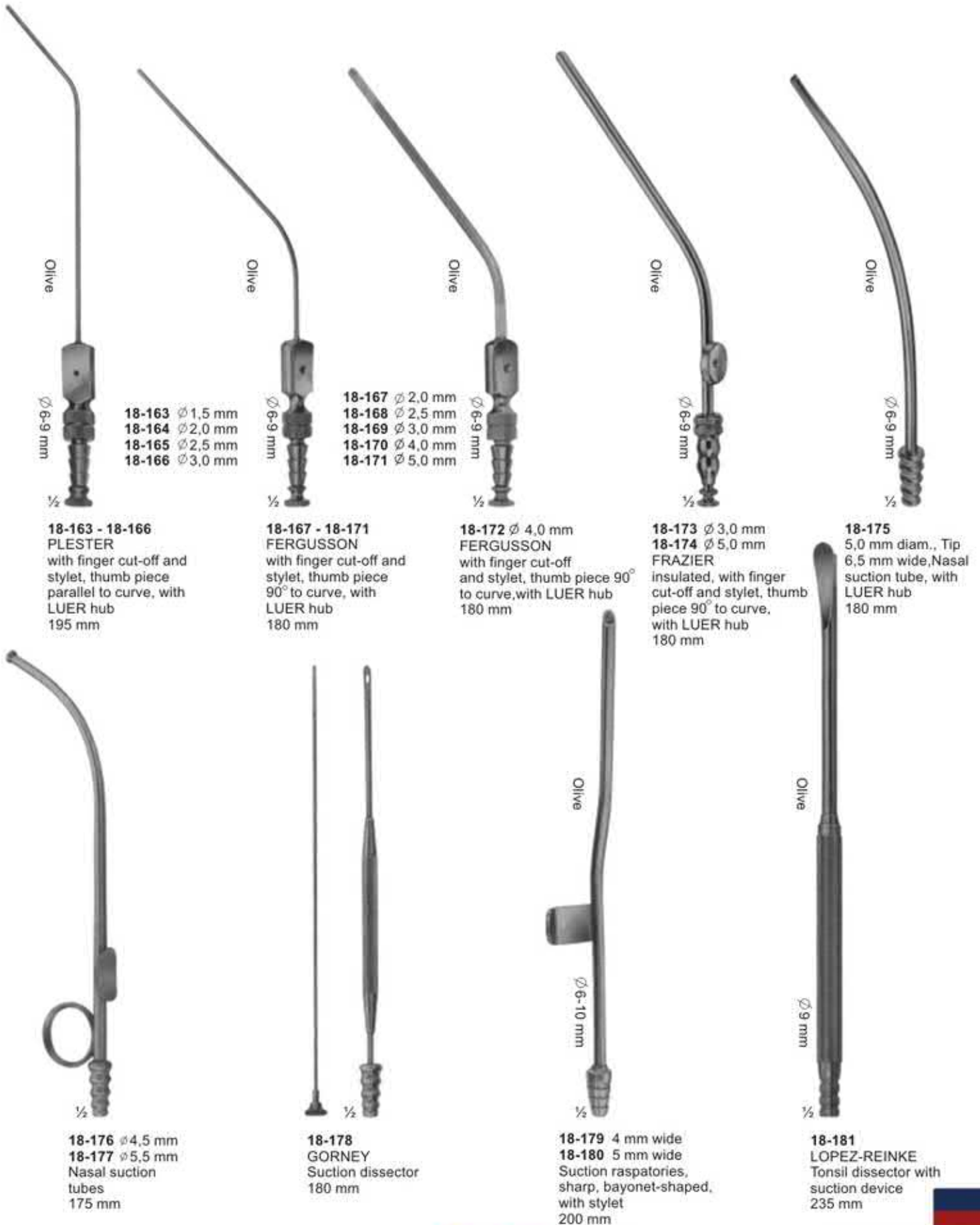

Dissection Instruments



18-182

- 1- Blow pipe .
- 2- 3 PCS .scalpel,
- 3- Dissecting forcep 13 cm.
- 4- Grooved director with tounge tie 13 cm.
- 5- Triple chain hook.
- 6- Dressing scissors probe pointed 13 cm.
- 7- Probe double 13 cm.
- 8- Zipper case inside red velvet.



18-183

- 1- Probe Double 13 cm
- 2- 2 PCS. Scalpel S.S
- 3- Grooved Director With tongue Tie 13 cm
- 4- Mayo Hegar Needle Holder 13cm
- 5- Discting Forcep 13 cm 1x2 Teeth
- 6- Dressing Forcep 13 CMS Serrated.
- 7- Dressing Scissor 13 cm S/B STR.
- 8- Dressing Scissor 13 cm S/B CVD,
- 9- Zipper Case Inside Red Velvet.

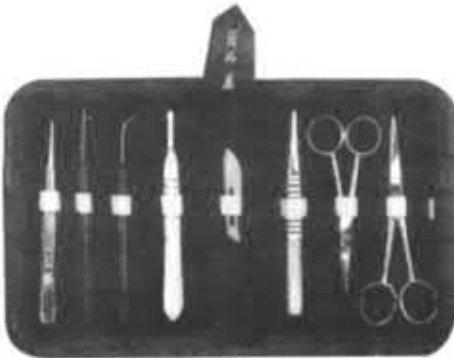

18-184

- 1- Dissecting Forcep 11.5 cm Sharp Point.
- 2- Iris Scissor
- 3- B.P Handle No. 4
- 4- Teasing Needle Sharp angular.
- 5- Blade No. 22
- 6- Thumb Forceps T.O.E 13 cm
- 7- Dissecting Scissor STR 11.5 cm
- 8- Dissecting Scissor STR 13 cm
- 9- Zipper case Inside Red Velvet

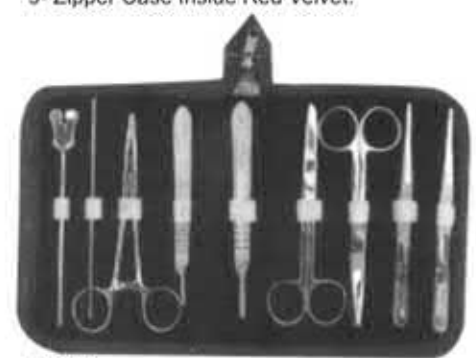

18-185

- 1- Grooved Director with Tongue Tie 14 cm
- 2- Probe Double 14cm
- 3- Mayo Hegar Needle Holder 14 cm
- 4- BP. Handle no.3
- 5- BP. Handle no.4
- 6- Dressing Scissor 14 cm S/B STR
- 7- Dressing Scissor 14 cm S/B CVD.
- 8- Dressing Forcep 1x2 Teeth 14 cm
- 9- Dressing Forcep Serrated 14 cm



18-186

- 1- Probe double 12.5 cm
- 2- Scalpel
- 3- B.P Handle No. 4
- 4- 6 PCS Blade 2 each no. 21, 22, 23
- 5- Dissecting Forcep 12.5 cm
- 6- Dissecting Forcep 11.5 cm sharp Point
- 7- Dissecting Scissor S/B STR 13 cm
- 8- Dissecting Scissor S/S STR 13 cm



18-187

- 1- Teasing Needle with Chuck CVD.
- 2- Huber Probe
- 3- Iris Scissor
- 4- Dissecting Forcep Fine 14 cm.
- 5- Dissecting Forcep Fine CVD. 12 cm
- 6- Operating Scissor with Probe 14 cm.
- 7- B.P. Handle no. 4

Dissection Instruments



18-188

- 1- Probe with eye
- 2- Dissecting Forcep cvd fine 12 cm.
- 3- Iris Scissor
- 4- Operating Scissor S/B str 14 cm
- 5- Grooved Director and Tongue tie
- 6- Huber Probe
- 7- Triple Chain Hook
- 8- B.P Handle No. 4
- 9- B.P Handle No. 3
- 10- Teasing Needle with Chuck cvd.
- 11- Teasing Needle with Chuck str.
- 12- Dissecting Forceps Fine 14 cm.

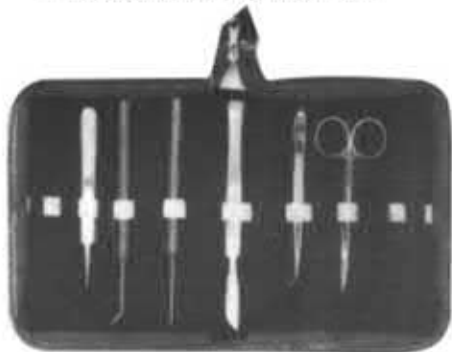

18-190

- 1- Iris Scissor STR
- 2- Dissecting Forceps CVD 12 cm.
- 3- Scalpel
- 4- Teasing Needle STR wooden handle.
- 5- Teasing Needle CVD wooden handle.
- 6- Watchmaker fine point.



18-192

- 1- Probe double end.
- 2- Grooved director and tongue tie.
- 3- B.P handle no.4
- 4- Operating scissor STR S/b14cm.
- 5- Kelly forceps STR 14cm.
- 6- Dissecting forceps thumb 13cm.

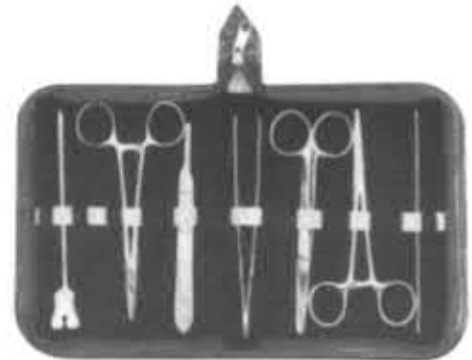

18-189

- 1- Grooved Director and Tongue tie
- 2- Mayo Hearn Needle Holder 14 cm
- 3- B.P Handle No. 4
- 4- Dissecting Forceps Thumb 14 cm.
- 5- Operating Scissor S/B str 14 cm
- 6- Kelly Forcep STR 14 cm.
- 7- Probe Double end



18-191

- 1- Probe Double end
- 2- B.P Handle No. 4
- 3- Dissecting Forcep 1x2 Teeth 14 cm.
- 4- Operating Scissor S/B str 14 cm
- 5- Mayo Hearn Needle Holder 14 cm
- 6- Kelly Forcep STR 14 cm.
- 7- Operating Scissor S/B CVD 14 cm
- 8- Grooved Director and Tongue tie
- 9- Dissecting Forceps Thumb 14 cm.

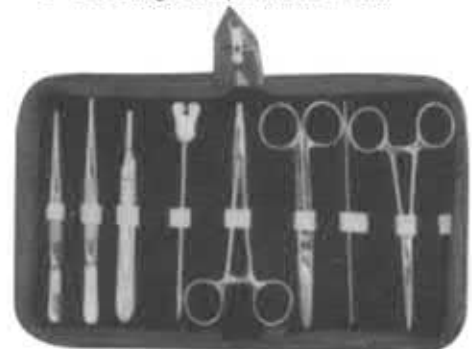

18-193

- 1- Dissecting Forceps Thumb 14 cm.
- 2- Dissecting Forcep 1x2 Teeth 14 cm.
- 3- B.P Handle No. 3
- 4- Grooved Director and Tongue tie
- 5- Mayo Hearn Needle Holder 14 cm
- 6- Operating Scissor S/B str 14 cm
- 7- Probe Double end
- 8- Kelly Forcep STR 14 cm.

Dissection Instruments



18-194

- 1- Dissecting Forcep Fine 14cm.
- 2- Dissecting Forcep Fine CVD 12cm
- 3- Dissecting Forcep with Pin 14cm.
- 4- Watchmaker Fine point
- 5- Iris scissor STR
- 6- Iris scissor CVD.
- 7- Teasing Needle holder
- 8- Teasing Needle STR.
- 9- B.P. Handle no. 3



18-195

- 1- Teasing Needle STR.
- 2- Grooved Director and Tongue Tie.
- 3- Teasing Needle CVD.
- 4- Dissecting Forcep with Pin 12 cm Fine
- 5- Operating Scissor S/B STR 14 cm
- 6- Triple Chain Hook
- 7- Probe with eye
- 8- Probe Double end
- 9- Probe and Hook
- 10- Dissecting Forcep Fine 14 cm
- 11- Iris Scissor
- 12- Huber Probe
- 13- B.P. Handle no.3
- 14- B.P. Handle no.4



18-196

- 1- Dissecting forcep fine STR with pin 12cm.
- 2- Iris scissor STR.
- 3- Probe with eye.
- 4- Probe and hook.
- 5- Operating scissor S/B STR 14cm
- 6- Triple chain hook.
- 7- B.P. handle no.4
- 8- Humber probe.
- 9- B.P.handle no.3
- 10- Teasing needle STR plastic handle.
- 11- Teasing needle CVD plastic handle.
- 12- Grooved director and tongue tie.
- 13- Probe double end.



18-197

- 1- Dissecting Forceps Thumb 14 cm.
- 2- Dissecting Forcep 1x2 Teeth 14 cm.
- 3- B.P Handle No. 3
- 4- Grooved Director and Tongue tie
- 5- Mayo Hearn Needle Holder 14 cm
- 6- Operating Scissor S/B str 14 cm
- 7- Probe Double end
- 7- Kelly Forcep STR 14 cm.

Hospital Wares



19-101 - 115
Schimmelbusch

Ø x H
sizes in mm

19-101	80 x 80
19-102	105 x 120
19-103	140 x 140
19-104	160 x 120
19-105	160 x 150
19-106	190 x 150
19-107	190 x 190
19-108	240 x 160
19-109	240 x 240
19-110	290 x 160
19-111	290 x 240
19-112	340 x 160
19-113	340 x 340
19-114	390 x 190
19-115	390 x 290



19-116
Box
120 x 65 x 13mm
(without Bulldog clamps,
without silicone tape)



19-117
Box with support
120 x 65 x 13 mm
(ohne Bulldogklemmen)



19-118
Box with support for
needle electrodes,
without instruments



19-119 - 121
50 x 25 x 4,5 mm
19-120
65 x 42 x 8 mm
19-121
75 x 25 x 4,5 mm



19-122
Ø 65mm x 15mm

Hospital Wares



19-123 - 131

	∅ x H
19-123	30 x 90 mm
19-124	50 x 100 mm
19-125	50 x 130 mm
19-126	50 x 175 mm
19-127	75 x 100 mm
19-128	75 x 130 mm
19-129	75 x 175 mm
19-130	100 x 175 mm
19-131	100 x 200 mm



19-141 - 142

- 19-141** Martin Sterilizing Forceps consisting of:
1 Sterilizing Forceps, curved, 25 cm, without ratchet, with lid for jar
1 jar with bottom plate (anti-tilt)
- 19-142** ditto, with 32 cm long Sterilizing Forceps



19-132 - 139

19-132	165 x 85 x 35 mm
19-133	200 x 100 x 35 mm
19-134	200 x 100 x 50 mm
19-135	230 x 130 x 50 mm
19-136	260 x 150 x 50 mm
19-137	270 x 235 x 50 mm
19-138	300 x 200 x 50 mm
19-139	325 x 275 x 50 mm



19-140
205 x 105 x 35 mm

Round Metal Boxes and Medicine Cups



19-143 - 148

	Ø x H
19-143	75 x 60 mm
19-144	75 x 75 mm
19-145	100 x 60 mm
19-146	100 x 100 mm
19-146A	125 x 80 mm
19-147	125 x 125 mm
19-148	150 x 150 mm



19-149
25 cc

19-150
50 cc



19-151
20 cc
Medicine Spoon



19-152
Ø 75 x 12 mm
Tablet Tray



19-153
Ø 90 x 90 mm
Metal Cup



19-154
Ø 75 x 80 mm
Sputum Cup



Kidney Dish



19-155 - 157

19-155	170 x 100 x 35 mm
19-156	250 x 140 x 40 mm
19-157	275 x 150 x 45 mm

Hospital Wares



19-158 - 165



19-166 - 170

	Ø x H		
19-158	40 x 19 mm	0.05L	
19-159	61 x 30 mm	0.07L	
19-160	80 x 40 mm	0.14L	
19-161	116 x 50 mm	0.35L	
19-162	128 x 55 mm	0.45L	
19-163	147 x 65 mm	0.70L	
19-164	167 x 75 mm	1.10L	
19-165	187 x 85 mm	1.60L	

19-166	116 x 35 mm	0.30L
19-167	128 x 38 mm	0.40L
19-168	147 x 40 mm	0.50L
19-169	157 x 45 mm	0.75L
19-170	187 x 45 mm	1.00L



19-171
 Ø 110 x 28 mm 0.15L



19-172
 100 cc 0.1L



19-173 - 176
 19-173 0,25L
 19-174 0,50L
 19-175 1,00L
 19-176 2,00L



19-177
 235 x 190 x 40 mm



19-178
 Ø 220 x 70 mm

Hospital Wares



19-179
 ∅ 50 x 100 mm
 Powder Pot



19-180
 ∅ 50 x 75 mm
 Methot With Lid



19-181
 ∅ 50 x 75 mm
 Methot Without Lid



19-182



19-183



19-184



19-185 - 186

19-185 ∅ 235 mm
19-186 ∅ 310 mm

Needle Cases



19-187
 Sauerbruch
 210 x 125 x 17 mm



19-188
 Sauerbruch
 210 x 125 x 17 mm



19-189
 Instruments Tray



19-190
 150 x 95 x 13 mm



19-191
 150 x 95 x 13 mm



19-192
 150 x 95 x 13 mm



19-193
 Instruments Tray



19-194
 Instruments Tray



19-195
 150 x 95 x 11 mm

Storing Cases



19-199 - 209

19-199	230 x 130 x 50	mm
19-200	260 x 150 x 50	mm
19-201	275 x 235 x 50	mm
19-202	300 x 200 x 50	mm
19-203	325 x 275 x 50	mm
19-204	420 x 175 x 50	mm
19-205	230 x 130 x 75	mm
19-206	260 x 150 x 75	mm
19-207	300 x 200 x 75	mm
19-208	325 x 275 x 75	mm
19-209	420 x 175 x 75	mm



19-196
 Deponette
 245 x 135 x 35mm



19-197
 Deponette
 245 x 135 x 50mm



19-198
 Deponette
 245 x 135 x 60mm

Sterilizing Baskets / Trays



19-210 - 212

19-210	480 x 250 x 50	mm
19-211	520 x 250 x 75	mm
19-212	520 x 250 x 100	mm



19-219
 (60 x 30 x 15 cm)
 Nominal dimensions



19-213 - 218

19-213	240 x 240 x 50	mm
19-214	240 x 240 x 80	mm
19-215	240 x 240 x 100	mm
19-216	480 x 260 x 50	mm
19-217	520 x 260 x 80	mm
19-218	520 x 260 x 100	mm

Scissors with Tungsten Carbide Inserts



26-101
Standard

14,5cm
16,5cm
18,5cm



26-102
Standard

14,5cm
16,5cm
18,5cm



26-103
Standard

14,5cm
16,5cm
18,5cm



26-104
Standard

14,5cm
16,5cm
18,5cm



26-105
Standard

14,5cm
16,5cm
18,5cm



26-106
Standard

14,5cm
16,5cm
18,5cm

Scissors with Tungsten Carbide Inserts

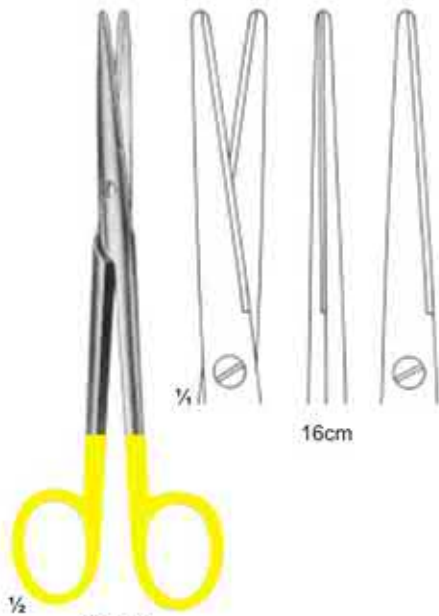

1/2
26-107
 Mayo-Lexer

16cm

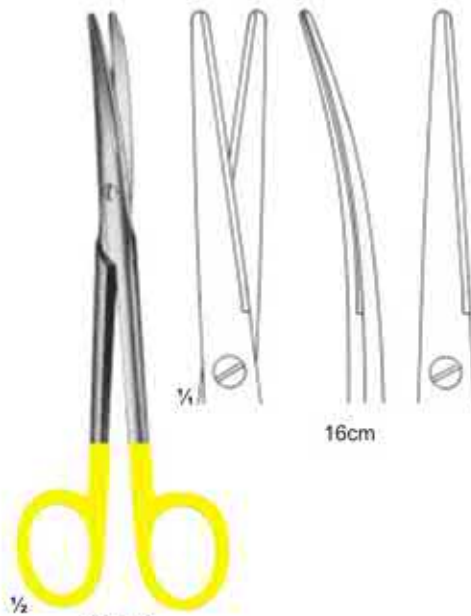

1/2
26-108
 Mayo-Lexer

16cm

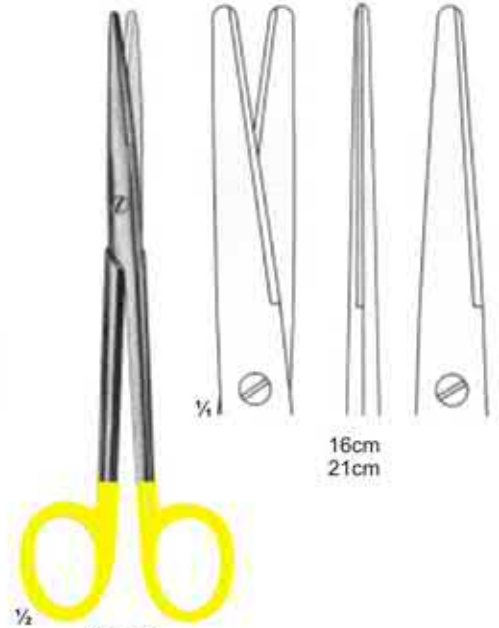

1/2
26-109
 Lexer

16cm
 21cm

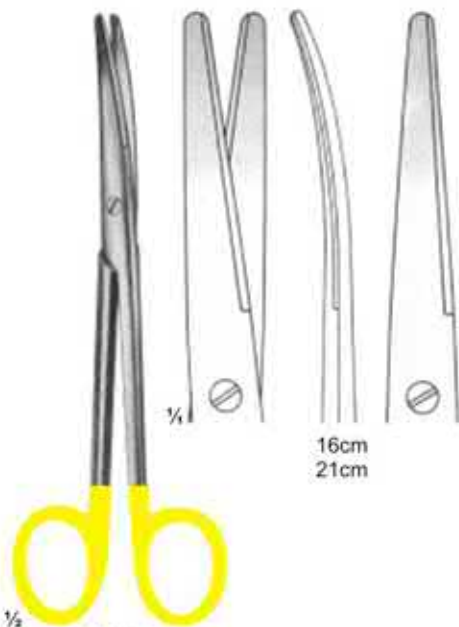

1/2
26-110
 Lexer

16cm
 21cm

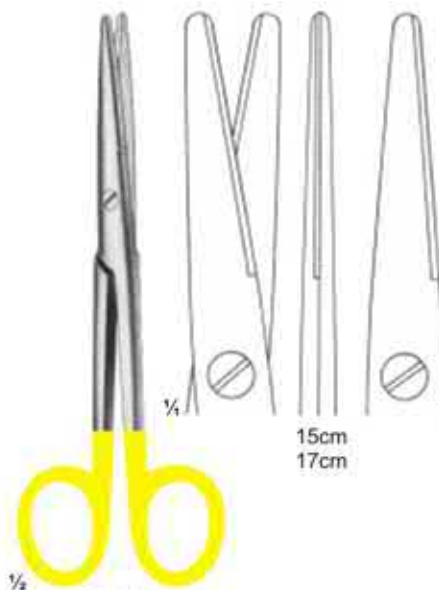

1/2
26-111
 Mayo-Stille

15cm
 17cm

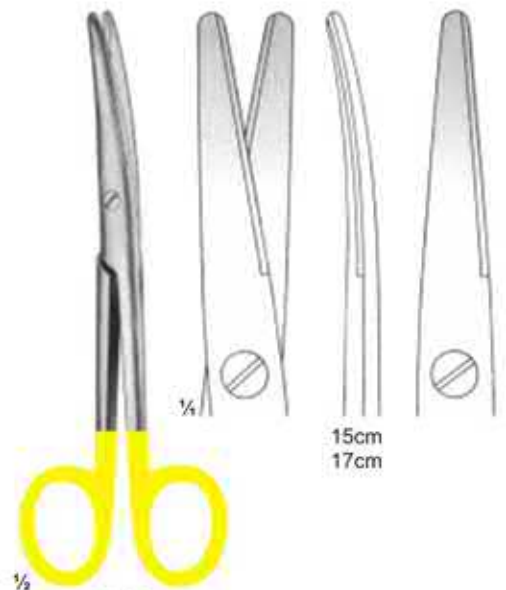

1/2
26-112
 Mayo-Stille

15cm
 17cm

Scissors with Tungsten Carbide Inserts

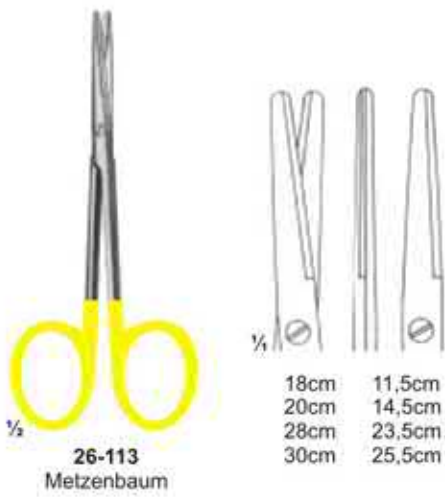

Scissors with Tungsten Carbide Inserts



1/2
26-119
 Metzenbaum-Fino

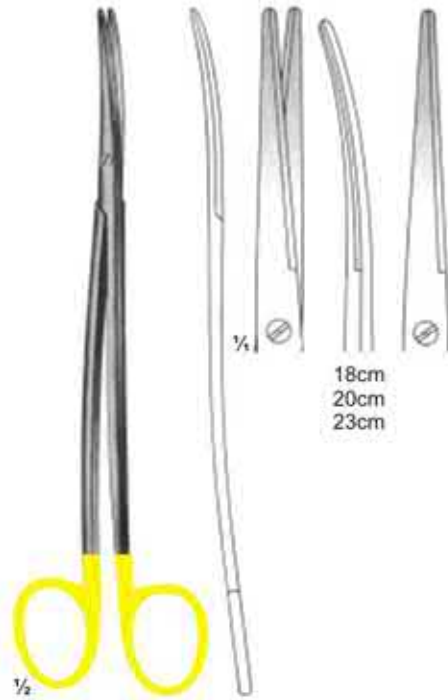

1/2
26-120
 Metzenbaum-Fino

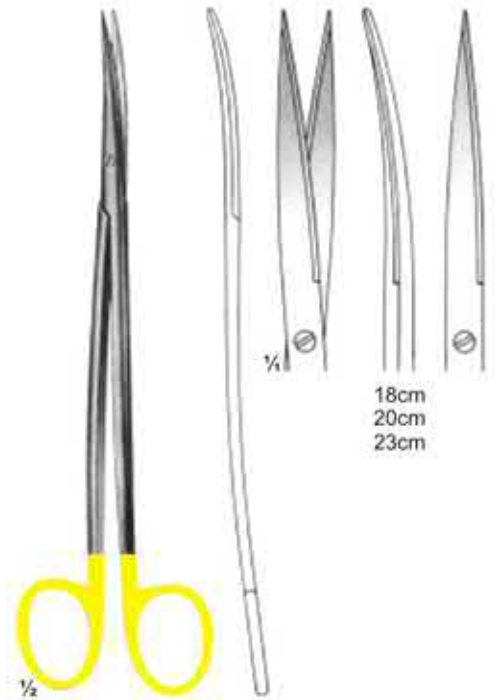

1/2
26-121
 Metzenbaum-Fino

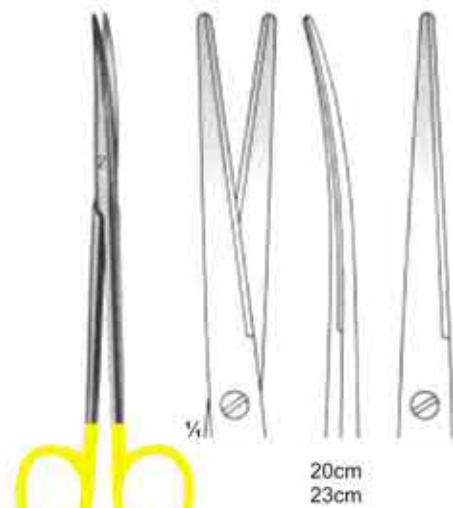

1/4
26-122
 Metzenbaum

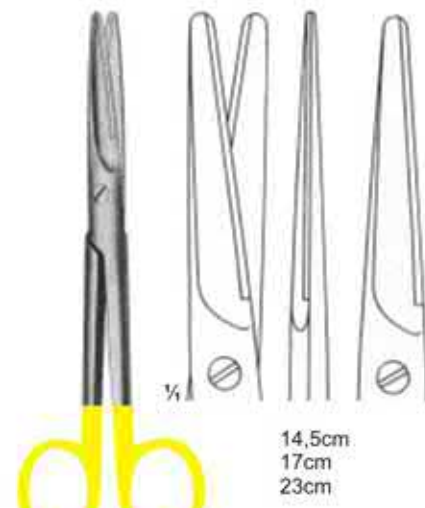

1/4
26-123
 Mayo

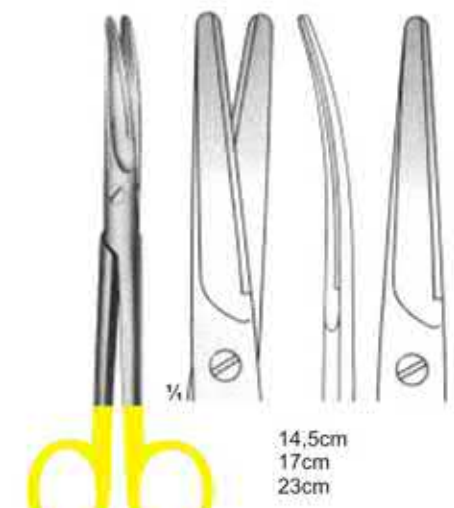

1/4
26-124
 Mayo

Scissors with Tungsten Carbide Inserts

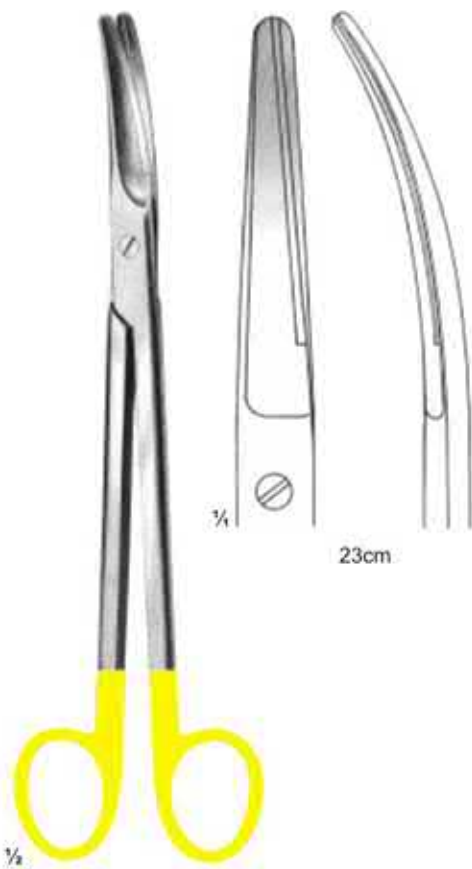

26-125
Parametrium

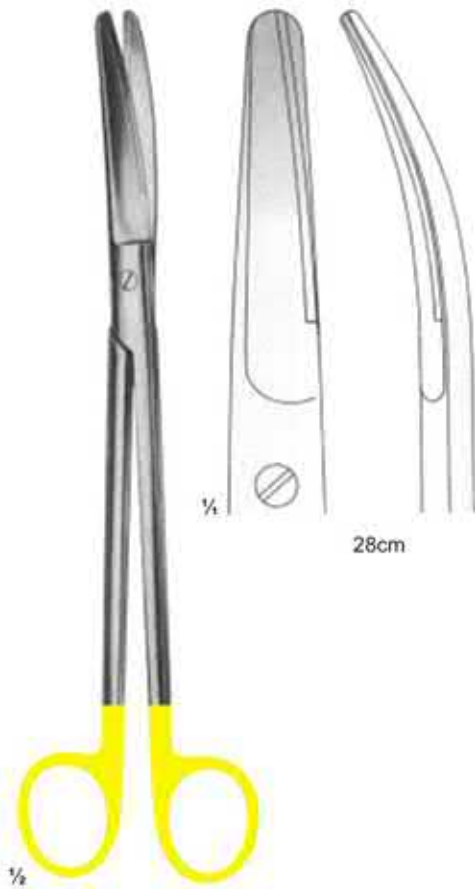

26-126
Mayo-Harrington

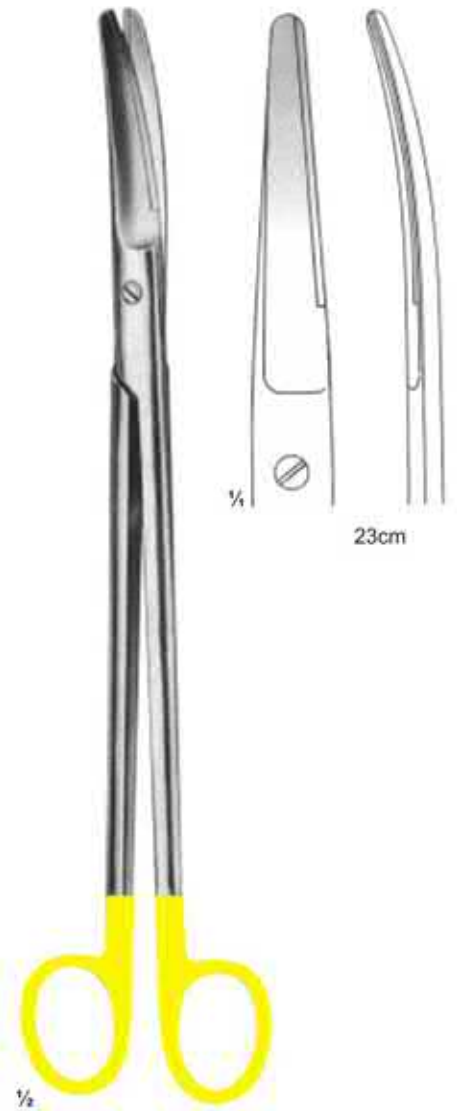

26-127
Sims

Scissors with Tungsten Carbide Inserts

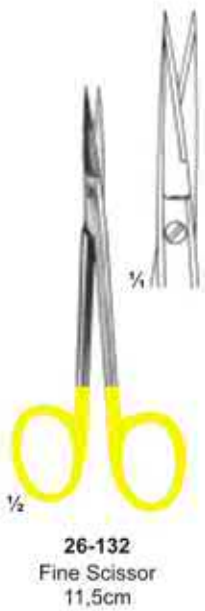
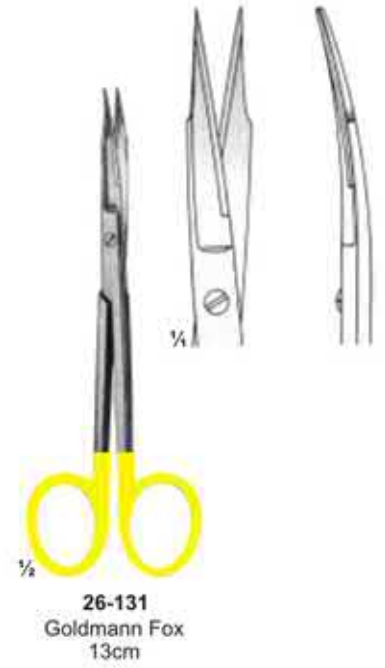

Scissors & Dissecting Forceps with Tungsten Carbide Inserts



26-136
 Universal
 12cm



26-137
 Ligature Scissors
 1 Black & 1 Goldplated ring

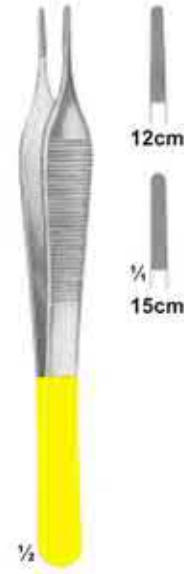

26-138
 Adson



26-139
 Cushing
 17,5cm



26-140
 Cushing
 18cm



26-141
 Cushing-Taylor
 18cm



26-142
 Dissecting Forceps
 15cm



26-143
 Semken
 15cm

Dissecting Forceps and Needle holders with

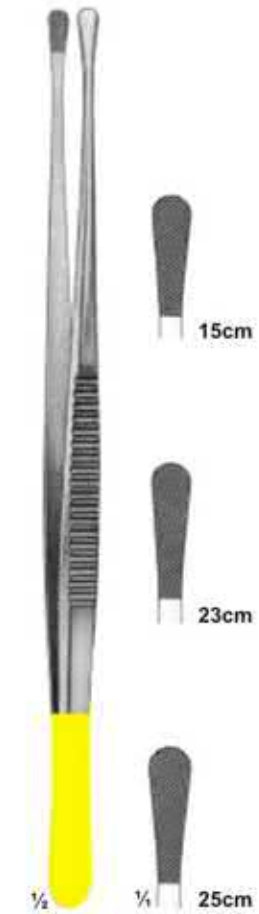

26-144
 Wangenstein

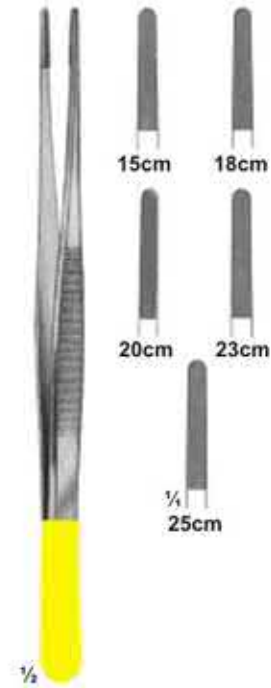

26-145
 Potts-Smith

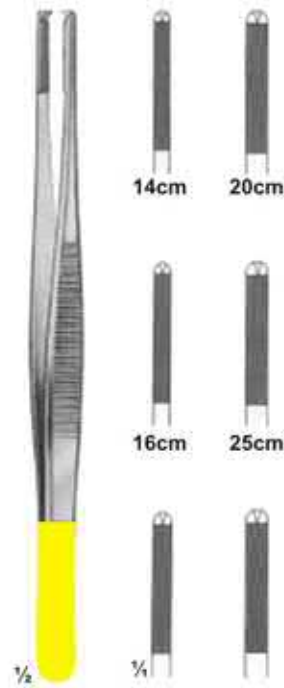

26-146
 Oehler



26-147
 Potts-Smith
 22cm



26-148
 Hepp-Scheidle
 18cm



26-149
 Castroviejo
 14cm



26-150
 Castroviejo
 14cm



26-151
 Arruga
 16cm

Needle holders with Tungsten Carbide Inserts



26-152
 Arruga
 16cm



26-153
 Castroviejo
 13cm



26-154
 Hegar
 20cm 24cm

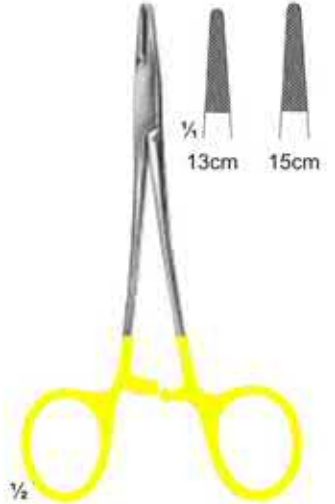

26-155
 Halsey
 13cm 15cm



26-156
 Mayo-Hegar
 16cm 18cm 20cm
 24cm 26cm 30cm



26-157
 De-Bakey
 18cm 20cm 23cm
 26cm 31cm 37cm

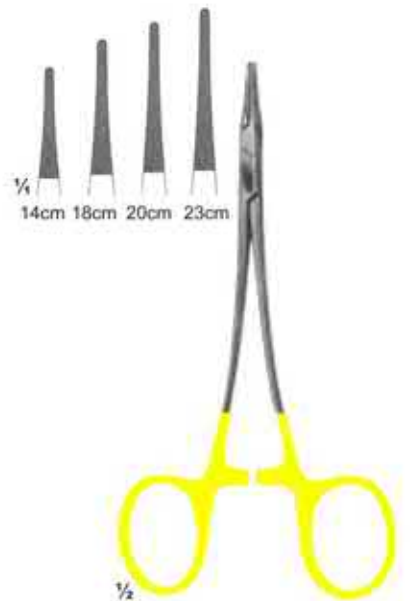

26-158
 Hegar-Vascular
 14cm 18cm
 20cm 23cm

Needle holders with Tungsten Carbide Inserts



1/2
26-159
 Bozemann-Wertheim
 20cm 24cm 26cm



1/4
26-160
 Stratte
 22cm 23cm

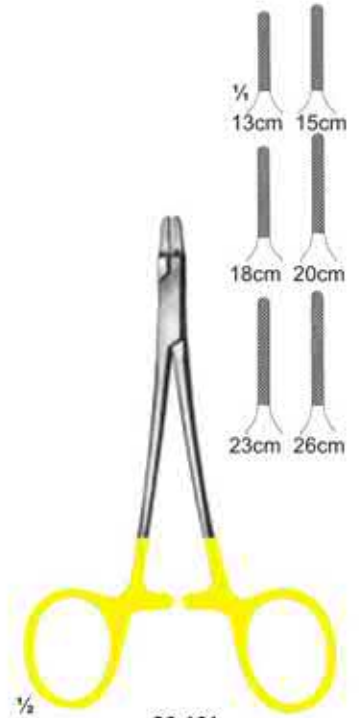

1/2
26-161
 Ryder
 13cm 15cm 18cm
 20cm 23cm 26cm



1/2
26-162
 Ryder-Vascular
 13cm 15cm 18cm
 20cm 23cm 26cm



1/4
26-163
 Martin
 15cm 17cm 20cm



1/4
26-164
 Sarot
 18cm 20cm 26cm

Needle holders with Tungsten Carbide Inserts



Needle holders with Tungsten Carbide Inserts



26-172
 Mathieu-Ryder
 17cm
 20cm 24cm



26-173
 Lichtenberg
 20cm



26-174
 Langhals
 20cm 25cm



26-175
 Lichtenberg
 20cm 25cm



26-176
 Luehty-Beck
 20cm 25cm



26-177
 Luehty-Beck
 20cm 25cm



26-178
 Langebeck
 18cm
 20cm 23cm

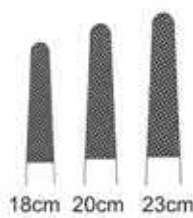

26-179
 Langebeck-beck
 18cm
 20cm 23cm

Wire Cutting Plier With T.C. Inserts



26-180
TOENNIS
 Elastic pattern for
 dura-or intestinal suture
 180 mm



26-181
 Cutting Plier
 12 cm

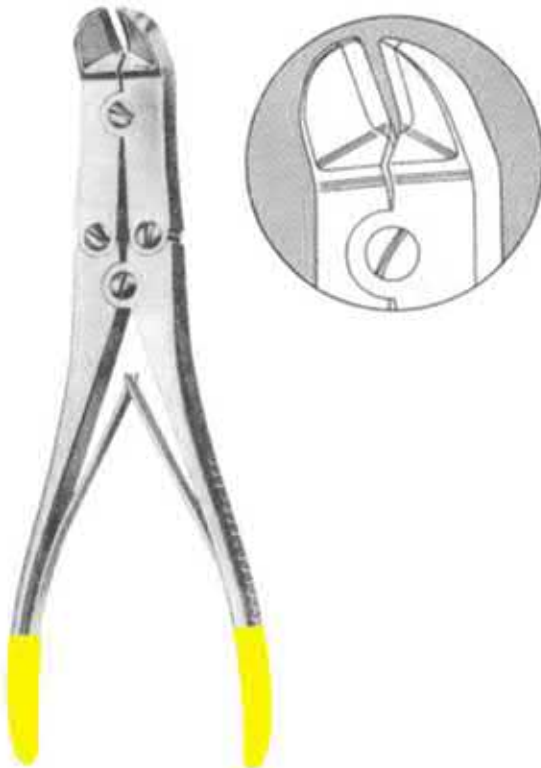

26-182
MULLAR CLAUS
 22 cm



26-183
 Plier
 17.5 cm

Alphabetical Index

A	
ABRAHAM, tonsil knife	13
ADSON, forceps	33
ADSON, forceps	37
ALLIS, artery traction forceps	47
ALLIS, intestinal grasping forceps	86
ALY, aesthesiometer	01
AMPUTATING KNIVES	12
ANDREW, tongue depressor	04
ANESTOPHON, stethoscope	02
ARRUGA, forceps	37
ARRUGA, needle holder	61
ASCH, biopsy curettes	112
AUFRIEHT, rasps	138
AYRE, cone knife, 235mm	13
ADSON - BROWN, Tissue Forceps	39
ADSON, Haemostatic Forceps	52
ANGLE, Wire Cutters Cutting Scissors	151
B	
BABCOCK, intestinal grasping forceps	86
BABY-ALLIS, artery traction forceps	47
BACKHAUS, towel clamps	48
BACKHAUS-KOCHER, towel clamps	48
BAILEY, rib spreaders	128
BAKES, gall duct dilators	95
BALFOUR, abdominal retractors	85
BALFOUR-BABY, abdominal retractors	84
BANE-HARTMANN, bone rongeurs	144
BARTH, bone curettes	139
BABY-MOSQUITO, Haemostatic Forceps	51
BABY-ROUX, Retractors	73
BABY-SENN-MILLER, Retractors	73
BEEBE wire scissor	29
BEER, cilia forceps	42
BENGOLEA, delicate forceps	50
BERGER, biopsy forceps	115
BERLINER, percussion hammer	01
BENDING PLIERS, Wire Holding forceps	150
BERTILLON, Examination & Measuring Instruments	10
BIEMER, vein scissor	16
BISHOP-HARMON, forceps	37
BIEMER, Suction Instruments	158
BLAKE, gall stone forceps	96
BLUMENTHAL, bone rongeurs	144
BONNEY, tissue forceps	41
BOSE, tracheal hooks	119
BOWLES, stethoscope	02
BOYS-ALLIS, artery traction forceps	47
BOZEMANN, dressing forceps	108
BOYNTON, Needle Holders	47
BRAUN, artery traction forceps	107
BRAUN, uterine probes	28
BRAUN-STADLER episiotomy scissor	31
BRAUN-STADLER, bandage scissors	102
BRIESKY, vaginal specula	66
BRODIE, probes	34
BROPHY, dissecting forceps	04
BRUENINGS, tongue depressor	13
BRUNINGS, tonsil knife, 215mm	76
BRUNNER, retractors	126
BRUNNER, rib shears	31
BRUNS, plaster scissor	64
BRYANT, sponge forceps	43
BROPHY, Tissue Forceps	38
BROWN, Tissue Forceps	39
BUCHS, retractors	75
BUCHWALD, tongue depressor	04
BUCK, neurological hammer	01
BUMM, ovum forceps	230
BUCK, Ear Curettes	110
C	
CASPAR, retractor	75
CASPAR, Micro scissor 115mm	16
CASTROVIEJO, tissue forceps	37
CASTROVIEJO, micro spring scissor	15
CASTROVIEJO, needle holder	61
CASTROVIEJO, eye scissor 110mm	15
CASTROVIEJO, eye scissor 115mm	15
CATLIN, amputating knife 160mm	12
CALIPER, Examination & Measuring Instruments	10
CARREL, Haemostatic Forceps	51
CARROLL, Examination & Measuring Instruments	10
CASPAR, Rongeurs	133
CASPAR, Rongeurs	134
CASTROVIEJO, Examination & Measuring Instruments	10
CHAPUT, artery traction forceps	47
CLOWARD, lamina Spreaders	83
CLAUS PLIER, Wire Cutting Plier With T.C. Inserts	187
CLAUS PLIER, Wire Cutting Plier With T.C. Inserts	187
COAKLEY, antrum trocars	100
COLLIN, intestinal grasping forceps	86
COLLIN, rib shears	126
COLLIN, sponge and dressing forceps	44
COLLIN, tongue forceps	05
COLLIN, vaginal spatula	101
CONE KNIFE 235mm11	13
CONVERSE, fine wound retractor	69
COOLEY, multi purpose clamps	122
COTTLE, retractors	71
COTTLE, nasal scissor	25
COTTLE, fine wound retractor	69
COTTLE, mallets	140
COLLIN, Examination & Measuring Instruments	10
COLLIN, Intestinal Grasping Forceps	46
COLLIN, Retractors	73
COLLIN-HARTMANN, Retractors	73
COTTLE, Forceps, Bayonet - Shaped	40
COTTLE, Nasal Specula	91
CRILE, Haemostatic Forceps	52
CRILE, Haemostatic Forceps	52
CRILE, Retractors	73
CUTTING PLIER, Wire Cutting Plier With T.C. Inserts	187
CRAFOORD, haemostatic forceps	50
CRILE, needle holder	63
CUSCO, vaginal specula	101
CUSHING, wound and vein retractor	71
CUSHING, dissecting forceps	34
CUSHING-KOCHER, retractors	71
CZERNY, gall stone forceps	96
CZERNY, retractors	72

Alphabetical Index

D		F	
DAVIDSON, scapula retractors	77	FARABEUF, Retractors	73
DAVIS, vascular spatulas	120	FEILCHENELD, splinter forceps	42
DANDY, Haemostatic Forceps	51	FERGUSSON, haemorrhoidal forceps	93
DE BAKEY, forceps	36	FERGUSSON, suction instrument	163
DE BAKEY, anastomosis clamps	89	FERGUSSON-ACKLAND, mouth gag	05
DE BAKEY, anastomosis clamps	125	FINOCHIETTO, forceps	58
DE BAKEY, arteriotomy scissor	22	FINOCHIETTO, rib spreader	127
DE BAKEY, vana cava clamps	123	FINSEN, tracheal hooks	119
DE BAKEY, multi purpose clamps	122	FIBER OPTIC, laryngoscopes	09
DE BAKEY, retractors	82	FINGER NAIL DRIL, Finger Nail Instruments	155
DE BAKEY, atraumata	121	FINGER RING SAW, Finger Nail Instruments	155
DEAN, nasal and tonsil scissor	25	FINSTERER, Suction Instruments	161
DEAVER, retractors	77	FLAT-NOSED PLIERS, Wire Holding forceps	150
DEAVER, surgical scissor (flat lock)	21	FOERSTER-BALLENGER, Tissue Grasping Forceps	45
DE-BAKEY, bulldog clamps	49	FORCEPS, Finger Nail Instruments	155
DEJERINE, percussion hammer	01	FOREGGER, laryngoscopes	09
DELICATE DISSECTING FORCEPS	33	FOMON, nasal scissor	19
DELICATE SCISSORS, blunt points	19	FORD-BOWLES, stethoscope	02
DELICATE SCISSORS, sharp points	18	FOWLER, tonsil knife	13
DELICATE SCISSORS, sharp points	19	FRANCKE, blood lancet	06
DENHARDT, mouth gag	05	FRAZIER, fine wound retractor	69
DENIS-BROWENE, intestinal forceps	41	FRAZIER, suction instruments	163
DERRA, multi purpose clamps	122	FREER, fine wound retractor	69
DESCHAMPS, ligature needles	65	FREER, vascular spatulas	120
DESJARDINS, gall duct forceps	95	FRENZEL, tongue depressor	04
DESJARDINS, gall stone forceps	96	FRICKE, haemostatic forceps	56
DESJARDINS, gall stone scoops	95	FRITSCH, retractor	79
DESMARRES, wound and vein retractors	71		
DEMEL, Cerclage Instruments	148	G	
DIAGNOSTIC SETS	07	GALLAHER, rasp	126
DICK, vaginal clamps and compression forceps	59	GELPI, special retractors	82
DIEFFEBACH, bulldog clamps	49	GELPI, vaginal retractors	105
DINGMANN, bone holding forceps	142	GERALD, dissecting forceps	34
DISSECTING KNIVES	11	GIERTZ-STILLE, rib shears	126
Dissection Instruments	164	GILL, tissue forceps	37
Dissection Instruments	165	GILL-HESS, tissue forceps	37
Dissection Instruments	166	GILLIES, fine wound retractor	69
DITTEL, metal bougies	80	GILLIES, needle holder	63
DOYEN, abdominal retractors	79	GLOVER, bulldog clamp	49
DOYEN, intestinal clamps	87	GLUCK, rib shears	126
DOYEN, ovum forceps	230	GOOD, tonsil scissors	25
DOYEN, probes	66	GORNEY, suction instruments	163
DOYEN, towel clamps	48	GOSSET, abdominal retractors	84
DOYEN, vaginal specula	104	GRAEFE, fine wound retractor	69
DUROGRIP, Wire Holding forceps	149	GRAVE, vaginal specula	102
DURROTIP, Cutting Pliers	152	GROSS, dressing forceps	43
DURROTIP, Cutting Pliers	153	GUEDEL-NEGUS, laryngoscope	08
DURROTIP, Wire Cutters Cutting Scissors	151	GUTHRIE, fine wound retractor	69
DUVAL-COLLIN, Intestinal Grasping Forceps	46	GUYON, kidney clamps	97
DUPLAY, sponge and dressing forceps	43	GERALD, Tissue Forceps	38
DUVAL, intestinal forceps	41	GILLIES, Tissue Forceps	38
		GOLDSMITH, Nasal Specula	91
E		GRAEFE, Tissue Forceps	39
EISELSBERD, needle holder	63	GRAEFE, Tissue Forceps	39
ELSCHING, forceps	37	GRUENWALD, Forceps, Bayonet - Shaped	40
ENGL.MOD, towel clamps	48		
EPPENDORF, biopsy forceps	115	H	
ESMARCH, cloth and plaster scissors	31	HALLE, vascular spatulas	120
EISELSBERG-MATHIEU, Needle Holders	64	HALSTED-MOSQUITO, haemostatic forceps	50
EXTRACTION PLIERS, Wire Holding forceps	150	HARTMANN, intestinal clamps	87

Alphabetical Index

HARVEY, plate scissors	29	KELLY, tissue grasping forceps	44
HAJEK-KOFLER, Punches	130	KERN-LANE, bone holding forceps	143
HALSTED, Haemostatic Forceps	52	KERRISON-JACOBY, punches	129
HALSTED-MOSQUITO, Haemostatic Forceps	51	KERSTING, anastomosis forceps	89
HARTMANN, Ear Polypus Forceps	112	KELLY, Haemostatic Forceps	51
HARTMANN-HALLE, Nasal Specula	91	KERRISON, Punches	130
HARTMANN-HERZFELR, Ear Polypus Forceps	112	KILLIAN, bone shear	26
HARTMANN-HOFFMAR, Ear Polypus Forceps	112	KILLIAN, rectal spatula	90
HARTMANN-WULLSTEIN, Ear Polypus Forceps	112	KILNER, fine dissecting scissors	22
HARVEY, Wire Cutters Cutting Scissors	151	KILNER, fine wound retractor	69
HEANEY, needle holder	62	KILNER, dissecting scissor	22
HEGAR, needle holder	62	KILLIAN, Nasal Specula	90
HEGAR-OLSEN, needle holder	63	KIRSCHNER, Cutting Pliers	154
HEGER, uterine dilators	106	KIRSCHNER, Wire Extension	147
HEISS, haemostatic forceps	50	KOCHER, Haemostatic Forceps	52
HEISS, dressing forceps	58	KOCHER, Haemostatic Forceps	54
HEISTER, mouth gag	05	KOCHER-OCHSNER, Haemostatic Forceps	55
HENING, plaster spreader	157	KLIMA ROSEGGER, trocars	100
HERGET, biopsy forceps	113	KOCHER, retractor	71
HERTZLER, abdominal retractors	84	KOCHER, bladder retractors	99
HERTZLER, rib spreaders	127	KOCHER, bone retractor	74
HESS, tissue forceps	37	KOCHER, retractors	75
HEYMANN-KNIGHT, scissors	25	KOLLE, blood lancet	06
HEYWOOD-SMITH, ovum forceps	109	KONIG, elevators	135
HEYWOOD-SMITH, sponge holding forceps	44	KONIG, raspatories	137
HEYWOOD-SMITH, tongue forceps	05	KONISATION SMESSER, retractors	57
HOLLOW NEEDLE, Suction Instruments	159	KRAUSE, biopsy tip	115
HOUSE, Suction Instruments	161	KRISTELLER, vaginal specula	102
HUBER, biopsy forceps	115	KRISTELLER, vaginal specula	103
HUNT, tumor & vessel forceps	32	KRONECKER, suture instruments	65
HUNTER, splinter forceps	42	KRONLEIN, haemostatic forceps	56
		KUMMEL, intestinal spatula	80
I		L	
INGE, lamina spreaders	83	LABORDE, tracheal dilators	119
INTEROSSEOUS, cartilage knife	12	LAHEY, artery traction forceps	47
IVES-FANSLER, anoscopies	92	LAHEY, gall duct forceps	94
J		LANE TRETOWAN, bone levers	136
JACKSON BURROWS, retractors	82	LANE, bone holding forceps	143
JACOBSON, bone curettes	139	LANE, bone levers	136
JACOBSON, needle holder	61	LANE, tissue forceps	41
JAEGAR, fine wound retractor	69	LANE, towel clamps	48
JAMESON, dissecting scissor	22	LANGE-HOHMANN, bone levers	136
JAMESON, needle holder	62	LANGENBACK, bone levers	135
JANSEN, bone curettes	139	LANGENBECK, with triangle handle	70
JANSEN, bone rongeurs	144	LANGENBECK, flap knife	12
JOHNS-HOPKING, bulldog clamps	49	LARYNGEAL MIRRORS	06
JOLL (FRIEDMAN), retractors	82	LAWRENCE, ligature forceps	58
JOLL, vaginal retractors	105	LANDOLT, Suction Instruments	160
JONES, towel clamps	48	LANDOLT, Suction Instruments	161
JOSEPH, bone file	138	LANGENBECK, Ear Curettes	110
JOSEPH, dura and skin retractor	69	LEBSCHKE, rib shears	126
JOSEPH, raspatories	137	LEGUEU, bladder retractors	99
JUDD-MASSON, bladder retractors	99	LEKSELL-STILLE, bone rongeurs	145
JANSEN, FORCEPS, Bayonet - Shaped	40	LERICHE, intestinal spatula	80
		LEWIS, bone file	138
K		LISTER, bandage scissor	30
KADER, intestinal spatula	80	LISTER, cloth scissor	30
KALT, needle holder	61	LISTER, sponge forceps	43
KELLY, ovum forceps	109	LISTON, bone cutting forceps	146
KELLY, anoscopies	92		

Alphabetical Index

LOCKHART-MUMMERY, probes	66	MULLER, dura and skin retractor	69
LOCKWOOD, Intestinal Grasping Forceps	46	MURPHY, head band	03
LUCAE, FORCEPS, Bayonet – Shaped	40	MUSEUX, tissue grasping forceps	47
LUER, Retractors	73	N	
LOCKLIN, delicate scissor	25	NASAL SCISSORS	25
LOPEZ-REINKE, suction instruments	163	NAUJOKS wire scissors	29
LOWER, gall duct forceps	94	NAIL SPLITTING, Finger Nail Instruments	155
LOWMAN, bone clamps	143	NEEDLE HOLDER, for micro surgery	48
LOWMAN-GERSTER, bone clamps	143	NEGUS, tonsil forceps	57
LOWMAN-HOGLUND, bone clamps	143	NELATON, probes	66
LUCAS, gouges	141	NELSON, lung dissecting forceps	41
LUER-KORTE, gall stone scoops	80	NISSEN, gall duct forceps	94
LURE, bone rongeurs	144	NOTO, ovum forceps	109
M		NOTO, sponge holding forceps	44
MAGILL, laryngoscope	07	NOVAK-SCHOECKAERT, biopsy curettes	111
MALTZ, rasps	138	NOYES, micro spring scissor	15
MANNERFELT, osteotomes	141	O	
MANNERFELT, retractors	70	OLIVECRONA, dura scissors	24
MARTIN, uterine probes	107	OLIVECRONA, trigeminal knife	13
MARTINI, bone curettes	139	OTOSCOPE SETS	07
MASING, retractors	71	OTOSCOPE, Diagnostic Sets	07
MASSON, needle holder	62	P	
MASSON-LUETHY, needle holder	62	PARTSCH, raspatories	137
MATHIEU, retractors	72	PARTSCH, gouges	141
MAYO, dissecting scissors	23	PARTSCH, raspatories	137
MAYO, uterine probes	107	PAYR, pylorus clamps	86
MAYO-HARRINGTON, dissecting scissors	23	PEAN, haemostatic forceps	57
MAYO-NOBLE, dissecting scissors	23	PEAN, haemostatic forceps	51
MAYO-STILLE, dissecting scissors	23	PEAN, kidney clamps	97
MARTIN, Nasal Specula	90	PEDERSON, vaginal specula	102
MATHIEU, Needle Holders	64	PEET, splinter forceps	42
MATHIEU-STILLE, Needle Holders	64	PELKMANN, uterine dressing forceps	108
MC INDOE, forceps	34	PERKINS, self retaining retractors	81
MC KENTY, raspatories	137	PIERCE, trocars	100
MEAD, mallets	140	PINARD, wooden stethoscope	02
MC INDOE, Tissue Forceps	38	PLESTER, retractors	81
MCINTOSH, laryngoscopes	09	PLESTER, suction instruments	163
MEDIUM, Dissecting Forceps	35	POOL, suction instruments	162
MICRO-HALSTED, Haemostatic Forceps	51	POTTS-SMITH, cardiovascular scissor	24
MILLIN, Needle Holders	64	PROBES	67
MICHEL, laryngeal mirrors	06	PARKER, Retractors	73
MICRO SCISSORS, laterally angled	17	PEAN, Haemostatic Forceps	52
MICRO-ADSON, forceps	33	PEAN, Haemostatic Forceps	53
MICRO-ADSON, forceps	37	PEAN, Haemostatic Forceps	54
MIDDELDORPF, retractors	75	PENNINGTON, Tissue Grasping Forceps	45
MIKULICZ, tissue forceps	57	PROVIDENCE-HOSPITAL, Haemostatic Forceps	51
MIKULICZ, intestinal spatula	80	Q	
MIKULICZ, retractors	78	QUERVAIN, bone levers	113
MILLER, laryngoscope	08	R	
MILLIN, bladder retractors	99	RABINER, neurological hammer	01
MIXTER, ligature forceps	58	RANDALL, biopsy curettes	111
MOD.USA, plaster spreader	127	RANDALL, kidney stone forceps	98
MORRIS, anastomosis clamps	89	RECAMIER, uterine scoops	116
MOYNIHAN, haemostatic forceps	57	REYNOLDS, dissecting scissors	22
MOYO-HEGAR, needle holder	62	RICHTER, vaginal retractors	105
MOD. WIEN, Nasal Specula	91	ROCHESTER-CARMALT, haemostatic forceps	57
MOLTGEN, Examination & Measuring Instruments	10	ROEDER, towel clamps	48
MULLAR, Wire Cutting Plier With T.C. Inserts	187		
MULLER LIGATURE FORCEPS	49		
MULLER VESSEL CLIPS	49		

Alphabetical Index

ROUX, retractors	72	STERBERG, Retractors	
RUDD, haemorrhoidal ligator	93	STRULLY, cardiovascular scissors (pointed)	24
RUMEL, dissecting forceps	58	SUCTION INSTRUMENTS	162
RUSS-MODELL, tissue forceps	41	SURGICAL SCISSORS, incision	21
ROHRSCHEIDER, needle holder	61	SURGICAL SCISSORS, serrated	20
ROLLET, dura and skin retractor	69	SURGICAL SCISSORS, slender type	20
ROSER KONIG, mouth gag	05	SURGICAL SCISSORS, standard	20
RAMPLEY, Tissue Grasping Forceps	45	SURGICAL SCISSORS, standard	20
RANKIN, Haemostatic Forceps	52	SUTURING INSTRUMENT SET	68
REILL, Cutting Pliers	152	SYSTRUNK, nail splitting scissors	21
REPLACEMENT LAMP, laryngoscopes	09	SPENCER-WELLS, Haemostatic Forceps	
ROCHESTER-OCHSNER, Haemostatic Forceps	54	SYSTRUNK, Finger Nail Instruments	
ROCHESTER-PEAN, Haemostatic Forceps	53		
ROSE, Retractors	73		
ROUND PLIERS, Wire Holding forceps	150		
S		T	
SAENGER, ovum forceps	118	TAKAHASHI, rongeur	112
SAMII, tumor grasping forceps	32	TAYLOR, percussion hammer	01
SATINSKY, vena cava scissors	24	TAKAHASHI, Rongeurs	132
SAUPE, cilia forceps	42	THOREK, cardiovascular scissors	24
SCALPEL HANDLES	14	THORPE, corneal forceps	33
SCHAAF, cilia forceps	42	TIECK-HALLE, Nasal Specula	90
SCHAEDEL, towel clamps	48	TOENNIS, Wire Cutting Plier With T.C. Inserts	187
SCH EINMANN, biopsy forceps	115	TOWNLEY, Examination & Measuring Instruments	10
SCHIMMELBUSCH, ether mask	05	TOBOLD, tongue depressors	04
SCHMID, vascular spatulas	120	TOENNIS ADSON, dissecting scissors	22
SCHOEMAKER-LOTH, needle holder	63	TOENNIS, dissecting scissors	22
SCHOENBORN, retractors	71	TOENNIS, fine wound retractor	69
SCHRODER, uterine scoops	116	TOENNIS, vascular spatulas	120
SCHUMACHER, rib shears	126	TOENNIS, needle holder	63
SCHUMACHER, umbilical scissors	28	TRELAT, raspatories	137
SCHUMASHER, biopsy forceps	114	TRIGEMINAL KNIFE	13
SCOVILLE-RICHTER, retractors	67	TROCARS	100
SEGOND, myomatome	13	TROEMNER, percussion hammer	01
SEIDL, vaginal specula	102	TROUSSEAU, tracheal dilators	119
SEIDL-DBP, biopsy forceps	114	TROCAR, Suction Instruments	159
SELLORS, rib spreaders	128	TROELTSCH, FORCEPS, Bayonet - Shaped	40
SEMKEN, dissecting forceps	34	TUFFIER, rib spreaders	127
SEMKEN, tissue forceps	37	TUTTLE, lung dissecting forceps	41
SENN-MILLER, Retractors	73		
SEUTIN, plaster scissor	31	U	
SHAPLEIGH, Ear Curettes	110	UMBILICAL CORD SCISSORS	28
SIMON, uterine scoops	116	UNIVERSAL BANDAGE SCISSORS	30
SIMPLEX, tongue depressor	04	UNIVERSAL TROCARS	100
SIMPSON, uterine probes	107	US-ARMY, retractors	72
SIMPSON-BRAUN, obstetrics forceps	117		
SIMS, gynaecology scissors	27	V	
SIMS, vaginal specula	102	VANNAS, micro spring scissors	15
SIMS, rectal specula	90	VERNIER, Examination & Measuring Instruments	10
SIMS, uterine probes	107	WISE GRIP, Wire Holding forceps	150
SMOOTH JAWS FORCEPS	34	VOLKMANN, bone curettes	139
ST.MARTIN, tissue forceps	37	VOLKMANN, bone retractors	74
STEMBERG, tongue depressor	04		
STIEGLITZ, splinter forceps	42		
STILLE, bone rongeurs	145		
STILLE-AESCLAP, plaster shears	156		
STILLE-RUSKIN, bone rongeurs	145		
STRACK, wire scissor	29		
STRASSBURGER Tissue forceps	41		
STANDARD, Dissecting Forceps	35		
STANDARD, Tissue Forceps	39		

Alphabetical Index

W

WANGENSTEEN, needle holder	62
WARTENMERG, pinwheel	01
WAGNER, Rongeurs	134
WAUGH, Tissue Forceps	38
WEBER, anastomosis clamps	124
WECKER, eye scissors	15
WEIL-BLAKESLEY, rongeurs	112
WEITLANER, self retaining retractors	81
WERTHEIM, gynaecology scissors	27
WERTHEIM, clamps and forceps	59
WERTHEIM-CULLEN, vaginal clamps	60
WIEDER, tongue depressor	04
WEIL-BLAKESLEY, Rongeurs	132
WILLIGER, bone curettes	139
WILLIGER, elevators	135
WILLIGER, raspatories	137
WINTER, ovum forceps	118
WILDE, Forceps, Bayonet – Shaped	40
WOLFF, plaster breakers	157
WULLSTEIN, retractors	81
WULLSTEIN, Suction Instruments	160

Y

YASARGIL, needle holder	61
YASARGIL, tumor grasping forceps	32
YASARGIL-SAMII, tumor grasping forceps	32
YASARGIL, Suction Instruments	160
YASARGIL, Suction Instruments	161
YASRGIL, micro scissors	17
YEOMAN, biopsy forceps	113
YOUNG, tongue forceps	05
YOUNG– HRYNTSCHAK, Needle Holders	64
YOUNG-MILLIN, Needle Holders	64

Z

ZENKER, ligature	58
ZENKER, retractors	77
ZIEGLER, head band	03
ZIEGLER, head mirror	03



**P.O. BOX 1365,
Daska Road Addah,
Sialkot - 51310, Punjab PAKISTAN**

**Ph: +92-52-6526511
Fax: +92-52-6526992**

**E-mail: info@seasoned.pk
seasoned@brain.net.pk
URL: <http://www.seasoned.pk>**

www.seasoned.pk